

# ANDES 3

User Guide ■■■



right by our customers. ■■■



datamax·oneil



# Contents

<b>General Precautions</b> .....	<b>1</b>
<b>Safety</b> .....	<b>1</b>
<b>1 Getting Started</b> .....	<b>2</b>
1.1 Unpacking the Printer .....	2
1.2 Installing and Charging the Battery Cartridge .....	3
1.2.1 Installing the Battery .....	3
1.2.2 Charging the Battery .....	4
1.3 Reading the LED Status .....	5
1.4 Attaching Belt Loop System .....	6
<b>2 Loading Supplies</b> .....	<b>7</b>
2.1 Adding Paper or Labels .....	7
2.2 Tearing Paper .....	8
<b>3 Using the Printer</b> .....	<b>9</b>
3.1 Initial Power-Up and Self-Test .....	9
3.2 Connecting the Printer .....	10
3.2.1 Dip Switches Location .....	10
3.2.2 Setting Dip Switches .....	11
3.2.3 Dip Switch Functions .....	11
3.3 Communications .....	12
3.3.1 Serial Communications Specification .....	12
3.4 Infrared Communications Mode (IrDA) .....	13
3.5 Bluetooth/802.11b Communications (Option) .....	13
3.6 Magnetic Stripe Reader (Option) .....	13
3.7 Programming Information .....	14
3.7.1 ASCII Control Characters .....	15
3.7.2 Printer Font Commands .....	15
3.7.3 Printer Font Commands – Character Set .....	15





3.7.4	Printer Graphic Commands .....	16
3.7.5	Magnetic Card Reader Control Commands (When MCR is installed) .....	16
3.7.6	Smart Card Reader Control Commands (when SCR is installed) .....	17
3.7.7	Graphic Logo and Bar Code Commands.....	17
3.7.8	Printer Supervisory and Control Commands.....	17
<b>4</b>	<b>Printer Maintenance.....</b>	<b>19</b>
4.1	Print Head Cleaning Instructions .....	19
4.2	Charging the Printer Battery .....	19
4.2.1	Important Notes on Charging Batteries.....	20
4.2.2	Important Notes on Replacing Batteries .....	20
4.3	Verifying Battery Charge State .....	20
4.4	Battery and Safety Information .....	21
4.5	Recycling Batteries .....	21
4.6	Troubleshooting .....	22
4.7	Printer Supplies.....	23
<b>5</b>	<b>Specifications.....</b>	<b>25</b>
5.1	Printer Specifications .....	25
5.2	Supply Specifications .....	25
5.3	Regulatory Notes.....	26
5.3.1	FCC Part 15 Class B .....	26
5.3.2	Warranty.....	26
5.3.3	Warranty and/or Repair Service.....	26
<b>6</b>	<b>Customer Support .....</b>	<b>27</b>

## General Precautions

- Before using this product be sure to read through this manual. After reading please keep the manual in a safe place for future reference.
- The information contained herein is subject to change without notice of any type.
- Datamax-O'Neil is not responsible for any operational results regardless of missing information, errors or any misprinting in this manual.
- Datamax-O'Neil is not responsible for problems created as a result of using options and consumables not approved by them.
- This product is designed for servicing at an Authorized Service Center. Other than routine maintenance described in this manual the user should not attempt to repair, service or disassemble this product.
- Incorrect operation, handling or improper operating environments may cause damage or otherwise affect the proper operation of this product. Such actions invalidate the product warranty.

## Safety

In this manual and on the Printer and accessories we make use of internationally recognized safety symbols as follows:

	<b>Caution! Refer to the explanation in this Manual</b>
	<b>Caution! Risk of electric shock</b>
	<b>Double Insulation or Reinforced Insulation</b>
	<b>DC, Direct Current or Voltage</b>
	<b>AC + DC, Current or Voltage</b>

# 1 Getting Started

## 1.1 Unpacking the Printer

The ANDES 3 portable printer is a full featured portable receipt printer designed for varied job environments including field service, field sales, hospitality and restaurants, ticketing and many others where point of service receipts are required. The package contains:

- Printer
- Battery Cartridge
- Universal Adapter (USA,UK, European and Australian plugs) for charging the battery inside the printer
- Belt Loop System and
- Roll of paper supply (already loaded in the printer).

Both cabled and wireless communication is possible.

### Overview

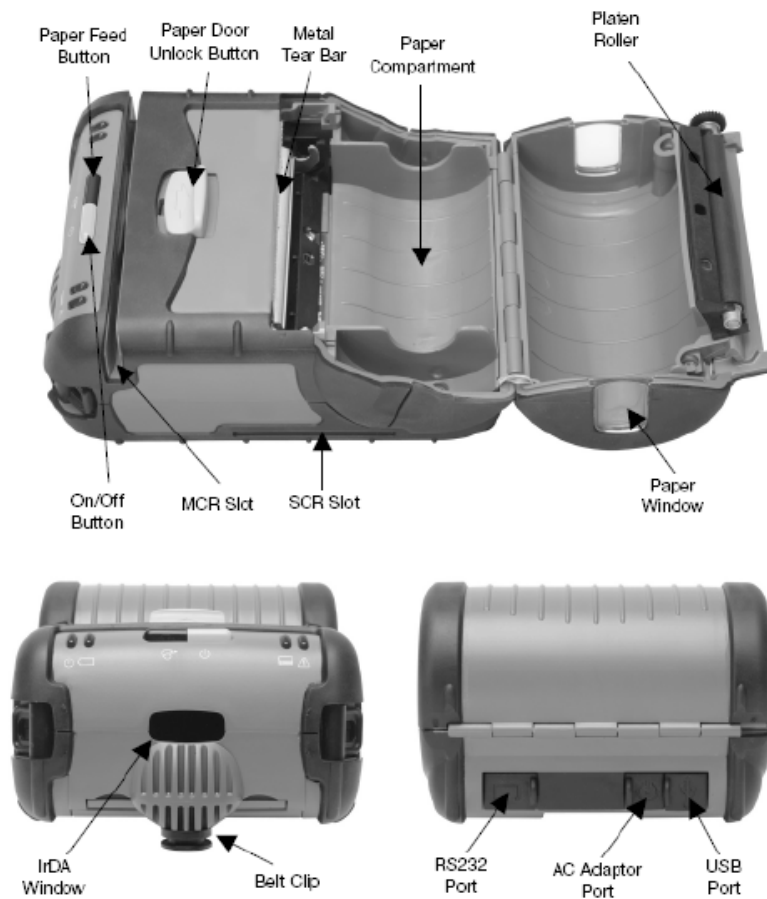

**FIGURE 1: PRINTER OVERVIEW**

## 1.2 Installing and Charging the Battery Cartridge

---

*Note: One battery cartridge is included with the printer. Similar to a cordless phone battery, the printer's battery must be charged before using it.*

---



**Datamax-O'Neil batteries must be cycled several times to achieve maximum capacity. To cycle a battery fully, charge it and then allow full discharge through normal use in the printer.**

### 1.2.1 Installing the Battery

---

*Note: Refer to Figure 2 below to install the battery pack in the printer.*

---

- Unlock the battery door by sliding the battery door locking tab down
- Open the battery door
- Insert the battery as shown. The battery side with two contact terminals should be facing down to make contact with the two spring probes inside the battery compartment.
- Close the battery door.
- Lock the battery door by sliding the battery door locking tab up

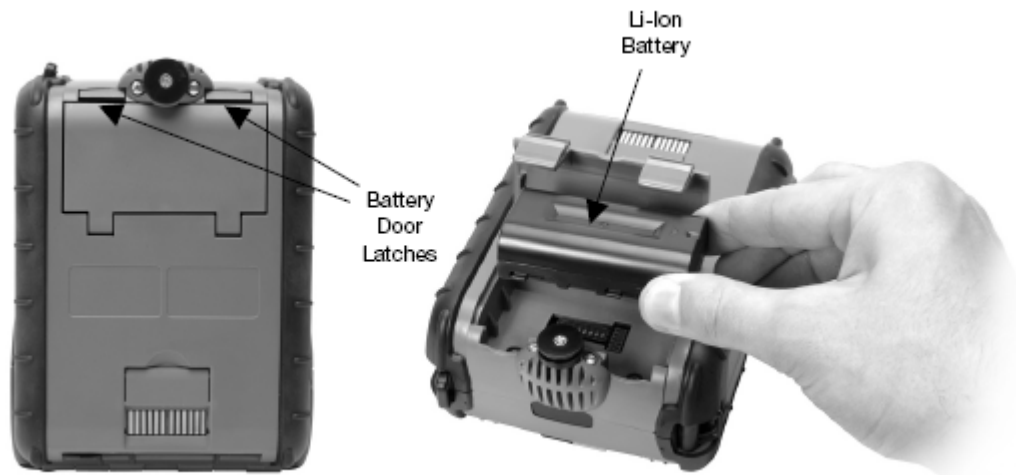

**FIGURE 2: INSTALLING THE BATTERY CARTRIDGE**

---

*Note: Ensure the battery is properly seated before closing door. To ensure a full charge do not operate the printer while charging.*

---

### 1.2.2 Charging the Battery

- Plug battery charger adapter output cable into the battery charger connector as shown in Figure 3.



FIGURE 3 – BATTERY CHARGER

- Plug battery charger adapter into the appropriate AC line voltage socket.
- The Yellow/Amber charging LED will illuminate indicating that the battery is being charged
- The battery will be fast charged and after about 180 minutes. The LED will turn off
- To remove the battery cartridge, open the battery door and tip the battery out of the printer.

---

*Note: To ensure a full charge do not operate the printer while charging.*

---



---

*Note: The wall mounted charger is a Class II equipment (□). Multiple plug configurations comply with most international standards. The wall-mounted charger is not supplied with plugs for use in Korea.*

---

<b>Model</b>	ANDES 3
<b>Input Voltage/Current</b>	100-240 VAC/0.4A
<b>Input Frequency</b>	47-63 Hz
<b>Output Voltage/Current (---)</b>	10VDC/1.32A

	<b>Do not use a charger not approved by Datamax-O’Neil for use with the ANDES 3. Use of an unapproved charger could damage the battery pack or the printer and will void the warranty.</b>
	<b>The battery terminals are well recessed inside the printer. Do not allow them to contact conductive material since this may create a short circuit, which could cause injury or start a fire.</b>
	<b>When using the wall mounted charger, ensure the socket outlet is close to the printer and easily accessible during the process. Switch the socket off, pull the charger from the socket, or disconnect the plug from the printer in case of problems.</b>



### 1.3 Reading the LED Status

The illustration below points out the location of the LED indicators described in Table 1.

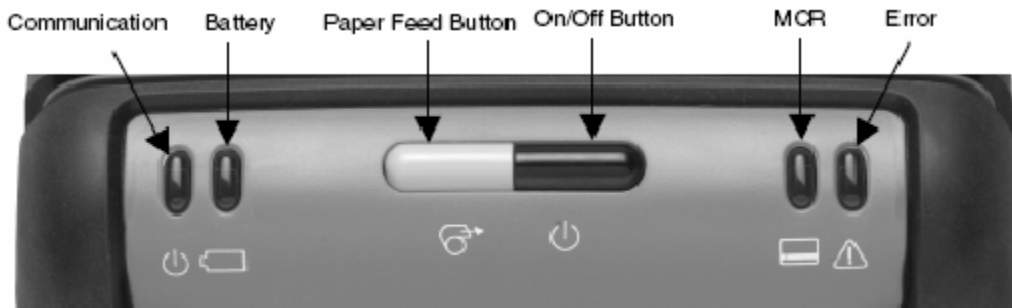

**FIGURE 4 – LED INDICATOR LOCATIONS**

*Note: Refer to the Troubleshooting guide to determine error or fault condition.*

Table 1 explains the LED indicator status. Refer to Figure 4 for the locations described for ON/OFF and FEED pushbutton switches and AC adapter socket

**Table 1 - Reading the LED Status**

LED	Status	Condition	Function
Communication	Green	Flashing	RS232 serial mode selected
		Steady	Communicating with host
	Blue	Flashing	Bluetooth mode selected
		Steady	Transmitting/Receiving
	Amber	Flashing	802.11b/g mode selected
		Steady	Transmitting/Receiving
Error	Red	Steady	Error
Battery	Red	Steady	Low Battery
	Amber	Steady	Battery being charged
	Green	Steady	Battery charge complete
Magnetic Card Reader (MCR)	Green	Steady	Swipe Ready
	Red	Steady	Swipe Error

## 1.4 Attaching Belt Loop System

The belt loop system consists of two parts as seen in Figure 5:

- A knob located on the back part of the printer just above the battery door
- A strap with click on connector

To attach the strap to the knob insert the knob located at the bottom of the printer into the slot of the connector. Pull down until you hear a click. The printer is now secure. The loop is then placed over your belt. Allow the printer to hang down to either the left or right hip.

- To release the printer, press in on the two latches on the connector and pull the knob clear of the slot.

---

*Note: Do not force or pull the printer from the connector without pressing in on the two latches*

---

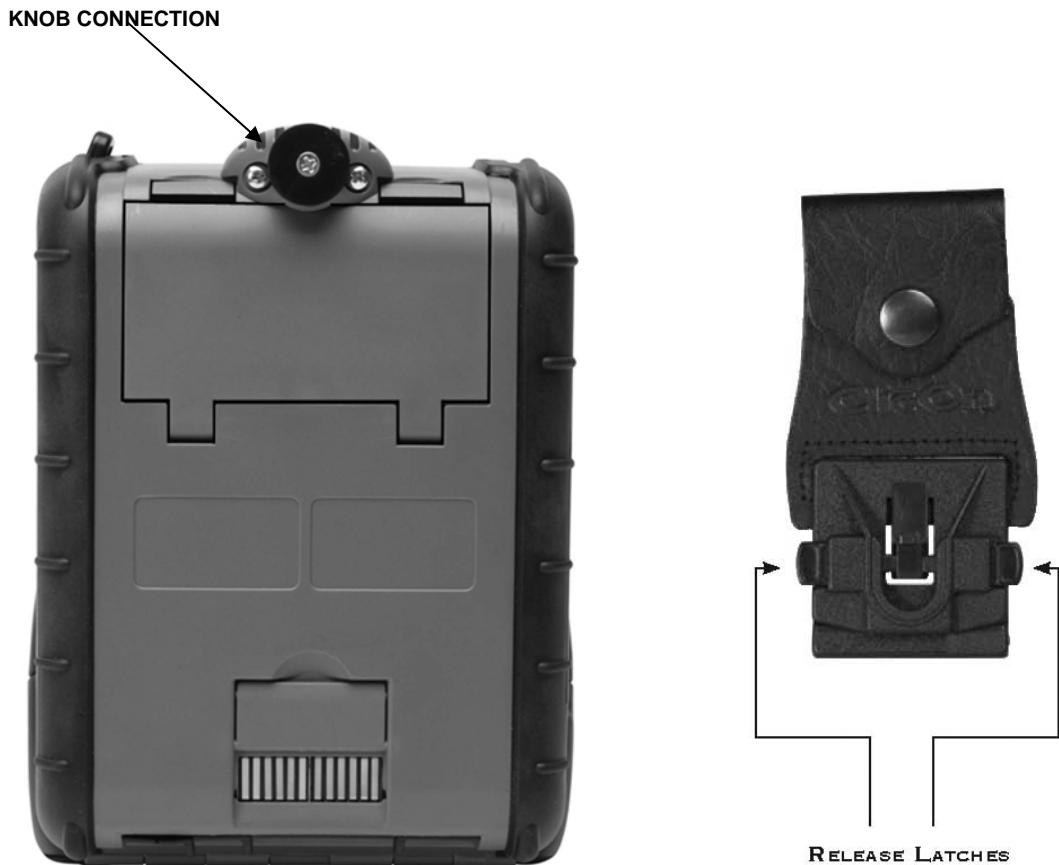

**FIGURE 5– KNOB CONNECTION AND QUICK CLIP**

## 2 Loading Supplies

### 2.1 Adding Paper or Labels

The printer can print text, bar codes and graphics on thermal receipt paper. See “Supply Specifications” for the width, thickness requirements and approved vendors. Follow these steps to load printer paper.

- Open the paper door by pressing the Paper Door Unlock Button on the top cover as indicated in Figure 6.



**FIGURE 6 – OPENING PAPER DOOR**

- Place the paper supply roll into the paper supply well. Make sure the paper supply unwinds from the bottom as shown in Figure 7.

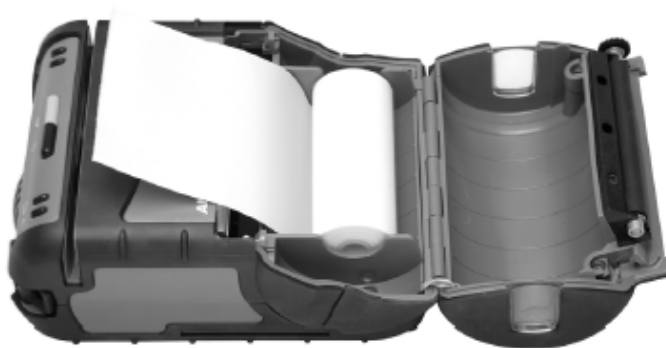

**FIGURE 7 – INSTALLING PAPER ROLL**

- Position the paper supply between the print head guides.
- Make sure some supply (2-3 inches) extends beyond the top of the paper supply well.

- Close the paper door and press close as shown in Figure 8.

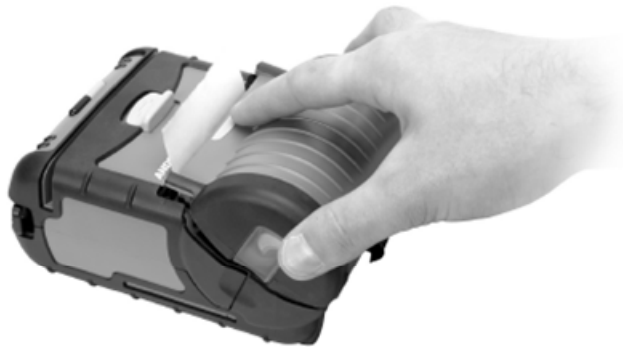

FIGURE 8 – CLOSING PRINTER

## 2.2 Tearing Paper

The printer's paper door acts as a tear bar. Pull one edge of the paper against the tear bar as indicated, then tear down and across against the tear bar to tear the paper. See Figure 8 for details.



FIGURE 9 - TEARING PAPER



**The tear bar may have sharp edges.**

---

*Note: Using the tear bar is the only way to tear the paper.*

---

*Note: Pulling up and pulling sideways without using the tear bar can cause a paper jam due to paper misalignment in the print head mechanism.*

---

# 3 Using the Printer

## 3.1 Initial Power-Up and Self-Test

Once the Battery is charged and the paper is loaded, an initial power up and self-test can be performed:

- Press the <On/Off> switch once. This turns printer on. LED #1 illuminates in green, blue or orange depending on the mode of communication.
  - *The printer will stay ON until it is manually tuned OFF.*
  - *If the printer is set for infrared communications (IrDA) mode the printer will stay on all the time. Pressing the <On/Off> switch again will turn the printer off.*
- Press the <On/Off> switch to turn the printer off. The LED turns off.
- To start the self-test, press and hold the <FEED> switch then press the <On/Off> switch
- The printer will start printing the self-test message. Release the <FEED> and <On/Off> switches.
  - *Press the <On/Off> or <FEED> switch to stop the self-test print.*
  - *The first few lines of self-test show the printer firmware version, the current printer settings (for example IrDA or Serial mode) and a list of any optional or special features installed. See Figure 10 for details.*

```
Power Timer: OFF, Manual Mode  
RS232C Mode: 57.5K, 8, N, 1
```

LIST OF INSTALLED FONTS:

```
=====
k0 - COURIER0 - ROTATED 36 COLUMNS
      ~~~~~~
k1 - COURIER1 - 36 COLUMNS  AbCd0123
k2 - COURIER2 - 48 COLUMNS  AbCd0123
k3 - COURIER3 - 57 COLUMNS  AbCd0123
k4 - COURIER4 - 64 COLUMNS  AbCd0123
k5 - COURIER5 - 72 COLUMNS  AbCd0123
k6 - MONOSPACE821BT_18CPI - 28 COLUMNS  AbCd0123
k7 - MONOSPACE821BT_28CPI - 57 COLUMNS  AbCd0123
k8 - MONOSPACE821BT_28CPI_BOLD - 57 COLUMNS  AbCd0123
k9 - MONOSPACE821BT_28CPI_BOLD - 57 COLUMNS  AbCd0123
```

LIST OF INSTALLED BARCODES:

```
=====
CODE-93
CODE-128
CODABAR
INTERLEAVED 2 OF 5
UPC_EAN_JAN
PDF417
```



FIGURE 10 –SELF-TEST

## 3.2 Connecting the Printer

- The ANDES 3 printer supports Serial RS232 and IrDA compatible infrared communication interfaces. Radio frequency (RF) Bluetooth™ communication is available as an optional feature as well as 802.11 interfaces.
- Serial, IrDA, Bluetooth and 802.11b communication settings can be changed via a DIP switch located on the control card.
- Printer drivers for Windows 95/98/NT/2000 and XP are available from Datamax-O'Neil.
- PrinterCE print Control utility is available from Datamax-O'Neil for Windows CE devices. Printboy Print Utility from Bachmann Software or PalmPrint Utility, from StevensCreek, are recommended for Palm Pilot devices

### 3.2.1 Dip Switches Location

- The DIP switch is located inside the battery compartment as illustrated below indicating the location of this switch. To access to the dip switches open the battery door and remove to battery to access to the DIP – SWITCH. Figure 11 shows the DIP – SWITCH location.
- The functions assigned to these switches are shown in Table 2.

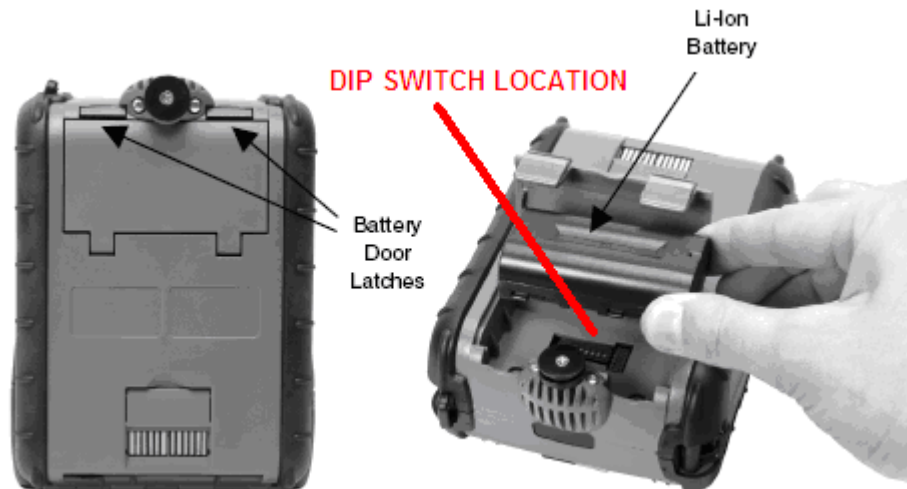

FIGURE 11 - DIP SWITCH LOCATION

---

*Note: Ensure battery is properly seated before closing the door*

---

- If the Serial interface is selected, the communication Parameters, Baud Rate, Data Bit and Parity must be set.

---

*Note: Optional serial cable is available for Serial RS232 communication (Part # 5892RJD9).*

---

### 3.2.2 Setting Dip Switches

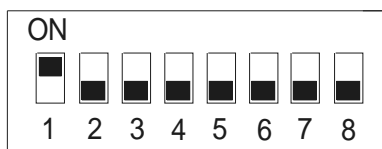

FIGURE 12: EXAMPLE: DIP SWITCH #1 SHOWN IN 'ON' POSITION

*Note: Use care when changing dip switch settings. Carefully use a pointer on the dip switch you are going to change. DO NOT use a screw driver or apply excessive force.*

### 3.2.3 Dip Switch Functions

*Note: (Developer's refer to Programming Manual for more information)*

Table 2 – DIP Switch Setting

Dip Switch	Function	Switch #	Switch #	Switch #	Notes
1 & 2	Communication Interface	SW 1	SW 2		
	RS232	OFF	OFF		Baud rate set by Dip switches 3,4 and 5
	IrDA	ON	OFF		Baud Rate can be negotiated up to the value specified through Dip switches 3,4 and 5
	Bluetooth	OFF	ON		BT Baud Rate set for 57600 bps. Dip switches 3,4 and 5 must be set to OFF position
	802.11b	ON	ON		802.11 Baud Rate set for 57600 bps Dip switches 3,4 and 5 must be set to OFF position
3 & 4 & 5	Baud Rate	SW 3	SW 4	SW 5	
	57600	OFF	OFF	OFF	
	38400	OFF	ON	OFF	
	19200	ON	ON	OFF	
	14400	OFF	OFF	ON	
	9600	ON	OFF	ON	Use for fixed IrDA
	2400	OFF	ON	ON	
	1200	ON	ON	ON	
6	Parity Bit	SW 6			
	Parity Enabled	ON			Does not apply for IrDA
	Parity Disabled	OFF			Does not apply for IrDA
7	Odd/Even	SW 7			
	Even Parity Checker	ON			Does not apply for IrDA
	Odd Parity Checker	OFF			Does not apply for IrDA
8	Auto Power Save	SW 8			
	Power Save Disabled	OFF			Manual On/Off
	Power Save Enabled	ON			Auto Power Down

*Note: In order for changes to the dip switch configuration to take effect, the printer power must be reset. This action occurs automatically when the battery is removed to gain access to the dip switches.*

### 3.3 Communications

- The ANDES 3 Printer is able to support two modes of communication simultaneously – Either RS232 and IrDA (If Dip switch #1 is ON) or RS232 and 802.11b or Bluetooth™ (If Dip switch #1 is OFF and Dip Switch #2 is ON).
- Dip Switch #2 is used to control the RS232 Port. If the Switch is turned ON the RS232 port is disabled and if it is turned OFF the RS232 Port is enabled. If RS232 interface is not required, disabling the port will save battery power.
- Bluetooth or 802.11 RF communications is available if optional daughter boards are installed. The printer can have either Bluetooth or 802.11 enabled but not both of them at the same time.

#### 3.3.1 Serial Communications Specification

- The RS232C Interface signals for the ANDES 3 Series printers are terminated on a 6 PIN RJ type data connector located on the side of the printer.
- Six connections are provided from the Serial Interface to the host computer. The Table 3 below lists the Serial Interface signals and pin outs on the RJ connector and the connector pin locations are shown in Figure 13.
- A minimum of two connections are required for operation: RXD – pin 3 and Common – pin 1

---

*Note: The communication parameters Baud Rate, Data Bit, and Parity must be set to the same settings as the host device.*

---

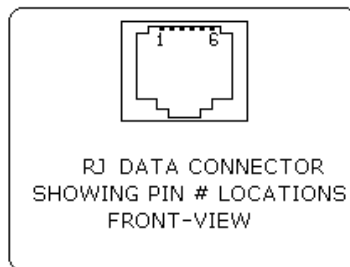

**FIGURE 13 – RJ DATA CONNECTOR**

**TABLE 3 – ANDES 3 - Serial RS232C Interface signals**

RJ25 CONNECTOR PIN #	FUNCTIONAL DESCRIPTION	SIGNAL NAME
3	RS232 from Host (INPUT)	RXD
2	RS232 from Printer (OUTPUT)	TXD
6	Request to send from Host (INPUT)	RTS
4	Clear to send from Printer (OUTPUT)	CTS
1, 5	Logic common	COM



### 3.4 Infrared Communications Mode (IrDA)

- Dip Switch #1 must be in the <ON> position.
- The printer can be powered up by pressing the power <On/Off> switch
- If no IrDA connection is made, the printer will automatically power down to a lower power level to conserve battery life. It will remain in a “sleep” mode until an IrDA connection is made, at which time the printer will “wake” up and print the requested data
- Pressing the power switch again will turn the printer <OFF>.

### 3.5 Bluetooth/802.11b Communications (Option)

- Bluetooth operation: Dip Switch #1 must be in the <OFF> position.  
Dip Switch # 2 must be in the <ON> position.
- 802.11b operation: Dip Switch #1 and #2 must be in the <ON> position.

---

*Note: Adjust baud rate settings to match those of the BT or 802.11b module in your computing device*

---

- The printer can be powered up by pressing the power <On/Off> switch
- Pressing the power <On/Off> switch again will turn the printer <OFF>.

---

*Note: It is necessary for the mobile computing device you are using to discover the printer. Refer to the instructions provided by the systems integrator.*

---

*Note: Systems Integrators: Refer to the Bluetooth manual provided with your mobile computer and the Bluetooth section of the Developer's Manual/802.11b Application Note available for this printer.*

---

### 3.6 Magnetic Stripe Reader (Option)

- The Magnetic Card Reader is a factory-installed option. This option requires special application software to read and process cards with a magnetic stripe, such as credit cards or driver's license

---

*Note: Refer to the Figure 14 if your printer is equipped with the optional magnetic stripe reader*

---

- Quickly swipe the card through the reader either left to right or right to left. The magnetic stripe must be facing toward the paper supply door as indicated below while it is passed through the reader
- Refer to Table 4 for the description of the LED indicator Status.

**Table 4 - Magnetic Card LED Indicator**

LED Indicator	State	Status
Green	ON	Ready/waiting for card to be swiped.
	OFF	Good swipe - Card data read OR Card not ready to be swiped.
Red	ON	Error reading card's data.



**FIGURE 14: USING THE MAGNETIC CARD READER**

### **3.7 Programming Information**

This section lists the printer control commands strings.

---

*Note: System Developers: Please refer to ANDES 3 developer's manual for further details. Other features may be available and are described in the Developer's manual*

---

### 3.7.1 ASCII Control Characters

Character	Hex/Dec	CONTROL ACTION
EOT	04/04	End Of Text
BS	08/08	Back Space
HT	09/09	Horizontal Tab
LF	0A/10	Line Feed
VT	0B/11	Vertical Tab
FF	0C/12	Form Feed
CR	0D/13	Carriage Return
SO	0E/14	Shift Out
SI	0F/15	Shift In
XON	11/17	Transmitter On.
AUXON	12/18	Printer on.
XOFF	13/19	Printer receiver is off
NORM	14/20	Return to default 42 column mode
AUXOFF	15/21	Printer to Host: printer is off
CANCEL	18/24	Cancel and reset printer BUFFER
ESC	1B/27	Escape
EXTEND	1C/28	Extended print
EXTEND OFF	1D/29	Extended print off/Normal print

### 3.7.2 Printer Font Commands

Font Name	PITCH	Character Size (WxH)	Command String	Downloadable
Monospace821BT				
Monospace821BT	20CPI Short Font	10x18	ESC+'k'+ '9'	NO
Monospace821BT	20CPI Bold	10x23	ESC+'k'+ '8'	NO
Monospace821BT	20CPI Normal	10x23	ESC+'k'+ '7'	NO
Monospace821BT	10 CPI Normal	20x23	ESC+'k'+ '6'	NO
Courier				
Courier Mode 5	24 CPI normal	8x23	ESC+'k'+ '5'	YES
Courier Mode 4	21 CPI normal	9x23	ESC+'k'+ '4'	YES
Courier Mode 3	19 CPI normal	10x23	ESC+'k'+ '3'	YES
Courier Mode 2	16 CPI normal	12x23	ESC+'k'+ '2'	YES
Courier Mode 1	12 CPI normal	16x23	ESC+'k'+ '1'	YES
Courier Mode 0	13 CPI rotated	14x16	ESC+'k'+ '0'	NO

### 3.7.3 Printer Font Commands – Character Set

Command String	Printer Action
ESC - 'F' - 1	Selects International character set
ESC - 'F' - 2	Selects PC Line Draw character set
ESC - 'U' - '1'	Enable emphasized print.
ESC - 'U' - '0'	Disable emphasized print.

Table 5 shows the International and PC Line Character sets from 32 through 255.

**Table 5: International and PC Line Draw Character Set**

!	"	#	\$	%	&	'	(	)	*	+	,	-	.	/	0	1	2	3	4	5	6	7	8	9	:	;	<	=	>	?	
@	A	B	C	D	E	F	G	H	I	J	K	L	M	N	O	P	Q	R	S	T	U	V	W	X	Y	Z	[	\	]	^	_
'	a	b	c	d	e	f	g	h	i	j	k	l	m	n	o	p	q	r	s	t	u	v	w	x	y	z	{		}	~	
Ç	ü	é	â	ä	à	ç	ê	ë	è	ï	î	ï	Ä	Å	É	æ	£	ô	ö	ò	û	ü	ÿ	ö	Ü	ø	£	Ø	×	f	
á	í	ó	ú	ñ	Ñ	º	º	¿	↑	↓	½	¼	¡	«	»	§	§	¶	¶	¶	¶	¶	¶	¶	¶	¶	¶	¶	¶	¶	
Φ	Ψ	α	Υ	δ	ε	ã	Ã	¿	η	θ	κ	λ	ε	σ	ς	τ	ν	Ê	Ë	È	Ψ	Í	Î	Ï	ω	ά	έ	ή	ώ	ì	□
Ó	β	Ô	Ò	õ	Õ	μ	ρ	↓	¹	Ù	Ú	ƒ	Ý	ý	ú	ƒ	±	θ	∞	Ω	■	Σ	Π	f	♥	♦	♣	♠	÷	■	

**International Character Set**

!	"	#	\$	%	&	'	(	)	*	+	,	-	.	/	0	1	2	3	4	5	6	7	8	9	:	;	<	=	>	?	
@	A	B	C	D	E	F	G	H	I	J	K	L	M	N	O	P	Q	R	S	T	U	V	W	X	Y	Z	[	\	]	^	_
'	a	b	c	d	e	f	g	h	i	j	k	l	m	n	o	p	q	r	s	t	u	v	w	x	y	z	{		}	~	
Ç	ü	é	â	ä	à	ç	ê	ë	è	ï	î	ï	Ä	Å	É	æ	£	ô	ö	ò	û	ü	ÿ	ö	Ü	ø	£	Ø	×	f	
á	í	ó	ú	ñ	Ñ	º	º	¿	↑	↓	½	¼	¡	«	»	§	§	¶	¶	¶	¶	¶	¶	¶	¶	¶	¶	¶	¶	¶	
Ł	ł	Ł	ł	Ł	ł	Ł	ł	Ł	ł	Ł	ł	Ł	ł	Ł	ł	Ł	ł	Ł	ł	Ł	ł	Ł	ł	Ł	ł	Ł	ł	Ł	ł	Ł	ł
Ó	β	Ô	Ò	õ	Õ	μ	ρ	↓	¹	Ù	Ú	ƒ	Ý	ý	ú	ƒ	±	θ	∞	Ω	■	Σ	Π	f	♥	♦	♣	♠	÷	■	

**PC Line Draw Character Set**

### 3.7.4 Printer Graphic Commands

Command String	Printer Action
ESC - 'a' - n	Select dot line spacing between printed lines.
ESC - 'J' - n	Graphic Line Feed command
ESC - 'P' - '#'	Select Online mode, characters printed as received.
ESC - 'P' - '\$'	Select Buffer mode, characters are printed on (^ D)
ESC - 'V' - n1 - n2	8-bit Graphic command
ESC - 'v' - n1 - n2	RLE Compressed Graphic command

### 3.7.5 Magnetic Card Reader Control Commands (When MCR is installed)

Command String	Printer Action
ESC - 'M' - 'nm' - Cr	Select MCR with (nn) auto timeout Where nn="00" to "99" m=1: Reads track 1 only m=2: Reads track 2 only m=3: Reads track 3 only m=4: Reads track 1 & 2 m=5: Reads track 2 & 3 m=6: Reads track 1, 2 & 3
ESC - 'C'	Cancel MCR read process

### 3.7.6 Smart Card Reader Control Commands (when SCR is installed)

Command String	Printer Action
ESC - 'M' - 'nn' - '7' - Cr	Select SCR in direct mode with Serial RS232. (nn) is the auto timeout of the SCR.
ESC - 'M' - 'nn' - '8' - Cr	Select SCR in PassThru mode with BT/802.11 or IrDA on. (nn) is the auto timeout of the SCR.

### 3.7.7 Graphic Logo and Bar Code Commands

Command String	Printer Action
ESC - L - G - n	Prepare printer to load image:
ESC - G - 0x0FF	Loading Logo Complete:
ESC - L - g - n	Print stored logo image:
ESC - 'z' - n1 - n2 - L - [data]	Print Bar Code without visible text
ESC - 'Z' - n1 - n2 - L - [data]	Print Bar Code with visible text
ESC - 'Q' - 'J' - n	Reverse Dot Feed
ESC - 'Q' - 'Q' - n	Set Out of Paper Sensitivity
ESC - 'Q' - 'F' - m	Set Forward Black Mark Seek
ESC - 'Q' - 'B' - m	Reverse Black Mark Seek

### 3.7.8 Printer Supervisory and Control Commands

Command String	Printer Action
^V	Buffer, power timer & battery status
^B	Buffer status
ESC - 'P' - '^'	Print Battery Voltage
ESC - 'M' - '000' - Cr	disable the power down timer
ESC - 'M' - 'nn0' - Cr	sets the power down timer to nn seconds
ESC - 'M' - 'C'	Reset Auto power down to 20 seconds
ESC - 'P' - '('	Firmware version query
ESC - 'P' - ')''	Hardware model query:
ESC - 'P' - '+' or '-'	Enable or Disable EOT printer response



## 4 Printer Maintenance

### 4.1 Print Head Cleaning Instructions

You may need to clean the print head and platen roller after printing a number of rolls of paper, whenever you load new supplies or when you see voids in the printout.



**Do not use sharp objects to clean the print head. This may damage the printer and require service.**

- Open the paper door by pressing the Paper Door Unlock Button on the top cover as shown in [Figure 4](#). The paper supply door will pop up.
- Remove the paper roll.
- Moisten a cotton swab with isopropyl alcohol and clean the print head
- Clean the platen roller with a dry cloth or small brush

---

*Note: You can also use another cotton swab moistened with isopropyl alcohol. Turn the platen roller with your finger and run the cotton swab or dry cloth across it. Make sure the platen roller is clean all the way around.*

---

- Moisten another cotton swab with isopropyl alcohol. Rub the swab across the black mark sensor to remove any build-up
- Moisten another cotton swab and rub the swab across the tear bar to remove any build-up

---

*Note: You may experience dust build-up depending on the environment and the quality of the paper supply you use. If this occurs, use a can of compressed air to blow dust and paper debris out of the printer.*

---

### 4.2 Charging the Printer Battery

The printer battery is charged using the wall mounted charger provided. Follow these steps to charge the battery pack.

**Note:** Make sure the printer and all LED's are OFF before charging battery.



- Plug the charger into an appropriate wall socket; then plug the charger line cord into the adapter jack on the side of the printer (see [Figure 1](#))
- The yellow CHARGE LED will illuminate, to indicate battery is charging.
- The Charge LED turns off when battery cartridge is fully charged. It takes about 180 minutes to fast charge the battery cartridge
- To insure full charge, printer should not be operated while the battery is charging.

## 4.2.1 Important Notes on Charging Batteries

- The model ANDES 3 printers require an adapter output of 10VDC/1.32A.
- The battery Fast-charge is initiated each time the power adapter is connected to the printer
- The Fast-charge controller checks the battery's voltage and temperature, before the start of the fast recharge process. If the battery voltage or the temperature is outside of the fast-charge limits, the charger defaults to trickle charge at C/10 or 70 mA rate
- Optional external battery chargers are available for Datamax-O'Neil batteries. Refer to [Section 4.7](#) "Printer Supplies" for detailed information.

## 4.2.2 Important Notes on Replacing Batteries

- *Check for the correct Datamax-O'Neil part number for the battery and only use that part for your new battery*

	<b>Risk of explosion if battery is replaced by an incorrect type</b>
	<b>Dispose of used batteries according to instructions in Section 4.5</b>

## 4.3 Verifying Battery Charge State

We strongly recommend testing your printer before returning it to Datamax-O'Neil. Follow these steps to identify and correct any battery power problem that may be encountered. These will help to identify that the fault is with the printer and not some other part of your system.

### To test the AC adapter:

- Use a multi-meter and measure the output voltage. Output should be 10VDC.
- Press the <ON/OFF> switch and wait until all LED's are off.
- Insert the AC adapter plug into the printer. If the amber LED goes on, the battery is not fully charged but the charge circuit is functioning.
- The AC power portion of the circuit appears ok.

### To test the DC power:

- Disconnect the AC Adapter once the battery has charged for 5 minutes or so.
- Press and hold the <FEED> switch, then press and release the <ON/OFF> switch and then release the <FEED> switch. The printer will print a "self test" receipt
- If the self test receipt is printed, the DC power is ok.

### To test if the battery is accepting charge:



- Press <ON/OFF> switch and wait until all LED's are off
- Plug the AC power adapter into the printer. Press <ON>; the green LED is illuminated and after about 20 seconds the LED should go off
- If the amber LED is on, this will continue on through this test indicating that the battery is accepting a charge and that the charge circuit is ok. At the end of a 180 minute charge cycle the LED will go off.

## 4.4 Battery and Safety Information

The printer is powered by a 7.4V Li-Ion battery cartridge.

- Charging time in the printer is approximately 3.0 hours.
- Take the battery out of printer if storing the printer for long periods of time.
- The battery storage temperature is 40°F to 104°F (4°C to 40°C). Do not store a fully charged battery at temperatures greater than 104°F (40°C) for long periods of time – the battery may permanently lose charge capacity.
- The recommended temperature for charging is between 68°F (20°C) to 77°F (25°C).
- Be sure to use a fully charged battery before long or battery intensive printing sessions. Certain operations (for example, printing receipts with a lot of bar codes and graphics) drain the battery more quickly than others.
- Dispose according to your local regulations. **Do not throw in trash.**



**Do not disassemble, short circuit, heat above 80°C, or incinerate: the battery may explode.**

## 4.5 Recycling Batteries

The Rechargeable Battery Recycling Corporation (RBRC) is a non-profit organization created to promote recycling of rechargeable batteries. For more information about how to recycle batteries in your area, visit [www.rbrc.org](http://www.rbrc.org).

## 4.6 Troubleshooting

Problem	Action
Does not feed paper or has a paper jam.	<ul style="list-style-type: none"> <li>▪ Remove any jammed supply</li> <li>▪ Reload paper supply.</li> </ul>
Does not print	<ul style="list-style-type: none"> <li>▪ Check or replace the printer's battery</li> <li>▪ Make sure the paper supply is loaded correctly, not backwards.</li> <li>▪ Verify communication between the host device and the printer by disconnecting the communication cable and performing a printer self test.</li> </ul>
Light printing	<ul style="list-style-type: none"> <li>▪ Check or recharge the battery</li> <li>▪ Adjust the print contrast through print application.</li> </ul>
Voids in printing	<ul style="list-style-type: none"> <li>▪ Clean the print head following the cleaning. Instruction listed in <a href="#">Section 4.1</a>.</li> </ul>
Red (Error) LED on	<ul style="list-style-type: none"> <li>▪ Check that paper roll is not out and paper door is closed.</li> <li>▪ Error reading MCR.</li> <li>▪ After extended printing, print head may be hot; printer will pause before resuming printing.</li> </ul>

If the problem is not identified by following the above trouble shooting guide, contact Datamax-O'Neil Technical Support. Support numbers and Email addresses are listed at [Section 6](#) of this manual.



**Other than routine cleaning and other maintenance described in Section 4, the printer is not intended to be serviced by the user. It must be returned to an Authorized Service Center. Under no circumstances should the user attempt to take the printer apart.**

## 4.7 Printer Supplies

Part Number	Description
79328I1	ANDES 3 PKG
79328I1-1	ANDES 3 PKG with Bluetooth™
79328I1R	ANDES 3 PKG 120 with MCR
79328I1R-1	ANDES 3 MCR PKG with MCR and Bluetooth™
151133	24V In-Vehicle Charger
157261	Multi-Plug Battery Charger Adapter (US, UK, Euro & Australian Plug)
756998-1	Spare Belt Loop System
757068	ANDES 3 Thermal Paper Pack (4" / 100', 5 rolls)
757068-CASE	ANDES 3 Thermal Paper (Case of 100 Rolls)
757150	Thermal Print Head Cleaning Pen
757160	Magnetic Card Reader Cleaning Cards (5 per order)
757352	Shoulder Strap with Quick Clip
767400-1	Battery Charger (2 Bay) Li-Ion 120VAC
767400-2	Battery Charger (2 Bay) Li-Ion 220VAC
767400-4	Battery Charger (2 Bay) Li-Ion 240VAC
7A1000014	Li-Ion Battery Cartridge: 7.4VDC– 2200 mAH
5892RJD9	Serial Data Cable – RJ to DB9 PC compatible
Available from Datamax-O'Neil at <a href="http://www.datamax-oneil.com">www.datamax-oneil.com</a>	Windows 95/98/NT/2000/ Drivers
Download: <a href="http://www.fieldsoftware.com/PrinterCE.htm">http://www.fieldsoftware.com/PrinterCE.htm</a>	Windows CE print Utility
Download <a href="http://www.stevenscreek.com/pilot/dodownload.html">http://www.stevenscreek.com/pilot/dodownload.html</a>	Palm Pilot print Utility



## 5 Specifications

### 5.1 Printer Specifications

Height:	2.5 inches (64mm)
Width:	6.5 inches (167mm)
Length:	7.5 inches (192mm)
Weight: w/battery & supply	1.8 lbs. (850g)
Shipping weight:	3.3 lbs. (1.5kg)
Power:	7.4 V Li-Ion battery
Operating Temp. Limits:	32F to 122F (0 to 50C)
Storage Temp. Limits:	-4F to 140F (-20C to 60C)
Operating Humidity Limits:	20% to 85% non-condensing
Storage Humidity Limits:	5% to 95% non-condensing
Print Width:	4 inches wide (104mm) 203 dpi (8 dots per mm)
Printing Method:	Thermal Direct
Print Speed:	Up to 3.0 inches/sec. @ 7.2v to ph.
Supported Fonts: (Bitmap)	Standard (normal and bold) Large (normal) Reduced (normal and bold) Large rotated.
Supported Bar Codes:	Codabar, Code 39, UCC/EAN – 128, UPC/EAN/JAN, Interleaved 2 of 5, Code 128
Memory:	2M Flash 768K SRAM --- (256K int. -- 512K ext.)
Charging Time:	Approximately 180 minutes
Communications:	RS-232, IrDA, Bluetooth, 802.11b
Print Ratio:	25% black maximum/sq. in.

### 5.2 Supply Specifications

Supplies:	Thermal direct receipt paper
Supply Thickness:	2.2 to 3.5 mils (receipt paper)
Supply Width:	4.33 inches (110mm)
Supply Length:	1 roll of receipt paper is ~100 ft. (30km.)
Supply Sensing:	Black mark (on face of supply)
Paper roll diameter:	Outside: 2.0 inches (51 mm) Inside: 0.40 inches (10 mm)
Approved Vendors	<b>Kansaki:</b> P300, P310, P350, P354, P390, P530UV, TO281CA, OP200, TO381N, F180, F380, F550 <b>Jujo:</b> TF-50KS-E2C <b>Honshu:</b> FH65BV-3

## 5.3 Regulatory Notes

### 5.3.1 FCC Part 15 Class B

This equipment has been tested and found to comply with the limits for a Class B digital device, pursuant to Part 15 of the FCC rules. These limits are designed to provide reasonable protection against harmful interference in a residential installation. This equipment can radiate radio frequency energy and, if not installed and used in accordance with the instructions, may cause harmful interference to radio communications. However, there is no guarantee that interference will not occur in a particular installation. If this equipment does cause harmful interference to radio or television reception, which can be determined by turning the equipment off and on, the user is encouraged to try to correct the interference by one or more of the following measures:

- Reorient or relocate the receiving antenna.
- Increase the separation between the equipment and the receiver.
- Connect the equipment to an outlet on a circuit different from that to which the receiver is connected.
- Consult the dealer or an experienced radio/TV technician for help.

For Bluetooth equipped printers, please note:

- The printer contains an OEM Serial Port Adapter from connectBlue with FCC ID: PVH070101. This device complies with Part 15 of the FCC Rules. Operation is subject to the following two conditions:
  - (1) this device may not cause harmful interference,
  - (2) this device must accept any interference received, including interference that may cause undesired operation."

### 5.3.2 Warranty

This printer is warranted by Datamax-O'Neil to be free of defects in parts and workmanship for a period of one year from date of shipment. This warranty does not apply to defects resulting from action of the user such as misuse, improper wiring, operation outside of specification, improper maintenance or repair, or unauthorized modification. Datamax-O'Neil specifically disclaims any implied warranties of merchantability or fitness for a specific purpose and will not be liable for any direct, indirect, special, incidental or consequential damages. Datamax-O'Neil's total liability is limited to the repair or replacement of the product. The warranty set forth above is inclusive and no other warranty, whether written or oral is expressed or implied.

### 5.3.3 Warranty and/or Repair Service

A Return Authorization number must be issued before a unit is returned to Datamax-O'Neil for repair. Once a unit has been properly returned to Datamax-O'Neil (Note: The customer is responsible for ensuring proper packing to prevent damage in transit as well as the shipping costs back to Datamax-O'Neil), it will be repaired (estimates are provided first if the repair cost is estimated above \$100.00) and returned via UPS ground. The customer may elect a faster mode of transport at their cost.

## 6 Customer Support

Datamax-O'Neil Americas  
Orlando, FL USA  
Monday - Friday  
8:00am - 6:00pm EST  
Tel: 407-523-5540  
Fax: 407-523-5542  
[tech\\_support@datamax-oneil.com](mailto:tech_support@datamax-oneil.com)

Datamax-O'Neil EMEA  
Valence France  
Monday - Friday  
0830 - 1700 GMT  
Tel: + 33 (0) 4 75 75 63 00  
Fax: +33 (0) 4 75 82 98 38  
[eurotech@datamaxcorp.com](mailto:eurotech@datamaxcorp.com)

Datamax-O'Neil Asia-Pacific  
Singapore  
Monday - Friday  
0830 - 1730  
Tel: +65 6505 2250  
Fax: +65 6769 8135  
[tsaspa@datamax-oneil.com](mailto:tsaspa@datamax-oneil.com)

