

PowerScan™ PBT7100 Cordless Imaging Reader



Quick Reference Guide

Datalogic Scanning, Inc.

959 Terry Street

Eugene, Oregon 97402

USA

Telephone: (541) 683-5700

Fax: (541) 345-7140

An Unpublished Work - All rights reserved. No part of the contents of this documentation or the procedures described therein may be reproduced or transmitted in any form or by any means without prior written permission of Datalogic Scanning, Inc. or its subsidiaries or affiliates ("Datalogic" or "Datalogic Scanning"). Owners of Datalogic products are hereby granted a non-exclusive, revocable license to reproduce and transmit this documentation for the purchaser's own internal business purposes. Purchaser shall not remove or alter any proprietary notices, including copyright notices, contained in this documentation and shall ensure that all notices appear on any reproductions of the documentation.

Should future revisions of this manual be published, you can acquire printed versions by contacting your Datalogic representative. Electronic versions may either be downloadable from the Datalogic website (www.scanning.datalogic.com) or provided on appropriate media. If you visit our website and would like to make comments or suggestions about this or other Datalogic publications, please let us know via the "Contact Datalogic" page.

Disclaimer

Datalogic has taken reasonable measures to provide information in this manual that is complete and accurate, however, Datalogic reserves the right to change any specification at any time without prior notice.

Datalogic and the Datalogic logo are registered trademarks of Datalogic S.p.A. in many countries, including the U.S.A. and the E.U. All other brand and product names may be trademarks of their respective owners.

Patents

This product may be covered by one or more of the following patents: 4603262 • 4639606 • 4652750 • 4672215 • 4699447 • 4709369 • 4749879 • 4786798 • 4792666 • 4794240 • 4798943 • 4799164 • 4820911 • 4845349 • 4861972 • 4861973 • 4866257 • 4868836 • 4879456 • 4939355 • 4939356 • 4943127 • 4963719 • 4971176 • 4971177 • 4991692 • 5001406 • 5015831 • 5019697 • 5019698 • 5086879 • 5115120 • 5144118 • 5146463 • 5179270 • 5198649 • 5200597 • 5202784 • 5208449 • 5210397 • 5212371 • 5212372 • 5214270 • 5229590 • 5231293 • 5232185 • 5233169 • 5235168 • 5237161 • 5237162 • 5239165 • 5247161 • 5256864 • 5258604 • 5258699 • 5260554 • 5274219 • 5296689 • 5298728 • 5311000 • 5327451 • 5329103 • 5330370 • 5347113 • 5347121 • 5371361 • 5382783 • 5386105 • 5389917 • 5410108 • 5420410 • 5422472 • 5426507 • 5438187 • 5440110 • 5440111 • 5446271 • 5446749 • 5448050 • 5463211 • 5475206 • 5475207 • 5479011 • 5481098 • 5491328 • 5493108 • 5504350 • 5508505 • 5512740 • 5541397 • 5552593 • 5557095 • 5563402 • 5565668 • 5576531 • 5581707 • 5594231 • 5594441 • 5598070 • 5602376 • 5608201 • 5608399 • 5612529 • 5629510 • 5635699 • 5641958 • 5646391 • 5661435 • 5664231 • 5666045 • 5671374 • 5675138 • 5682028 • 5686716 • 5696370 • 5703347 • 5705802 • 5714750 • 5717194 • 5723852 • 5750976 • 5767502 • 5770847 • 5786581 • 5786585 • 5787103 • 5789732 • 5796222 • 5804809 • 5814803 • 5814804 • 5821721 • 5822343 • 5825009 • 5834708 • 5834750 • 5837983 • 5837988 • 5852286 • 5864129 • 5869827 • 5874722 • 5883370 • 5905249 • 5907147 • 5923023 • 5925868 • 5929421 • 5945670 • 5959284 • 5962838 • 5979769 • 6000619 • 6006991 • 6012639 • 6016135 • 6024284 • 6041374 • 6042012 • 6045044 • 6047889 • 6047894 • 6056198 • 6065676 • 6069696 • 6073849 • 6073851 • 6094288 • 6112993 • 6129279 • 6129282 • 6134039 • 6142376 • 6152368 • 6152372 • 6155488 • 6166375 • 6169614 • 6173894 • 6176429 • 6188500 • 6189784 • 6213397 • 6223986 • 6230975 • 6230976 • 6244510 • 6259545 • 6260763 • 6266175 • 6273336 • 6276605 • 6279829 • 6290134 • 6290135 • 6293467 • 6303927 • 6311895 • 6318634 • 6328216 • 6332576 • 6332577 • 6343741 • 6454168 • 6478224 • 6568598 • 6578765 • 6705527 • 6857567 • 6974084 • 6991169 • 7005190 • 7170414 • 7172123 • 7201322 • 7204422 • 7215493 • 7224540 • 7234641 • 7243850 • 7374092 • 7407096 • 7490770 • 7495564 • 7506816 • 7527198 • 7527207 • 7571166 • 7562817 • 601 26 118.6 • AU7003547 • D312631 • D313590 • D320011 • D320012 • D323492 • D330707 • D330708 • D349109 • D350127 • D350735 • D351149 • D351150 • D352936 • D352937 • D352938 • D352939 • D358588 • D361565 • D372234 • D374630 • D374869 • D375493 • D376357 • D377345 • D377346 • D377347 • D377348 • D388075 • D446524 • D606544 • EP0256296 • EP0260155 • EP0260156 • EP0295936 • EP0325469 • EP0349770 • EP0368254 • EP0442215 • EP0498366 • EP0531645 • EP0663643 • EP0698251 • EP01330772 • EP870761 • GB2252333 • GB2284086 • GB2301691 • GB2304954 • GB2307093 • GB2308267 • GB2308678 • GB2319103 • GB2333163 • GB2343079 • GB2344486 • GB2345568 • GB2354340 • ISR107546 • ISR118507 • ISR118508 • JP1962823 • JP1971216 • JP2513442 • JP2732459 • JP2829331 • JP2953593 • JP2964278 • MEX185552 • MEX187245 • RE37166 • RE40071 • Other Patents Pending

Table of Contents

Statement of Agency Compliance	3
FCC Class B Compliance Statement	3
Canadian Notice	3
Solids and Water Protection	3
Laser Cautions	4
Software Product Policy	4
Getting Started	7
Installing the Battery Pack	7
Verifying Reader Operation Before Linking	9
Linking the Reader to a Base Station	11
Linking the Reader to a <i>Bluetooth</i> [®] Enabled Device	11
Battery Pack Charging and Maintenance	11
Programming	12
Resetting the Standard Product Defaults	12
Defaults	13
Enabled Symbologies	13
How to Scan	14
Troubleshooting	14
Troubleshooting the BT System	14
Troubleshooting the Reader	15

NOTES

Statement of Agency Compliance

This device complies with part 15 of the FCC Rules. Operation is subject to the following two conditions: (1) this device may not cause harmful interference, and (2) this device must accept any interference received, including interference that may cause undesired operation.

FCC Class B Compliance Statement

The user is cautioned that changes or modifications not expressly approved by the part responsible for compliance could void the user's authority to operate the equipment.

This equipment has been tested and found to comply with the limits for a Class B digital device pursuant to part 15 of the FCC Rules. These limits are designed to provide reasonable protection against harmful interference in a residential installation. This equipment generates, uses, and can radiate radio frequency energy and, if not installed and used in accordance with the instructions, may cause harmful interference to radio communications. However, there is no guarantee that interference will not occur in a particular installation. If this equipment does cause harmful interference to radio or television reception, which can be determined by turning the equipment off and on, the user is encouraged to try to correct the interference by one or more of the following measures:

- Reorient or relocate the receiving antenna.
- Increase the separation between the equipment and receiver.
- Connect the equipment into an outlet on a circuit different from that to which the receiver is connected.
- Consult the dealer or an experienced radio or television technician for help.

FCC RF Radiation Exposure Statement

This equipment complies with FCC radiation exposure limits under Specific Absorption Rate (SAR) tests for portable devices operating closer than 20 cm to nearby persons, set forth in an uncontrolled environment. The PowerScan PBT7100 cordless imaging reader has been demonstrated to meet these RF emissions safety limits.

Canadian Notice

This equipment does not exceed the Class B limits for radio noise emissions as described in the Radio Interference Regulations of the Canadian Department of Communications.

Le présent appareil numérique n'émet pas de bruits radioélectriques dépassant les limites applicables aux appareils numériques de la classe B prescrites dans le Règlement sur le brouillage radioélectrique édicté par le ministère des Communications du Canada.

Solids and Water Protection

The reader is rated as IEC 529-IP65. This nomenclature designates the degree of water and dust resistance, indicating the imager is totally protected against dust and is protected against low pressure jets of water from all directions - limited ingress permitted.

The Base Station is rated as IEC 529-IP54, indicating the unit is protected against dust, limited ingress (no harmful deposit) and is protected against water sprayed from all directions - with limited ingress permitted.

Laser Cautions

The imager may contain a laser pointer (this is a value-added option), which is certified in the U.S. to conform to the requirements of DHHS/CDRH 21CFR Subchapter J for Class II and IEC 60825-1 for Class 2 products. Class II (2) products are not considered to be hazardous. Laser pointer models of the imager contain a Visible Laser Diode (VLD) at a wavelength of 635-670 nanometers and is designed so that there can be no human access to harmful levels of laser light during normal operation, user maintenance, or during prescribed service operations. See the User Manual for laser pointer configuration information and barcodes.



CAUTION

Do not attempt to open or otherwise service any components in the optics cavity. Opening or servicing any part of the optics cavity by unauthorized personnel may violate laser safety regulations.

Software Product Policy

Datalogic reserves the right to ship its products with the latest version of software/firmware available. This provides our customers with the very latest in Datalogic software technology.

The only exception to this policy is when the buyer has a signed contract with Datalogic that clearly defines the terms and conditions for making software/firmware changes in products shipped to the buyer. **Datalogic Scanning, Inc.**

POWERSCAN® END USER LICENSE AGREEMENT

Notice to End User: The Datalogic Product you have acquired contains embedded Software, which is integral to the product's operation. This Software is being provided to you under license, subject to the terms and conditions of this Agreement. If you use the Datalogic Product, you will be deemed to have accepted the terms and conditions of this Agreement. If you do not intend to be bound to the terms of this Agreement, Datalogic is not willing to license the Software to you, you may not use the Datalogic Product or the Software, and you must contact the party from whom you acquired the Datalogic Product for instructions.

This End User Software License Agreement ("Agreement") is a legally binding agreement governing the licensing of the Software and Documentation by Datalogic, Scanning Holdings, Inc. and its wholly owned subsidiaries and affiliates ("Datalogic") to the entity or person who has purchased or otherwise acquired a Datalogic Product ("End User"). For purposes of this Agreement, any software that is associated with a separate end-user license agreement is licensed to you under the terms of that license agreement. Datalogic and End User hereby agree as follows:

1. Definitions.

- 1.1 "Documentation" means materials such as user's guides, program reference guides, quick reference guides, manuals, or similar materials associated with or related to the Datalogic Product, whether in printed, "online", or other form.
- 1.2 "Proprietary Information" means: (a) source code, object code, software, documentation, and any related internal design, system design, data base design, algorithms, technology, technical data or information, implementation techniques, and trade secrets related to the Software, (b) any other trade secrets marked appropriately or identified as proprietary or confidential, and (c) any information that End User, under the circumstances, should recognize as confidential. Proprietary Information does not include any information that the receiving party can establish was (1) in the public domain, (2) already in the receiving party's possession or rightfully known prior to receipt, (3) rightfully learned from a third party not in violation of any other's proprietary rights, or (4) independently developed without access to Proprietary Information.
- 1.3 "Datalogic Product" means the Datalogic Powerscan® series, Powerscan® Imager series, Powerscan® EP series, Powerscan® LR series, Powerscan® HD series, and/or Powerscan RF® series scanner and/or scanner/ scale product, including all embedded Software in and all Documentation related to such product, which has been purchased or otherwise acquired by End User, whether obtained directly or indirectly from Datalogic.
- 1.4 "Software" means any software or computer programs of Datalogic or its third party licensors in machine readable form which is embedded in the Datalogic Product, whether obtained directly or indirectly from Datalogic, including any replacement, update, upgrade, enhancement or modification.

2. Scope Of License Granted.

- 2.1 Datalogic grants to End User a non-exclusive, non-transferable, perpetual license to use the Software, solely on the Datalogic Product in which it is embedded ("designated Datalogic Product"), in machine-readable form only, solely for End User's internal business purposes. This Agreement does not convey ownership of the Software to End User. Title to the Software shall be and remain with Datalogic or the third party from whom Datalogic has obtained a licensed right. As used in this Agreement, the term "purchase" or its equivalents when applied to the Software shall mean "acquire under license." End User is not entitled to receipt or use of the source code to any Software.

- 2.2 End User shall not copy, modify, decompile, disassemble, reverse engineer, or otherwise reproduce or manufacture the Software, whether modified or unmodified, nor sell, assign, sublicense, distribute, lend, rent, give, or otherwise transfer the Software to any other person or organization, for purposes other than as expressly provided in this Agreement, without Datalogic's prior written consent.

3. Transfers, Support.

- 3.1 Any copying, installing, reproduction, remanufacture, reverse engineering, electronic transfer, or other use of the Software on other than the designated Datalogic Product will be a material breach of this Agreement. However, Datalogic may elect not to terminate this Agreement or the granted licenses, but instead may elect to notify End User that End User is deemed to have ordered and accepted a license for each breaching use. End User shall pay Datalogic the applicable list price for such licenses as of the date of such breach.
- 3.2 End User shall not sell, assign, sublicense, distribute, lend, rent, give, or otherwise transfer the Datalogic Product to any third party unless such third party agrees with Datalogic in writing to be bound by the terms and conditions of this Agreement. Any such transfer of the Datalogic Product absent such agreement shall be null and void.
- 3.3 End User may obtain support for Software from Datalogic at Datalogic's standard support fees and under Datalogic's standard support terms and conditions in effect at the time the support is requested.

4. Intellectual Property.

End User acknowledges that the Software constitutes valuable trade secrets of Datalogic or Datalogic's third party licensors and that the Software is protected by intellectual property laws and treaties. The license set forth in this Agreement does not transfer to End User any ownership of Datalogic's or its third party licensors' copyrights, patents, trademarks, service marks, trade secrets, or other intellectual property rights and End User shall have no right to commence any legal actions to obtain such rights. End User shall not remove, modify, or take any other action that would obscure any copyright, trademark, patent marking, or other intellectual property notices contained in or on the Datalogic Product.

5. Proprietary Information.

- 5.1 End User acknowledges that Proprietary Information is the confidential, proprietary, and trade secret property of Datalogic and Datalogic's third party licensors and End User acquires no right or interest in any Proprietary Information.
- 5.2 End User shall not disclose, provide, or otherwise make available the Proprietary Information of Datalogic or its third party licensors to any person other than End User's authorized employees or agents who are under confidentiality agreement, and End User shall not use the Proprietary Information other than in conjunction with use of the Datalogic Product exclusively for End User's internal business purposes. End User shall take steps to protect the Proprietary Information no less securely than if it were End User's own intellectual property.
- 5.3 The provisions of this Proprietary Information Section shall survive and continue for five (5) years after the termination of this Agreement.

6. Limited Warranty.

- 6.1 Datalogic warrants that, under normal use and operation, the Datalogic Product will conform substantially to the applicable Documentation for the period specified in the Documentation. During this period, for all reproducible nonconformities for which Datalogic has been given written notice, Datalogic will use commercially reasonable efforts to remedy nonconformities verified by Datalogic. End User agrees to supply Datalogic with all reasonably requested information and assistance necessary to help Datalogic in remedying such nonconformities. For all defects reported to Datalogic within the warranty period, Datalogic's liability is limited to providing End User with one copy of corrections or responding to End User's problem reports according to Datalogic's standard assistance practices. Datalogic does not warrant that the product will meet End User's requirements or that use of the product will be uninterrupted or error free, or that Datalogic's remedial efforts will correct any nonconformance. This limited warranty does not cover any product that has been subjected to damage or abuse, whether intentionally, accidentally, or by neglect, or to unauthorized repair or unauthorized installation, and shall be void if End User modifies the product, uses the product in any manner other than as established in the Documentation, or if End User breaches any of the provisions of this Agreement.
- 6.2 EXCEPT AS PROVIDED IN THIS AGREEMENT, THE DATALOGIC PRODUCT IS PROVIDED "AS IS" AND DATALOGIC MAKES NO WARRANTIES OF ANY KIND, EXPRESS OR IMPLIED, WRITTEN OR ORAL, WITH RESPECT TO THE PRODUCT, AND SPECIFICALLY DISCLAIMS THE IMPLIED WARRANTIES OF MERCHANTABILITY AND FITNESS FOR A PARTICULAR PURPOSE.

7. Infringement.

- 7.1 Datalogic will defend End User against any claim in a lawsuit that the Datalogic Product furnished hereunder infringe a United States patent or copyright of a third party and Datalogic will pay any damages finally awarded against End User by a court of competent jurisdiction that are attributable to such claim or will pay End User's part of any settlement that is attributable to such claim, provided, that 1) End User notifies Datalogic promptly in writing of the claim, 2) Datalogic controls the defense or settlement of the claim, and 3) End User cooperates fully with Datalogic in such defense or settlement. All notices of a claim should be sent to Datalogic Scanning, Inc., Legal Department, 111 SW Fifth Ave. Suite 4100, Portland, OR 97204-3644.
- 7.2 In the defense or settlement of any such claim, Datalogic may, at its option, 1) procure for End User the right to continue using the Datalogic Product, 2) modify the Datalogic Product so that it becomes non-infringing, 3) replace the Datalogic Product with an equivalent product not subject to such claim, or 4) provide End User an opportunity to return the Datalogic Product and receive a refund of the purchase price paid, less a reasonable allowance for use.
- 7.3 Datalogic shall have no liability to End User for claims of infringement based upon 1) the use of any Datalogic Product in combination with any product which Datalogic has not either furnished or authorized for use with such Datalogic Product 2) the use of any Datalogic Product designed, manufactured, or modified to the specifications of End User, or 3) End User's modification of the Datalogic Product without written authorization from Datalogic.
- 7.4 THE FOREGOING STATES DATALOGIC'S COMPLETE AND ENTIRE OBLIGATION CONCERNING CLAIMS OF PATENT, COPYRIGHT, OR OTHER INTELLECTUAL PROPERTY INFRINGEMENT, CANCELS AND SUPERCEDES ANY PRIOR AGREEMENTS, WHETHER ORAL OR WRITTEN, BETWEEN THE PARTIES CONCERNING SUCH CLAIMS, AND WILL NOT BE MODIFIED OR AMENDED BY ANY PAST, CON-

TEMPORANEOUS, OR FUTURE AGREEMENTS OR DEALINGS BETWEEN THE PARTIES, WHETHER ORAL OR WRITTEN, EXCEPT AS SET FORTH IN A FUTURE WRITING SIGNED BY BOTH PARTIES.

8. Limitation Of Liability.

EXCEPT AS PROVIDED IN SECTION 7, DATALOGIC SHALL NOT BE LIABLE FOR ANY CLAIMS AGAINST END USER BY ANY OTHER PARTY. IN NO EVENT SHALL DATALOGIC'S LIABILITY FOR DAMAGES, IF ANY, WHETHER BASED UPON CONTRACT, TORT (INCLUDING NEGLIGENCE), PRODUCT LIABILITY, STRICT LIABILITY, WARRANTY, OR ANY OTHER BASIS, EXCEED THE PRICE OR FEE PAID BY END USER FOR THE DATALOGIC PRODUCT. UNDER NO CIRCUMSTANCES SHALL DATALOGIC BE LIABLE TO END USER OR ANY THIRD PARTY FOR LOST PROFITS, LOST DATA, INTERRUPTION OF BUSINESS OR SERVICE, OR FOR ANY OTHER SPECIAL, CONSEQUENTIAL, CONTINGENT, INDIRECT, INCIDENTAL, PUNITIVE, EXEMPLARY, OR OTHER SIMILAR DAMAGES, EVEN IF DATALOGIC HAS BEEN ADVISED OF THE POSSIBILITY OF SUCH DAMAGES.

9. Government Restricted Rights; International Use.

- 9.1 Use, duplication, or disclosure of the Software by the U.S. Government is subject to the restrictions for computer software developed at private expense as set forth in the U.S. Federal Acquisition Regulations at FAR 52.227-14(g), or 52.227-19 or in the Rights in Technical Data and Computer Software clause at DFARS 252.227-7013(c)(1)(ii), whichever is applicable.
- 9.2 If End User is using the Datalogic Product outside of the United States, End User must comply with the applicable local laws of the country in which the Datalogic Product is used, with U.S. export control laws, and with the English language version of this Agreement. The provisions of the "United Nations Convention on International Sale of Goods" shall not apply to this Agreement.

10. Termination.

- 10.1 Either party may terminate this Agreement or any license granted under this Agreement at any time upon written notice if the other party breaches any provision of this Agreement.
- 10.2 Upon termination of this Agreement, End User immediately shall cease using any non-embedded software and shall return to Datalogic or destroy all non-embedded software covered by this Agreement, and shall furnish Datalogic with a certificate of compliance with this provision signed by an officer or authorized representative of End User. For embedded software, End User agrees to sign a waiver prepared by Datalogic concerning further use of the embedded Software. End User's resumed or continued use of the embedded Software after termination shall constitute End User's agreement to be bound by the terms and conditions of this Agreement for such use.

11. General Provisions.

- 11.1 Entire Agreement; Amendment. This document contains the entire agreement between the parties relating to the licensing of the Software and supersedes all prior or contemporaneous agreements, written or oral, between the parties concerning the licensing of the Software. This Agreement may not be changed, amended, or modified except by written document signed by Datalogic.
- 11.2 Notice. All notices required or authorized under this Agreement shall be given in writing, and shall be effective when received, with evidence of receipt. Notices to Datalogic shall be sent to the attention of Contract Administration, Datalogic Scanning Inc., 959 Terry Street, Eugene, OR 97402, or such other address as may be specified by Datalogic in writing.
- 11.3 Waiver. A party's failure to enforce any of the terms and conditions of this Agreement shall not prevent the party's later enforcement of such terms and conditions.
- 11.4 Governing Law; Venue. This Agreement and the rights of the parties hereunder shall be governed by and construed in accordance with the laws of the State of Oregon U.S.A, without regard to the rules governing conflicts of law. The state or federal courts of the State of Oregon located in either Multnomah or Lane counties shall have exclusive jurisdiction over all matters regarding this Agreement, except that Datalogic shall have the right, at its absolute discretion, to initiate proceedings in the courts of any other state, country, or territory in which End User resides, or in which any of End User's assets are located.
- 11.5 Attorneys' Fees. In the event an action is brought to enforce the terms and conditions of this Agreement, the prevailing party shall be entitled to reasonable attorneys' fees, both at trial and on appeal.

- END -

Getting Started

Installing the Battery Pack



NOTE

To charge the Battery Pack, See “Battery Pack Charging and Maintenance” on page 11.

Datalogic recommends annual replacement of rechargeable battery packs to ensure maximum performance.



WARNING

Do not discharge the battery using any device except for the reader. When the battery is used in devices other than the linear imager, it may damage the battery or reduce its life expectancy. If the device causes an abnormal current to flow, it may cause the battery to become hot, explode or ignite and cause serious injury.

Lithium-ion battery packs may get hot, explode or ignite and cause serious injury if exposed to abusive conditions. Be sure to follow the safety warnings listed below:

- Do not place the battery pack in fire or heat.
- Do not connect the positive terminal and negative terminal of the battery pack to each other with any metal object (such as wire).
- Do not carry or store the battery pack together with metal objects.
- Do not pierce the battery pack with nails, strike it with a hammer, step on it or otherwise subject it to strong impacts or shocks.
- Do not solder directly onto the battery pack.
- Do not expose the battery pack to liquids, or allow the battery to get wet.

In the event the battery pack leaks and the fluid gets into your eye, do not rub the eye. Rinse well with water and immediately seek medical care. If left untreated, the battery fluid could cause damage to the eye.



CAUTION

Always charge the battery at 32° – 113°F (0° - 45°C) temperature range.

Use only the authorized power supplies, battery pack, chargers, and docks supplied by your Datalogic reseller. The use of any other power supplies can damage the linear imager and void your warranty.

Do not disassemble or modify the battery. The battery contains safety and protection devices, which, if damaged, may cause the battery to generate heat, explode or ignite.

Do not place the battery in or near fire, on stoves or other high temperature locations.

Do not place the battery in direct sunlight, or use or store the battery inside cars in hot weather. Doing so may cause the battery to generate heat, explode or ignite. Using the battery in this manner may also result in a loss of performance and a shortened life expectancy.

Do not place the battery in microwave ovens, high-pressure containers or on induction cookware.

Immediately discontinue use of the battery if, while using, charging or storing the battery, the battery emits an unusual smell, feels hot, changes color or shape, or appears abnormal in any other way.

Orient the Battery Pack as shown in [Figure 1-1](#), then push it into the reader until the alignment pins engage and the unit snaps into place. To remove the Battery Pack, push in on the release latches on either side of its base and pull it straight out of the reader.

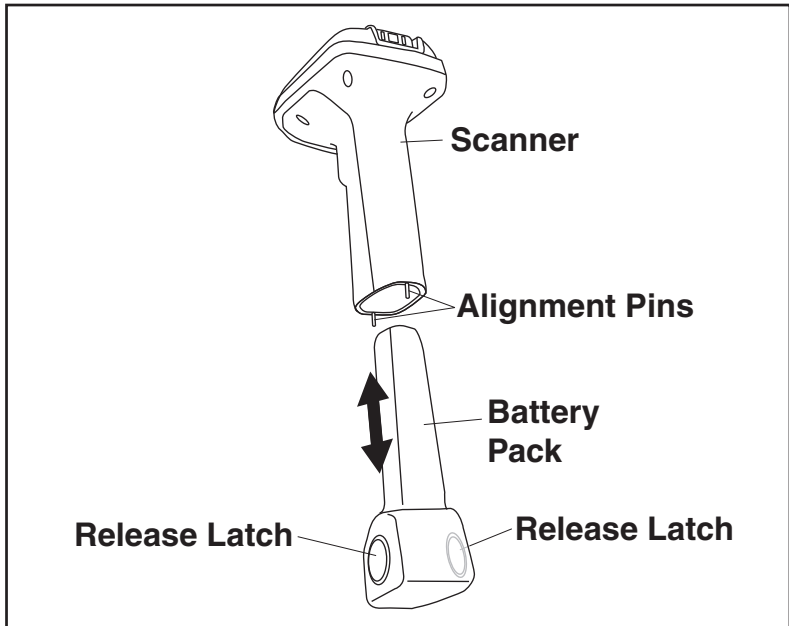
Figure 1-1. Battery Pack Installation & Removal

Verifying Reader Operation Before Linking

Once a charged Battery Pack has been installed in the reader, scan a good sample barcode of the symbology¹ type your reader is programmed to read. If unsure how to do this, see the section on **How to Scan** in this manual. Tip: The part number barcode on the back cover of this manual is a Code 39 symbology sample.

The system may signal with one or a combination of indicators depending upon the "connection" status of the reader (see LED and Beeper Indications for details). If your reader fails to read a sample barcode of a symbology it is programmed to read, turn to the section titled, **Troubleshooting**.

1. To enable more barcode symbology types, reference the Product Reference Guide (PRG).

Figure 1-2. Labeling and Nomenclature

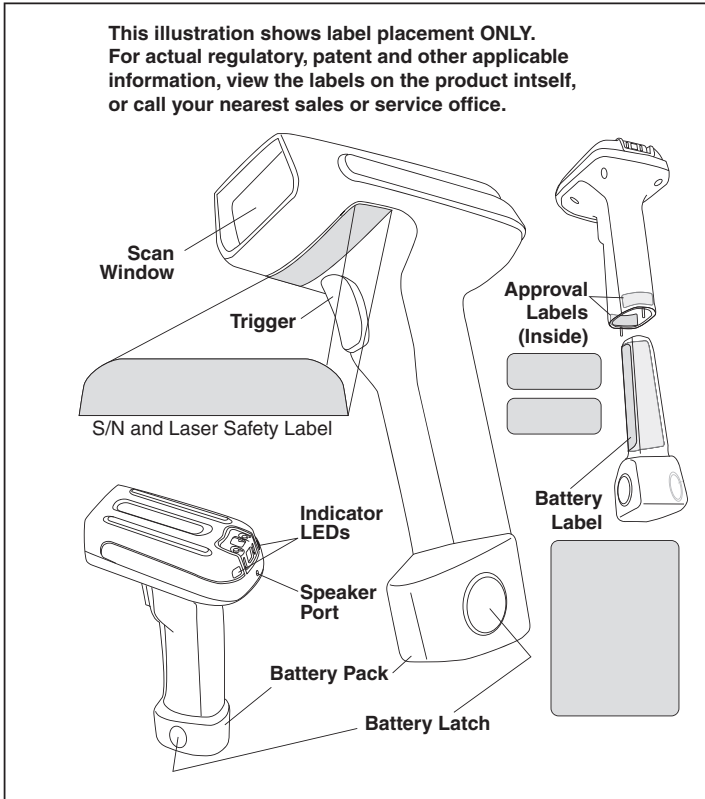

NOTE

PowerScan® PBT7100 readers and Base Stations can be configured to be compatible with PowerScan® 7000BT imagers and Base Stations. Consult the Product Reference Guide (PRG) for full details.

Linking the Reader to a Base Station



NOTE

To link the reader to its own Base Station, refer to the instructions provided in the Base Station Quick Reference Guide (QRG).

Linking the Reader to a **Bluetooth**® Enabled Device

A reader can optionally be linked to a PC with a **Bluetooth** radio installed.

1. Ensure that the **Bluetooth** enabled device and its driver are installed on the PC.
2. On the PC, open the control window for the **Bluetooth** device (usually called “My **Bluetooth** Places”). Security settings are supported for the **Bluetooth** serial port.
3. Scan the “Link to a PC” barcode below.



Link to a PC

4. On the PC, search for **Bluetooth** enabled devices that are in range and select the “Datalogic PS7100 Reader.”
5. Connect with the serial port for the Datalogic PS7100 reader. Note which serial port number is assigned to the reader.
6. Open your serial port application and connect to the reader using the serial port that was assigned in the previous step.

Battery Pack Charging and Maintenance



NOTE

The Amber LED will blink twice when a barcode is decoded when the battery is getting low.

Seat the reader (with installed Battery Pack) in a powered Base Station as shown in **Figure 1-3**, ensuring the Battery Pack is fully seated and engages the station’s metal contacts. The reader will sound a short “chirp” when good contact is made and the green LED on the Base Station should flash, indicating the battery is charging. Alternatively, multiple Battery Packs can be charged external to the reader using an accessory charging unit available from your Datalogic dealer.

There presently are no US, North America or World disposal requirements for Lithium-Ion batteries such as the Battery Pack, so when they won't hold a charge anymore they can be disposed of; preferably through a recycling center. Contact your local government for disposal or recycling practices in your area.

Figure 1-3. Charging the Battery Pack in a Docked Reader

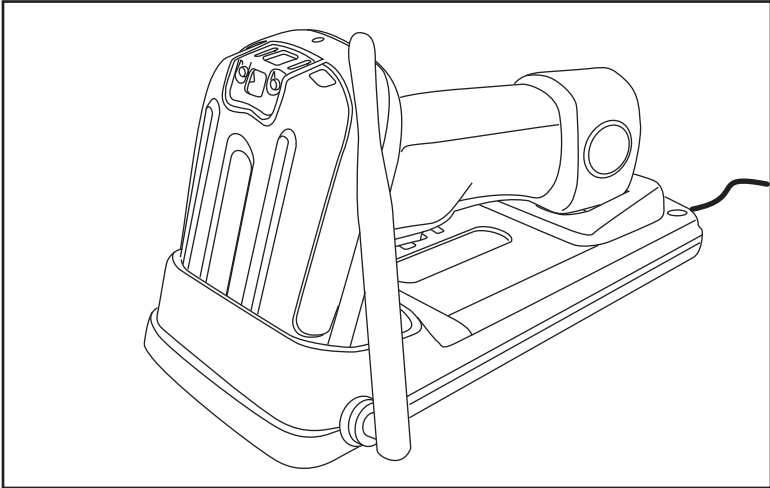

Programming

The reader is typically factory-configured with a set of default features. You can select other options and customize your reader through use of the instructions and programming barcodes available in the Product Reference Guide (PRG). You can view and download this and other manuals from the website listed on the back cover of this manual.

Resetting the Standard Product Defaults

If programming settings for your reader are in an unknown condition, factory settings can be restored by scanning the “Standard Product Default Settings” barcode below. A listing of factory default settings is available in the PRG. Settings can vary, depending upon the interface type.

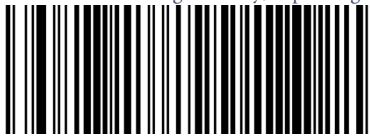

Standard Product Default Settings

Defaults

For your convenience, standard factory defaults¹ are shown here for each of the major interface types. For more details or to change these settings, reference the Product Reference Guide (PRG).

RS-232 Standard Default Settings:9600 Baud, no Parity, 1 Stop Bit, Handshaking disabled, no Intercharacter Delay, Beep on ASCII BEL disabled, Beep On Not On File enabled, ACK Character = 'ACK', NAK Character = 'NAK', ACK NAK Timeout Value = 600ms, ACK NAK Retry Count = 3, ACK NAK Error Handling = Ignore, Indicate Transmission Failure enabled, Disable Reader Command = 'D', Enable Reader Command = 'E'.

Wand Emulation Standard Default Settings:Wand Idle State = Low, Wand Polarity = Quiet Zones & Spaces High - Bars Low, No Label Symbology Conversion, Transmit Noise = Disabled.

OEM/IBM Standard Default Settings:OEM-USB Device Usage = Table Top Reader, Transmit Labels in Code 39 Format = OEM Standard Format, 46xx Number of Host Resets = 6.

USB Standard Default Settings:USB Keyboard Speed = Fast (1ms).

Keyboard Standard Default Settings (Keyboard AT):Country Mode = U.S., Caps Lock= OFF, Numlock Key =Unchanged, Send Control Characters = Disabled, Wedge Quiet Interval = 100ms, No Wedge Intercode Delay.

Enabled Symbologies

- UPC-A, UPC-E, EAN 13, EAN 8 — without add-ons, Check Character Transmission enabled, no Expansion, Minimum Reads = 1 (except In-Store Minimum Reads = 2), System Number Transmission = enabled, 2D Components = disabled, EAN 8 Guard Insertion/Substitution Options = disabled (except EAN 8 Guard Substitution), Stitching = disabled.
- Code 39 — Check Character Calculation/Transmission enabled, Start/Stop Character disabled, Full ASCII disabled, Quiet Zones = auto, Minimum Reads = 1, Decoding Level and Aggressiveness = 3, Variable Length Control, Length One = 2, Length Two = 50, Interdigit Ratio = 4, Character Correlation = Disabled, Stitching is enabled.
- Code 128 — No Expansion, Check Character Transmission enabled, SubCode Change not transmitted, Quiet Zones = Auto, Minimum Reads = 1, Decoding Levels and Aggressiveness = 3, Variable Length Control, Length One = 1, Length two = 80, Character Correlation = disabled, Stitching = enabled.
- Interleaved 2 of 5 — Zero Pattern and Check Character Calculation = disabled, Check Character Transmission = enabled, Minimum Reads = 1, Decoding Levels and Aggressiveness = 3, Variable Length Control, Length One = 12, Length Two = 100, Character Correlation and Stitching = disabled.

1. Applicable only when the reader is connected to a host via the Base Station.

How to Scan

When the trigger is pressed, a red laser aiming beam is activated, enabling the user to align its horizontal and vertical position with the desired barcode. The aiming beam will remain on until a configurable time-out¹ period elapses, then the red scan LEDs are activated to read the barcode.

If the barcode is not decoded before another configurable period has expired, the laser aiming beam will begin blinking to allow the user to continue pointing the reader at the desired barcode.



NOTE

If the surface being scanned is highly reflective (e.g., laminated), it may be necessary to tilt the item or the reader slightly (15° to 18°) to prevent unwanted reflection.

Barcodes : To scan, center the illumination beam over the barcode as shown in **Figure 1-4**. The reader must “see” across the width of all of the bars. Move the reader further away from the barcode to increase the scanning coverage area, and closer in to read very small barcodes.

Figure 1-4. Scanning Barcodes

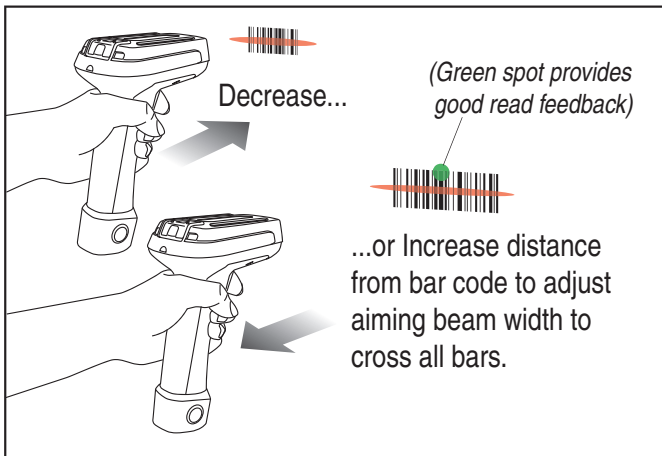

Troubleshooting

Troubleshoot your scanning system by performing the following checks:

Troubleshooting the BT System

For the BT system, ensure...

-
1. Reference the Product Reference Guide (PRG) for more information about the aiming beam time-out period. (Default for the time-out is 100mS.)

- the battery is charged. See **Battery Pack Charging and Maintenance on page 11**.
- the battery is properly installed. See **Installing the Battery Pack on page 7**.
- the reader is linked to the desired Base Station. See the Quick Reference Guide (QRG) for the Base Station.
- the reader is within reasonable operating range of the Base Station, with no major obstructions between the radio units such as thick walls or heavy machinery. (At the time of this writing, maximum reader-to-Base Station range is specified at 100 meters.) Your range may vary depending on the environment the system is being used in.
- the Base Station is powered-on. When the Base Station powers up, both LEDs briefly flash. If both lights are bright and crisp, this is a good indication of adequate power input from the AC Adapter.
- the Base Station interface cable is securely attached to the host. Consult your technical support manager or refer to your host system manual to identify the proper cable connection for the reader. If necessary, verify interface cable function by using a known-good interface cable.

Troubleshooting the Reader

If the problem is specific to scanning, verify that...

- The reader will automatically perform a set of self-tests whenever you turn it on. Observe and note any special indications made by the reader (an unexpected pattern of flashes or beeps) during power-up. If technical support is contacted regarding a problem, they may request this information.
- Does the reader power on? Does the illumination beam come on?
If no illumination beam, check that...
 - the battery has been adequately charged.
 - the battery is fully seated and its latch engaged.
 - the trigger works.
- Is the reader having trouble reading your symbols?
If the reader isn't reading symbols well, check that the symbols...
 - aren't smeared, rough, scratched, or exhibiting voids.
 - aren't coated with frost or water droplets on the surface.
 - are enabled in the reader. See the Product Reference Guide (PRG) for more about configuring the reader to read symbologies).
- Is the barcode displayed but not entered?
The barcode is displayed on the host device correctly, but you still have to press a key to enter it (the Enter/Return or Tab key, for example).
You need to program a suffix which enables the reader to output the barcode data plus the key you need (such as a carriage return "CR") to enter the data into your application. Refer to the PRG for further information.
- Does the reader read the barcode incorrectly?
If the reader reads a barcode, but the data is not displayed correctly on the host screen:
 - The reader may not be programmed for the appropriate terminal interface. For example, you scan "12345" and the host displays "@es%." Reprogram the reader with the correct interface selection barcode. See the Product Reference Guide (PRG).

-
- The reader may not be programmed to output your barcode data properly. For example, you scan “12345” and the host displays “A12345B.” Reprogram the reader with the proper Data Editing selections. Reference the PRG.
 - The reader won’t read your barcode at all.
 - Scan the part number barcode on the back of this manual or other known-good barcode samples. If the reader reads sample barcodes, check that your target barcode is readable.
 - Verify that your barcode symbology is enabled. See the PRG.
 - If you aren’t sure what programming options have been set in the reader, or if you want the factory default settings restored, go to the [Resetting the Standard Product Defaults](#) section of this manual and scan the standard factory default settings barcode.
 - The reader sounds other than a standard “Good Read” beep followed by an “Acknowledge¹” beep when reading a barcode (indicating the barcode has been read and properly transmitted).
 - Verify the reader is linked to and within range of its Base Station.

1. Typically, both of these beep indications are active in the reader. To enable/disable these indications, reference the PRG.

EUROPEAN DECLARATION OF CONFORMITY



Datalogic Scanning, Inc. hereby declares that the apparatus specified below has been tested and found compliant to the following European Council Directives and Harmonized Standards:

Apparatus: PowerScan PBT7100 System

Directives: EMC 2004/108/EC
Low Voltage 2006/95/EC
R&TTE 1999/5/EC
RoHS 2002/95/EC
WEEE 2002/96/EC

Standards: EN 301 489-1 v 1.6.1 reference
EN 301 489-17 v 1.2.1:2002
EN 300 328 v 1.7.1: 2006
EN 50392:2004
EN 61000 6-2:2005

IEC 60950-1:2007
EN 60825-1: 2007
EN 61000-3-2: 2000
EN 61000-3-3:1995+A1:2001
UL 1642, UL 2054, UN 38.3

Radio Immunity
Radio Emissions
Human exposure to electromagnetic fields
Generic Immunity - for Industrial Environments.
Includes EN61000-4-2 (ESD), 4-3 (Radiated immunity), 4-4 (EFT), 4-5 (Surge), 4-6 (Cond Immunity) and 4-11 (voltage dips/interruptions)
ITE Safety
Laser Safety
Harmonic Current
Voltage Fluctuation/Flicker
Safety - Li-ion Battery Pack

Equipment Type: Handheld Barcode Scanning Equipment

Interface Protocol: RS-232, USB, Keyboard Wedge, IBM

Placed into EU Service: January 2009 under the Datalogic logo

Responsible Manufacturer: Datalogic Scanning, Inc. 959 Terry St. Eugene, Oregon 97402 USA

A handwritten signature in black ink that reads "Brad West".

Brad West
Dec. 16, 2008
Vice President
Supply Chain Operations
Datalogic Scanning, Inc.



Australia

Datalogic Scanning Pty Ltd
Telephone: [61] (2) 9870 3200
australia.scanning@datalogic.com

France and Benelux

Datalogic Scanning SAS
Telephone: [33].01.64.86.71.00
france.scanning@datalogic.com

Germany

Datalogic Scanning GmbH
Telephone: 49 (0) 61 51/93 58-0
germany.scanning@datalogic.com

India

Datalogic Scanning India
Telephone: 91- 22 - 64504739
india.scanning@datalogic.com

Italy

Datalogic Scanning SpA
Telephone: [39] (0) 39/62903.1
italy.scanning@datalogic.com

Japan

Datalogic Scanning KK
Telephone: 81 (0)3 3491 6761
japan.scanning@datalogic.com

Latin America

Datalogic Scanning, Inc
Telephone: (305) 591-3222
latinamerica.scanning@datalogic.com

Singapore

Datalogic Scanning Singapore PTE LTD
Telephone: (65) 6435-1311
singapore.scanning@datalogic.com

Iberia

Datalogic Scanning SAS Sucursal en España
Telephone: 34 91 746 28 60
spain.scanning@datalogic.com

United Kingdom

Datalogic Scanning LTD
Telephone: 44 (0) 1582 464900
uk.scanning@datalogic.com



www.scanning.datalogic.com

Datalogic Scanning, Inc.

959 Terry Street
Eugene, OR 97402
USA
Telephone: (541) 683-5700
Fax: (541) 345-7140

