

Thor™ VX8

Vehicle-Mount Computer

Microsoft® Windows® Embedded Standard Operating System

Microsoft® Windows® 7 Professional Operating System

Microsoft® Windows® XP® Professional Operating System

Reference Guide

Disclaimer

Honeywell International Inc. ("HII") reserves the right to make changes in specifications and other information contained in this document without prior notice, and the reader should in all cases consult HII to determine whether any such changes have been made. The information in this publication does not represent a commitment on the part of HII.

HII shall not be liable for technical or editorial errors or omissions contained herein; nor for incidental or consequential damages resulting from the furnishing, performance, or use of this material.

This document contains proprietary information that is protected by copyright. All rights are reserved. No part of this document may be photocopied, reproduced, or translated into another language without the prior written consent of HII.

© 2009-2012 Honeywell International Inc. All rights reserved.

Web Address: www.honeywellaidc.com

RFTerm is a trademark or registered trademark of EMS Technologies, Inc. in the United States and/or other countries.

Microsoft® Windows, ActiveSync®, MSN, Outlook®, Windows Mobile®, the Windows logo, and Windows Media are registered trademarks or trademarks of Microsoft Corporation.

Intel®, Atom™, Core™, Celeron® and Pentium® are trademarks or registered trademarks of Intel Corporation or its subsidiaries in the United States and other countries.

Summit Data Communications, the Laird Technologies Logo, the Summit logo, and "Connected. No Matter What" are trademarks of Laird Technologies, Inc.

Atheros® and the Atheros logo are registered trademarks of Atheros Communications, Inc.

Broadcom® and the Broadcom logo are registered trademarks of Broadcom Corporation.

The Bluetooth® word mark and logos are owned by the Bluetooth SIG, Inc.

Symbol® is a registered trademark of Symbol Technologies. MOTOROLA, MOTO, MOTOROLA SOLUTIONS and the Stylized M Logo are trademarks or registered trademarks of Motorola Trademark Holdings, LLC and are used under license.

RAM® and RAM Mount™ are both trademarks of National Products Inc., 1205 S. Orr Street, Seattle, WA 98108.

Freefloat, Freefloat Wling and Freefloat Access*One are trademarks of Freefloat, Mölndalsvägen 30B, SE-412 63Gothenburg, Sweden.

OneClick Internet is WebToGo's patented connection manager customized for Honeywell mobile devices. OneClick Internet documentation is copyright 2010 by WebToGo and modified by Honeywell with WebToGo's express permission.

Verizon® is a registered trademark of Verizon Trademark Services LLC.

T-MOBILE® is a registered trademark of Deutsche Telekom AG.

AT&T® is a registered trademark of AT&T Intellectual Property.

Option® and GlobeTrotter® are registered trademarks of Option NV.

Acrobat® Reader © 2012 with express permission from Adobe Systems Incorporated.

Other product names or marks mentioned in this document may be trademarks or registered trademarks of other companies and are the property of their respective owners.

Patents

For patent information, please refer to www.honeywellaidc.com/patents.

Limited Warranty

Refer to www.honeywellaidc.com/warranty_information for your product's warranty information.

Table of Contents

Chapter 1: Introduction	1-1
Overview	1-1
Microsoft Windows License Agreement (First Boot)	1-1
Quick Start	1-2
Components	1-3
Under Service Lid	1-3
Connector Panel	1-4
Buttons and LEDs	1-5
LED Indications	1-6
Power LED	1-6
UPS Mode LED	1-6
Hard Drive LED	1-6
Data Entry	1-7
Keyboard Data Entry	1-7
Bar Code Data Entry	1-7
Touch Screen Entry	1-7
Soft Keyboard Entry	1-8
Chapter 2: Hardware	2-1
Hardware Configuration	2-1
Power Input	2-1
Uninterruptible Power Supply	2-1
Backup Battery	2-1
PCMCIA Slot	2-1
Power Management	2-1
Physical Controls	2-2
Power Button	2-2
Display Brightness Buttons	2-3
External Connectors	2-4
Serial Connector – COM1	2-5
Pinout	2-5
Serial Connector – COM2	2-6
Pinout	2-6
PS/2 Keyboard Connector	2-7
Pinout	2-7
PS/2 Mouse Connector	2-8
Pinout	2-8
RJ45 Connector	2-9

Pinout	2-9
Multipurpose Connector	2-10
Pinout	2-10
Multipurpose Dongle Cables	2-11
D15 Female Connector	2-12
Pinout	2-12
USB Connector	2-13
Pinout	2-13
Serial Connector - COM4	2-14
Pinout	2-14
Audio and Microphone Connectors	2-15
Antenna Connectors	2-15
Power Supply Connector	2-16
Pinout	2-16
Keyboards	2-17
95-key Keyboard	2-17
60-key Keyboard	2-18
95-key QWERTY Keyboard with Pointing Device	2-19
Key Maps	2-19
NumLock	2-19
CapsLock and Scroll Lock	2-19
Keyboard Backlight	2-20
60-key QWERTY Keyboard	2-21
Key Maps	2-21
Unused Key Functions	2-21
NumLock	2-21
Keyboard Backlight	2-22
Control Keys	2-22
Keyboard LEDs	2-23
CAPS LED	2-23
Secondary Keys LED	2-24
IBM 3270 Keypad Overlay	2-25
IBM 5250 Keypad Overlay	2-25
General Windows Keyboard Shortcuts	2-26
PS/2 Keyboard/Mouse	2-27
Virtual Keyboard	2-27
Display	2-29
Cleaning the Display	2-29
Touch Screen	2-29
PCMCIA Slot (Optional)	2-30

Install PCMCIA Cards.....	2-30
PCMCIA Pinout.....	2-31
Power Supply.....	2-32
Vehicle DC Connection.....	2-33
Screen Blanking.....	2-35
Uninterruptible Power Supply Battery Pack.....	2-36
External Power Supply.....	2-36
CMOS Battery.....	2-36
Hardware Problems.....	2-37
Power Source.....	2-37
Keyboard.....	1-7
Display / Touch Screen.....	2-38
Hard Disk Drive.....	2-38
Memory Conflicts.....	2-38
Optional Devices.....	2-39
Chapter 3: Software.....	3-1
Introduction.....	3-1
Operating System.....	3-1
BIOS Setup.....	3-2
Accessing the BIOS Setup.....	3-3
AMI BIOS.....	3-3
Phoenix BIOS.....	3-3
Identifying Drives in the Thor VX8.....	3-3
AMI BIOS.....	3-3
Phoenix BIOS.....	3-3
Integrated Devices.....	3-4
AMI BIOS.....	3-4
Phoenix BIOS.....	3-4
Boot Priority.....	3-5
AMI BIOS.....	3-5
Phoenix BIOS.....	3-5
PXE - Pre Boot Execution.....	3-5
AMI BIOS.....	3-5
Phoenix BIOS.....	3-5
Exit BIOS Configuration.....	3-6
AMI BIOS.....	3-6
Phoenix BIOS.....	3-6
VMT Keyboard Backlighting.....	3-7
Microsoft Windows Setup and Configuration.....	3-8

Microsoft Windows License Agreement (First Boot).....	3-8
Drive C Directory Structure.....	3-8
Software Loaded on Drive C.....	3-9
Thor VX8 Configuration Options.....	3-10
Date and Time.....	3-10
Power Management.....	3-10
Speaker Volume.....	3-10
Connect Bluetooth Devices.....	3-10
Restart/Shutdown.....	3-11
Soft Keyboard.....	3-11
Calibrate Touch Screen.....	3-11
Touch Screen.....	3-12
Calibrating the Touch Screen.....	3-12
Disabling the Touch Screen.....	3-12
Network Configuration.....	3-12
802.11 Wireless Radios.....	3-12
Ethernet Connector.....	3-12
WWAN.....	3-12
Bluetooth.....	3-12
VMT Manager.....	3-13
Main Tab.....	3-13
General Settings Tab.....	3-14
UPS Tab.....	3-16
Display Backlight Tab.....	3-17
Advanced Tab.....	3-19
Wedge.....	3-20
Configuration.....	3-20
Loading an Operating System on the Thor VX8.....	3-22
The Thor VX8 Recovery DVD.....	3-23
DVD Part numbers.....	3-23
Thor VX8 Recovery DVD.....	3-23
Launching the RS2 Wizard.....	3-23
Using the RS2 Wizard.....	3-24
The Thor VX8 Drivers CD-ROM.....	3-25
Startup Problems.....	3-26
Bypassing Microsoft Windows Startup.....	3-26
Verifying Boot Order.....	3-26
Setting System Time and Date.....	3-27

Chapter 4: Wireless Network Configuration **4-1**

Introduction	4-1
Summit Wireless Network Configuration	4-2
Important Notes	4-2
Summit Client Utility	4-3
Help	4-3
Summit Tray Icon	4-4
Wireless Zero Config Utility	4-5
How To: Use the Wireless Zero Config Utility	4-5
How to: Switch Control to SCU	4-5
Main Tab	4-6
Admin Login	4-7
Profile Tab	4-8
Buttons	4-9
Profile Parameters	4-10
Status Tab	4-12
Diags Tab	4-13
Global Tab	4-14
Custom Parameter Option	4-15
Global Parameters	4-16
Logon Options	4-20
Single Signon	4-21
Pre-Logon Connection	4-21
Sign-On vs. Stored Credentials	4-22
How to: Use Stored Credentials	4-22
How to: Use Sign On Screen	4-23
How to: Use Windows Username and Password	4-23
Windows Certificate Store vs. Certs Path	4-24
User Certificates	4-24
Root CA Certificates	4-24
How To: Use the Certs Path	4-24
How To: Use Windows Certificate Store	4-24
Configuring the Profile	4-26
No Security	4-27
WEP	4-28
LEAP	4-30
PEAP/MSCHAP	4-32
PEAP/GTC	4-35
WPA/LEAP	4-38
EAP-FAST	4-40
EAP-TLS	4-42

WPA PSK	4-45
Certificates.....	4-46
Generating a Root CA Certificate.....	4-47
Installing a Root CA Certificate.....	4-51
Generating a User Certificate.....	4-53
Exporting a User Certificate.....	4-56
Installing a User Certificate.....	4-58
Atheros Client Utility - 802.11a/b/g Radio.....	4-60
Wireless Zero Config.....	4-60
Using the ACU.....	4-61
No Security.....	4-62
WEP.....	4-63
LEAP.....	4-65
WPA-PSK.....	4-67
PEAP/MS-CHAP.....	4-68
PEAP-GTC.....	4-70
EAP-TLS.....	4-72
WPA LEAP.....	4-74
EAP-FAST.....	4-76
Broadcom Wireless Utility - 802.11b/g Radio.....	4-79
Wireless Zero Config.....	4-79
Using the BWU.....	4-79
No Security.....	4-80
WEP.....	4-81
LEAP.....	4-82
WPA-PSK.....	4-83
PEAP/MS-CHAP.....	4-84
PEAP-GTC.....	4-85
EAP-TLS.....	4-86
WPA LEAP.....	4-88
EAP-FAST.....	4-89
Certificates.....	4-90
Bluetooth.....	4-92
8650 Bluetooth Ring Scanner/Imager.....	4-92
Devices Tab.....	4-92
Options Tab.....	4-94
COM Ports Tab.....	4-95
Hardware Tab.....	4-96
SIM card installation.....	4-97
Requirements.....	4-97

Installation.....	4-97
Option GlobeTrotter Connect.....	4-99
SIM Card PIN.....	4-99
Using Option GlobeTrotter Connect.....	4-99
OneClick Internet.....	4-101
Preparing for Initial Use on the Thor VX8.....	4-101
Install SIM Card.....	4-101
Load Firmware.....	4-101
Activation.....	4-101
Using OneClick Internet.....	4-104
Connection Management.....	4-104
Menu Buttons.....	4-105
Radio Button.....	4-105
Statistics Button.....	4-105
Update Button.....	4-105
Help Button.....	4-105
Settings Button.....	4-106
Profile Tab.....	4-107
Buttons.....	4-108
Parameters.....	4-108
Network Tab.....	4-109
Network with SIM Card.....	4-109
CDMA Network.....	4-111
History Tab.....	4-112
PIN Tab.....	4-112
Activate/Deactivate PIN.....	4-112
Change PIN.....	4-113
Info Tab.....	4-114
Firmware Tab.....	4-115
Activation on CDMA.....	4-116
General Tab.....	4-117
Application Tab.....	4-118
Application Buttons.....	4-119
SMS.....	4-119
Web Browser.....	4-119
Email.....	4-119
GPS.....	4-119
About.....	4-120
System Requirements.....	4-120
Supported Languages.....	4-120

Installing or Upgrading OneClick Internet.....	4-120
Installation.....	4-121
OneClick Internet Connection Manager.....	4-124
Connection Management.....	4-124
Information Buttons.....	4-125
Chapter 5: Key Maps.....	5-1
95-key Keypad with Pointing Device.....	5-1
Key Map 101-Key Equivalencies.....	5-1
60-key Standard Keypad.....	5-2
60 Key KeyMap 101-Key Equivalencies.....	5-2
IBM Terminal Emulation.....	5-7
IBM 3270 Keypad Overlay.....	5-7
IBM 5250 Keypad Overlay.....	5-8
Chapter 6: Technical Specifications.....	6-1
Physical Specifications.....	6-1
Environmental Specifications.....	6-2
Display Specifications.....	6-2
Operating System.....	6-2
Radio Options.....	6-3
Chapter 7: Technical Assistance.....	7-1

Chapter 1: Introduction

Overview

The Thor VX8 Vehicle-Mount Computer (VMT) is a rugged, vehicle-mounted, PC (Personal Computer) equipped with a Microsoft® Windows® operating system. The Thor VX8 is capable of wireless data communications from a fork-lift truck or any properly configured vehicle. The unit uses a PCMCIA radio (spread spectrum 2.4GHz) for wireless data communications.

The Thor VX8 is a tablet-style computer and features a color display. The touch-screen display supports graphic features and Microsoft Windows icons that the Windows operating system supports. An illuminated keyboard is available to facilitate use in dimly lit areas.

The Thor VX8 provides the power and functionality of a desktop computer in a vehicle-mounted unit, with a [wide range of options](#).



For details on available RAM Mount™ options see the *Thor VX8 Vehicle Mounting Reference Guide*.

The Thor VX8 is available with the following operating systems:

- Windows® 7 Professional
- Windows® XP Professional
- Windows® Embedded Standard
- Windows® XP Embedded

The Thor VX8 can support only one operating system at a time. Information in this guide includes instruction for all operating systems. Differences are highlighted as follows:

- Windows® 7 Professional
- Windows® Embedded Standard
- Windows® XP Embedded
- Windows® XP Professional

Microsoft Windows License Agreement (First Boot)



If your Thor VX8 is shipped with a Microsoft Windows operating system pre-installed, it may be necessary to complete the Windows licensing/registration screens when starting the Thor VX8 for the first time. To complete this information, you may need the Microsoft Windows software/product key that was included with the Thor VX8.

Please refer to [Microsoft Windows License Agreement \(First Boot\)](#) for instruction.

Quick Start

This section's instructions are based on the assumption that your new system is pre-configured and requires only accessory installation (e.g. antenna, external keyboard and/or bar code scanner) and a power source.

In general, the sequence of events to prepare the Thor VX8 for use is:

1. Install Vehicle Mounting Bracket (and keyboard mounting bracket) on vehicle.
2. Secure Thor VX8 in Mounting Bracket Assembly.
3. Connect power cable to the Thor VX8. Route the power cable to a DC/DC converter then to the vehicle battery.
4. An optional screen blanking box may also be connected to the Thor VX8.
5. Connect accessories to Thor VX8, e.g. scanner, keyboard.
6. Secure all cables to the Thor VX8 with the Strain Relief Cable Clamps.
7. Turn the Thor VX8 on.

The Thor VX8 and its keyboard should be mounted in an area in the vehicle where it:

- Does not obstruct the vehicle driver's vision or safe vehicle operation.
- Can be easily accessed by anyone seated in the driver's seat.

Components

Under Service Lid

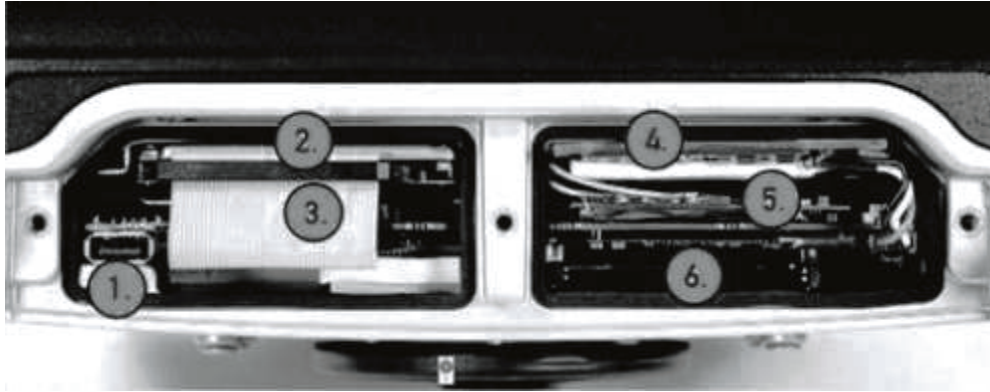

The service lid has been removed to show components.

Position	Function
1	USB 2.0
2	Hard drive
3	CompactFlash slot, optional (behind HD cable)
4	Battery/UPS
5	Mini PCI slot
6	PC Card slot (option)

Connector Panel

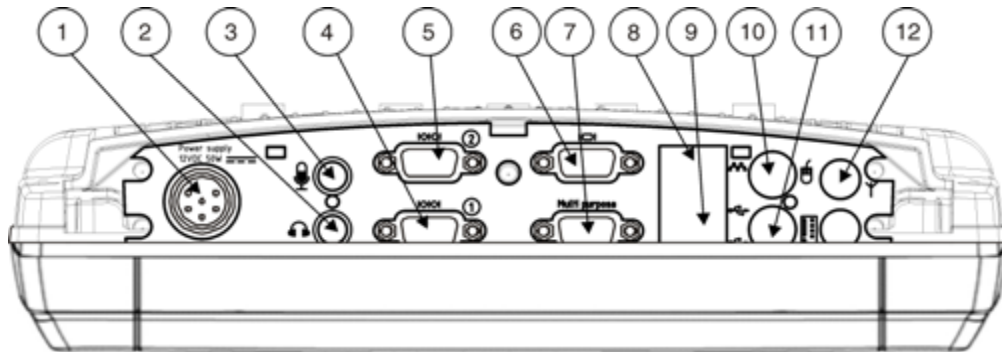

Position	Function
1	Power Supply Connector (12V DC 50W)
2	Mic. in
3	Audio out
4	COM1 Connector
5	COM2 Connector
6	VGA (external monitor) Connector
7	Multipurpose Connector (provides USB, COM4 or both with optional cable)
8	RJ-45 Ethernet 10/100 Connector
9	2x USB 2.0 Ports
10	PS/2 Mouse port
11	PS/2 Keyboard Port
12	Bluetooth Antenna Connector

Buttons and LEDs

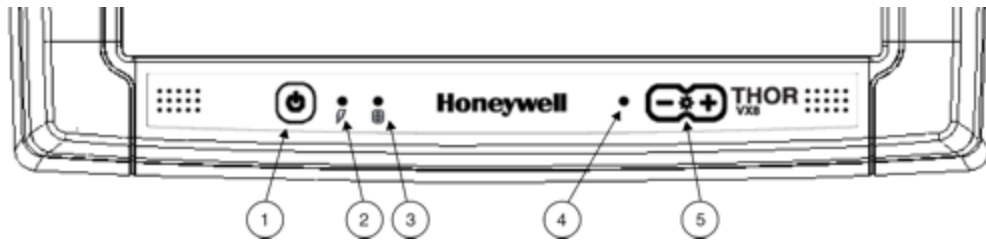

Position	Function
1	Power Button (includes Power LED)
2	UPS Mode LED
3	Hard Drive LED
4	Light Sensor
5	Screen Brightness Adjustment Buttons

LED Indications

Power LED

The Power LED is incorporated into the power button.

Function	Power LED
Off and not powered	Off (no light)
Off but powered	Green flash very slow
Operating normally	Green on
Suspend	Green flashing slow
Black-out Screen	Green flashing fast
Over voltage shutdown	Red on
Over temperature	Red flashing

UPS Mode LED

The UPS Mode LED is located to the right of the power button.

Function	UPS Mode LED
UPS battery powered	Green flashing fast
UPS battery charging	Green on or flashing slow
UPS battery charged	Off (no light)

Hard Drive LED

The Hard Drive LED is located to the right of the UPS Mode LED.

Function	Hard Drive LED
Hard drive activity	Green flashing
No activity	Off (dark)

Data Entry

You can enter data into the Thor VX8 through several different methods. A tethered scanner connected to the COM1 serial port or a Bluetooth scanner provides bar code data entry, the serial ports are used to input/output data, keyboards provide manual entry and the touch screen also provides manual entry (simulating a desktop PC's mouse).

Keyboard Data Entry

Refer to [Key Maps](#) for 101-key keyboard equivalent keypresses.

The keyboard is used to manually input data that is not collected otherwise. Almost any function that a full sized computer keyboard can provide is duplicated on the VMT keyboard but it may take a few more keystrokes to accomplish a keyed task.

When using the 60-key keyboard almost every key has two or three different functions. The primary alpha or numeric character is printed on the key.

For example, when the **2nd** key is selected pressing the desired second-function key produces the **2nd** character i.e. **2nd + F1** toggles the CAPS Lock function. The specific **2nd** character is printed above the corresponding key.

Bar Code Data Entry

The Thor VX8 supports an accessory bar code label reading device. Keyboard data entries can be mixed with bar code data entries. Any scanner that decodes the bar code internally and outputs an RS-232 data stream may be used. COM port 1 is designed to be used with a hand held tethered bar code scanner. Also, a Bluetooth bar code scanner can be used to enter bar code data into the Thor VX8.

COM1 must be set to +5V on pin 9 when using a tethered serial scanner. See [VMT Manager](#).

Touch Screen Entry

Note: The touch screen should be calibrated before initial use. See [Touch Screen Calibration](#).

Note: Always use the point of the stylus for tapping or making strokes on the display. Never use an actual pen, pencil or sharp object to write on the touch screen.

The touch screen input performs the same function as the mouse that is used to point to and click elements on a desk top computer. A stylus is used in the same manner as a mouse – single-tap or double-tap to select menu options, drag the stylus across text to select, hold the stylus down to activate slider bars, etcetera. Right-click is generated by tapping the mouse icon in the system tray. After tapping, the mouse icon highlights the right button of the icon in red. The next touch screen tap is treated as a right-click. The mouse icon then returns to the left button highlighted in red so subsequent taps are treated as left clicks.

Hold the stylus as if it were a pen or pencil. Touch an element on the screen with the tip of the stylus then remove the stylus from the screen. The touch screen responds to an actuation force (touch) of up to 4 oz. of pressure.

The touch screen can be used in conjunction with the keyboard and scanner.

- Touch the stylus to the field of the data entry form to receive the next data feed.
- The cursor begins to flash in the field.
- The unit is ready to accept data from either the keyboard, integrated scanner or a device connected to a serial port.

Note: The touch screen may be disabled. Please refer to [Disabling the Touch Screen](#).

Soft Keyboard Entry

The optional software keyboard provides a virtual keyboard on the touch screen. The soft keyboard is orderable in several configurations.

Note: When the virtual keyboard is displayed, the physical keyboard is still active, if attached. Therefore it is possible to input data from both keyboards.

Chapter 2: Hardware

Hardware Configuration

The Thor VX8 is available in many configurations. Please refer to [Technical Specifications](#) for available options.

Note: Using the [VMT Manager](#), Pin 9 of COM1 may be configured to provide 5 volts DC to power a bar code scanner or RI for serial transfer.

Power Input

Vehicle power input for the Thor VX8 is determined by the DC/DC power supply selected. The DC/DC power supply accepts input in the stated range and provides a conditioned 12V DC output for the Thor VX8.

If DC power is not available – for example, in an office environment – an optional external Universal Input Power Supply can be used to convert AC wall power to an appropriate DC level. See [Power Supply](#).

Uninterruptible Power Supply

A DC uninterruptible power supply (UPS) battery is included to maintain power to the Thor VX8 for a minimum of 15 minutes when vehicle power is not available (such as when a vehicle battery is being swapped). The UPS is configured via the VMT Manager.

Backup Battery

The Thor VX8 has a permanent lithium battery installed to maintain time, date and BIOS setup information. The backup battery is not user serviceable and should last five years with normal use before it requires replacement.

Note: This battery should only be changed by authorized service personnel.

PCMCIA Slot

Microsoft Windows Plug and Play operating system controls the PCMCIA cards. These cards are hot swappable per the CardBus/PCMCIA specifications. PCMCIA slots are optional.

Power Management

The Thor VX8 uses Microsoft Windows Power Management. The Thor VX8 has two operating modes: Normal and Standby.

In Normal operating mode all systems are powered up and the video display is on. The RS-232 ports, any installed PCMCIA cards are active. However, Microsoft Windows also allows the display and hard disks to be shut down in normal mode to conserve energy.

The Standby mode shuts down many devices such as the display and hard drives. For complete details on the standby mode, please refer to the Microsoft Help & Support (**Start > Help and Support**).



Physical Controls

Power Button

The power (on/off) button is a push button switch located on the front of the Thor VX8. The switch is a momentary switch. If the Thor VX8 is Off, pressing the power switch turns the Thor VX8 On. If the Thor VX8 is On, Windows determines the results of a power button press. For example, the Thor VX8 may be configured to:

- Shut down
- Hibernate
- Ignore the power button press
- Ask user to choose.

Power button behavior is configured by [selecting](#):

	Start > Control Panel > Power Options > Choose what the Power buttons do (Classic view) Start > Control Panel > Hardware and Sound > Power Options > Choose what the Power buttons do (Category view)
	Start > Control Panel > Power Options > Advanced (Classic view) Start > Control Panel > Performance and Maintenance > Power Options > Advanced (Category view)

Pressing and holding the power switch for several seconds forces a shutdown.

Note: Always turn the computer off prior to removing power cables.

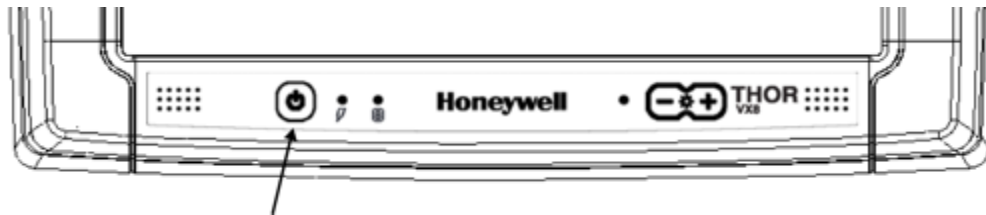

The Thor VX8 is designed for a controlled shutdown when using the power button. A controlled shutdown first closes any open programs, and then shuts down the Windows operating system. **DO NOT** remove power from the Thor VX8 without shutting down the Thor VX8.

The Thor VX8 shutdown may be initiated in any of the following ways:

- Selecting the **Shut Down** option from the Windows Start Menu.
- Selecting the **Shut Down** option from the Windows Task Manager. The Windows Task Manager is displayed by pressing Ctrl-Alt-Del.
- Momentarily pressing and releasing the power button. The Thor VX8 behavior when the power button is pressed can be configured in the Windows Control Panel.
- Pressing and holding the power button for approximately five seconds. Any open programs and the Windows operating system are shut down before power off. Note that this option must be used to shut down when the operating system is not responding.
- The VMT Manager can be configured so that an extended touch on the touch screen initiates the shut down process.

For more information on the Windows shutdown process, please refer to Help and Support on the Windows Start menu or commercially available Windows guides.

Display Brightness Buttons

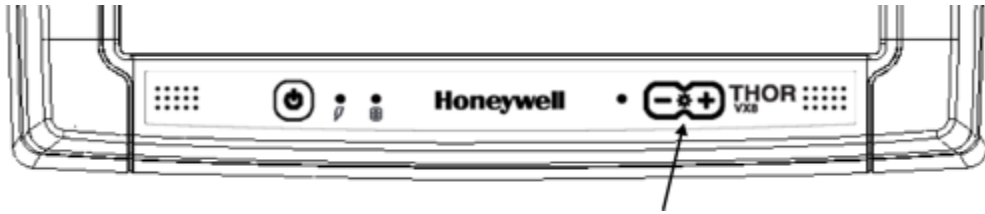

Screen brightness is adjusted using the buttons (+) or (-) on the front of the Thor VX8.

The screen's background lighting can be turned off by holding both buttons simultaneously.

Background lighting is restored by pushing one of the buttons or by touching the screen

The ambient-light autosensor is located on the front, to the left of the brightness controls.

Configuration of the ambient light control is handled via the [VMT Manager](#) option in the Control Panel.

External Connectors

Most external connectors for the Thor VX8 are located on the bottom of the unit.

- PS/2 connectors for Keyboard and Mouse.
- COM 1 connects to a serial bar code scanner cable.
- COM 2 connects to a serial printer or PC with the appropriate cables.
- The USB connectors are a standard USB type A host connector.
- The Ethernet connector is a standard RJ45 10/100 Ethernet connector.
- The multipurpose connector is a D15 connector that can provide a USB port, D9 serial RS-232 (COM4) port or both depending on the accessory cable attached to the connector.
- Audio connector is a 3.5 mm jack for audio out, i.e. a headset.
- Microphone connector is a 3.5mm jack for audio in, i.e. a microphone.
- External Bluetooth antenna connector.

Note: Pin 9 of the COM 1 can be switched between +5V and RI to change between a bar code scanner and a serial port printer or PC cable. See [VMT Manager](#).

Other external connectors are located as follows:

- 802.11 antenna connectors are located on the top of the Thor VX8. One of these connectors may also be used by the WWAN radio.

Serial Connector – COM1



COM1 provides +5v on pin 9 when enabled. Only COM1 should be used to connect an external scanner to the Thor VX8.

The serial connector, with a (1) label, (configured as COM1) is industry-standard RS-232. The connector includes a PC/AT standard 9-pin “D” male connector. The VMT Manager controls the function of pin 9. Pin 9 is capable of supplying +5 VDC for an external bar code scanner. Refer to [VMT Manager](#) for more information on configuring pin 9.

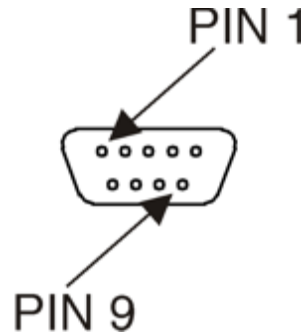

Pinout

Pin	Signal	Description
1	DCD	Data Carrier Detect – Input
2	RXD	Receive Data – Input
3	TXD	Transmit Data – Output
4	DTR	Data Terminal Ready – Output
5	GND	Signal/Power Ground
6	DSR	Data Set Ready – Input
7	RTS	Request to Send – Output
8	CTS	Clear to Send – Input
9	+5VDC or RI	Ring Indicator – Input (Default) or Bar code Scanner Power – 400mA max

Note: Pin 9 of the COM port can be switched between +5V and RI. See [VMT Manager](#).

Serial Connector – COM2



COM2 provides **+12v** on pin 9 when enabled.
Do not connect a serial bar code scanner to COM2 as this may damage the scanner, the Thor VX8 or both.

The COM2 serial connector is an industry-standard RS-232 9-pin “D” connector. The connector and its pin assignments are shown below.

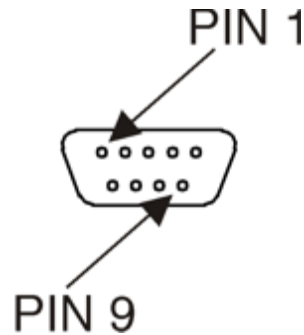

Pinout

Pin	Signal	Description
1	DCD	Data Carrier Detect – Input
2	RXD	Receive Data – Input
3	TXD	Transmit Data – Output
4	DTR	Data Terminal Ready – Output
5	GND	Signal/Power Ground
6	DSR	Data Set Ready – Input
7	RTS	Request to Send – Output
8	CTS	Clear to Send – Input
9	RI or +12VDC	Ring Indicator – Input (default) or Power – 400mA max

Note: Pin 9 of the COM port can be switched between +12V and RI. See [VMT Manager](#).

PS/2 Keyboard Connector

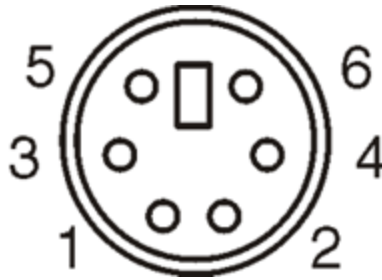

Pinout

Pin	Signal	Description
1	KBDAT_A	Keyboard Data
2	–	Not Connected
3	DGND	System Ground
4	KBD_PWR	Keyboard Power, 5V
5	KBCLK_A	Keyboard Clock
6	–	Not Connected
Shell	CGND	Chassis Ground

PS/2 Mouse Connector

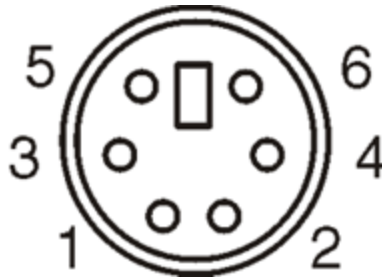

Pinout

Pin	Signal	Description
1	MSDAT_A	Mouse Data
2	–	Not Connected
3	DGND	System Ground
4	KBD_PWR	Keyboard Power, 5V
5	MSCLK_A	Mouse Clock
6	–	Not Connected
Shell	CGND	Chassis Ground

RJ45 Connector

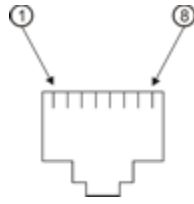

Pinout

Pin	Signal	Description
1	TXP	Transmit +
2	TXN	Transmit –
3	RXP	Receive +
4	–	Not Connected
5	–	Not Connected
6	RXN	Receive –
7	–	Not Connected
8	–	Not Connected

Multipurpose Connector

The Thor VX8 Ethernet/USB connector accepts a [dongle cable](#) that provides a USB port, an Ethernet port or both. The connector is shown below.

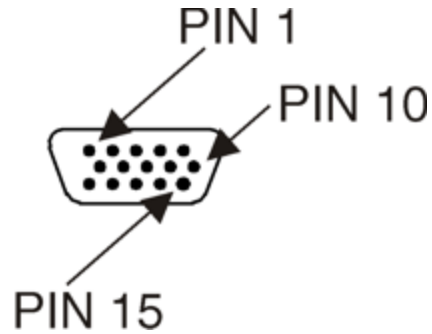

Pinout

Pin	Signal	Description
1	VCC 5	+5V power
2	RXD	Receive Data, COM4
3	TXD	Transmit Data, COM4
4	–	Not Connected
5	+12V	12V power supply
6	USB +	USB Data+
7	USB	USB Data
8	GND	Ground
9	–	Not Connected
10	GND	Ground
11	GND	Ground
12	RTS	COM4 Handshake
13	CTS	COM4 Handshake
14	–	Not Connected
15	–	Not Connected

Multipurpose Dongle Cables

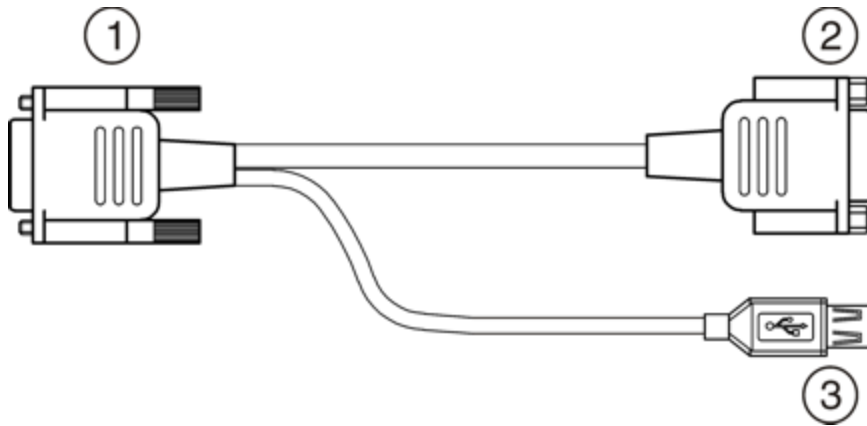

1. To D15 Connector on Thor VX8
2. D9 Serial Connector (COM4)
3. USB Connector



D15 Female Connector

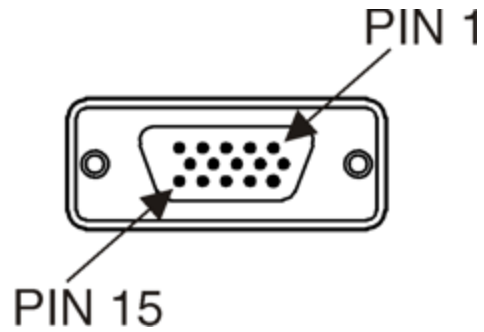

Pinout

Pin	Signal	Description
Pin	Signal	Description
1	VCC 5	+5V power
2	RXD	Receive Data, COM4
3	TXD	Transmit Data, COM4
4	–	Not Connected
5	+12V	12V power supply
6	USB +	USB Data+
7	USB	USB Data
8	GND	Ground
9	–	Not Connected
10	GND	Ground
11	GND	Ground
12	RTS	COM4 Handshake
13	CTS	COM4 Handshake
14	–	Not Connected
15	–	Not Connected

USB Connector

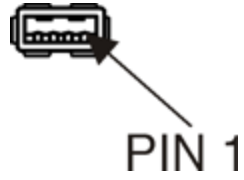

Pinout

Pin	Signal	Description
1	VCC	+5V USB Power
2	USB2N_A	USD D -
3	USB2P_A	USB D +
4	DGND	USB Power Return

Serial Connector - COM4



COM4 provides **+12v** on pin 9 when enabled.

Do not connect a serial bar code scanner to COM4 as this may damage the scanner, the Thor VX8 or both.

The COM4 serial connector is an industry-standard RS-232 9-pin "D" connector. The connector and its pin assignments are shown below.

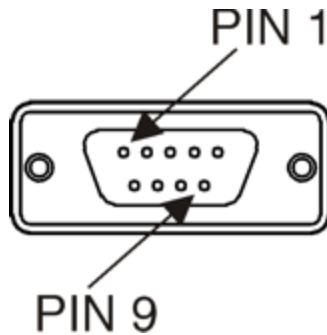

Pinout

Pin	Signal	Description
1	DCD	Data Carrier Detect – Input
2	RXD	Receive Data – Input
3	TXD	Transmit Data – Output
4	DTR	Data Terminal Ready – Output
5	GND	Signal/Power Ground
6	DSR	Data Set Ready – Input
7	RTS	Request to Send – Output
8	CTS	Clear to Send – Input
9	RI or +12VDC	Ring Indicator – Input (default) or Power – 400mA max

Note: Pin 9 of the COM port can be switched between +12V and RI. See [VMT Manager](#).

Audio and Microphone Connectors

Audio Out is a standard 3.5mm earphone outlet.

Microphone In is a standard 3.5mm microphone inlet.

Antenna Connectors

The Thor VX8 has up to four antenna connectors, depending on the options ordered.

Two antenna connectors are located on the top of the Thor VX8. If the Thor VX8 contains an 802.11 radio, these connectors provide diversity antennas for the radio. The connectors can also be used to connect a remote antenna.

Two antenna connectors are located on the bottom of the Thor VX8. These antenna connectors are for the Bluetooth antenna and the remote WWAN antenna.

Power Supply Connector

Power is supplied to the Thor VX8 through the power connector. Additionally this assembly provides for input for the screen blanking feature, if desired.

The Thor VX8 must be connected to either:

- an approved [AC to DC converter](#), or
- a [DC to DC power supply](#) delivering conditioned DC power.



Pinout

Pin	Signal
1	DC Positive (+)
2	Not connected
3	DC Negative (-)
4	Not connected
5	Screen blanking box (optional)
6	Screen blanking box (optional)

Keyboards

The following keyboard options are available for the Thor VX8:

- VMT 95-key QWERTY keyboard with integrated pointing device – a customized rugged keyboard connected to the Thor VX8 via an adapter cable.
- VMT 60-key QWERTY keyboard – a customized rugged keyboard connected to the Thor VX8 via an adapter cable.
- A standard PS/2 keyboard via the PS/2 Keyboard port on the Thor VX8. A PS/2 mouse can also be attached to the PS/2 Mouse port.
- A software keyboard, or virtual keyboard, can be displayed on the touch screen. The virtual keyboard can be used in place of, or in addition to, a physical keyboard.

95-key Keyboard

This keyboard contains an integrated pointing device. An adapter cable is required to attach this keyboard to the Thor VX8.



1. To adapter cable
2. To 90-key keyboard cable
3. To VX8 PS/2 keyboard connector (color coded)
4. To VX8 PS/2 mouse connector (color coded)

60-key Keyboard

An adapter cable is required to attach this keyboard to the Thor VX8.



1. To adapter cable
2. To 60-key keyboard cable
3. To VX8 PS/2 keyboard connector (color coded)
4. To VX8 PS/2 mouse connector (color coded)

95-key QWERTY Keyboard with Pointing Device

Designed for ease of use with Windows operating systems, the 95-key keyboard with pointing device connects via a cable to the keyboard port on the Thor VX8. Additional Windows keys (the Windows logo key and the Application key) and an integrated pointing device are provided for ease of use with Windows operating systems.

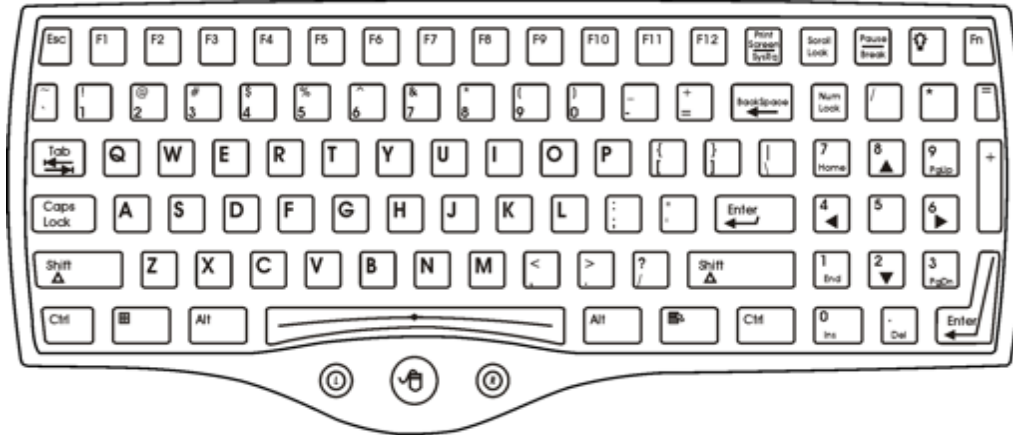

Key Maps

The 95-key keyboard supports all 104 keyboard functions (101 keyboard standard plus Windows keys) and includes an integrated pointing device and left and right mouse buttons. However, because the keyboard only has 95 keys, all functions are not visible (or printed on the keyboard). Therefore the Thor VX8 keyboard supports what is called hidden keys – keys that are accessible but not visible on the keyboard.

As with a standard keyboard, many keys are found in the Alphanumeric section as well as on the Numeric keypad (i.e. the 1 key is found on the numeric keypad and above the alpha characters on standard keyboards). However these keys send distinctly different scan codes when the keys are pressed. The hidden keys supported by the Thor VX8 are listed in [Key Maps](#).

Note: The 95-key keyboard does not have a 2nd key function.

NumLock

For the 95-key keyboard, the NumLock key and the numeric keys are backlit green when NumLock is off. When NumLock is on, the backlight for the NumLock key and the numeric keys is amber.

CapsLock and Scroll Lock

For the 95-key keyboard, the CapsLock key is backlit green when CapsLock is off. When CapsLock is on, the backlight for the CapsLock key is amber.

The Scroll Lock key is backlit green when Scroll Lock is off. When Scroll Lock is on, the backlight for the Scroll Lock key is amber.

The default values for CapsLock and Scroll Lock are Off.

Keyboard Backlight



The 95-key keyboard backlights each key with an LED. The keyboard backlight is manually controlled using the “backlight” key in the upper right hand corner of the keyboard. Pressing the backlight key cycles the keyboard backlight through the levels of backlight intensity:

- Off
- Maximum intensity
- Medium intensity
- Low intensity.

60-key QWERTY Keyboard

The 60-key keyboard has 101 keyboard functions, including a numeric keyboard pad. Please refer to [Key Maps](#) for keypress combinations.

The 60 key keyboard is also available with overlays designed for use with [IBM 3270](#) and [IBM 5250](#) terminal emulations.

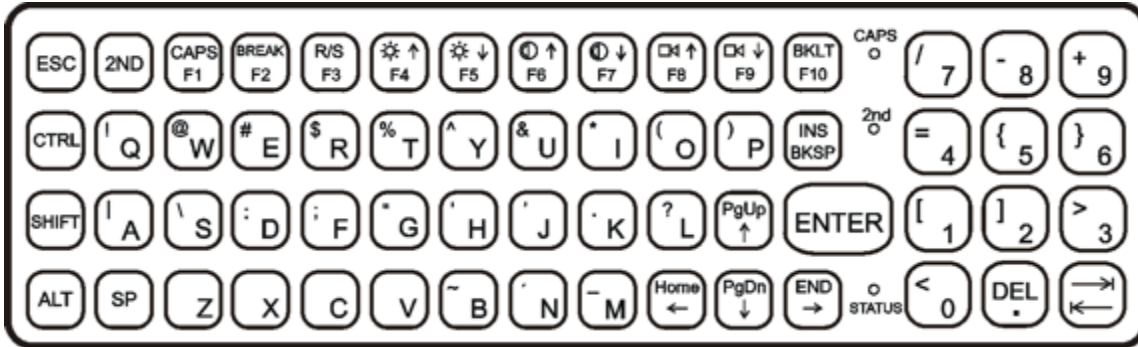

Key Maps

The 60-key keyboard supports all 101 keyboard functions. However, because the keyboard only has 60 keys, all functions are not visible (or printed on the keyboard). Therefore the Thor VX8 keyboard supports what is called hidden keys – keys that are accessible but not visible on the keyboard.

On standard keyboards many keys are found in the Alphanumeric section as well as on the Numeric keypad (i.e. the 1 key is found on the numeric keypad and above the alpha characters on standard keyboards). However these keys send distinctly different scan codes when the keys are pressed. The default codes for the Thor VX8 number keys correspond to the numeric keypad on standard keyboards. In order to duplicate the codes sent when the alphanumeric key is pressed, the hidden keystroke must be used.

The hidden keys supported by the Thor VX8 are listed in [Key Maps](#).

Unused Key Functions

There are several key functions on the 60-key keyboard that are not used on the Thor VX8. These include:

- **2nd F3** – The Resume/Suspend function is not used as Microsoft Windows controls all power management modes.
- **2nd F4** and **2nd F5** – The Display Brightness functions are not used as the display brightness is adjusted by the buttons on the Thor VX8.
- **2nd F6** and **2nd F7** – The Contrast functions are not used as the contrast is not adjustable on the TFT display on the Thor VX8.
- **2nd F8** and **2nd F9** – The Volume control keys are not used as volume is adjusted via the Microsoft Windows Volume icon in the System Tray.
- **2nd F10** – Please see below for details on toggling the keyboard backlight.

NumLock

The 60-key keyboard does not have a NumLock indicator or key. NumLock can be toggled On or Off using the **2nd SHIFT F10** keypress sequence. Changes made to the NumLock status persist across a Windows restart.

Keyboard Backlight

The keyboard keys are backlit with LEDs. The backlight is manually controlled using the **2nd + CTRL + F10** keypress sequence.

Control Keys

The VMT keyboard has several control keys. Because of the construction of the Thor VX8 and the Microsoft Windows operating system, many of the Control Keys are not used on the Thor VX8.

The 2nd functions of the **F4** and **F5** keys are not used as the display brightness is adjusted via the buttons on the Thor VX8.

The 2nd functions of the **F6** and **F7** keys are not used as the Thor VX8 has TFT LCD screen with no provision for contrast adjustments.

The 2nd functions of the **F8** and **F9** keys are not used as the sound volume on the Thor VX8 is controlled with the Sound icon in the Microsoft Windows System Tray.

The **F10** key is used to toggle the backlight as part of the keypress sequence **2nd + CTRL + F10**. This key sequence immediately toggles the status of the keyboard backlight. Pressing **2nd + F10** has no effect on the keyboard backlight.

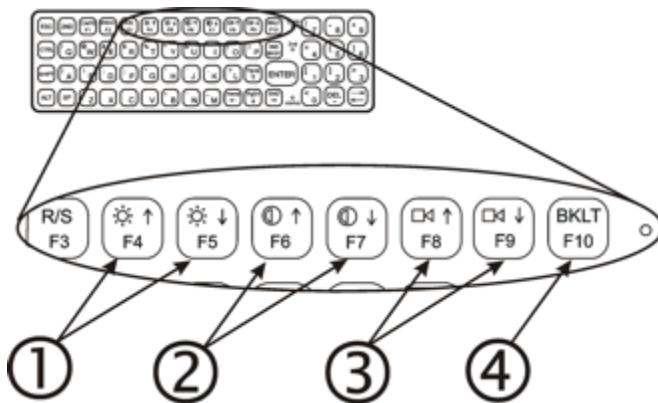

1. Display Brightness Control Keys (Not used)
2. Display Contrast Control Keys (Not used)
3. Speaker Volume Control Keys (Not used)
4. Backlight Control Key (See above)

Keyboard LEDs

The Thor VX8 keyboard has two (2) LED indicators.

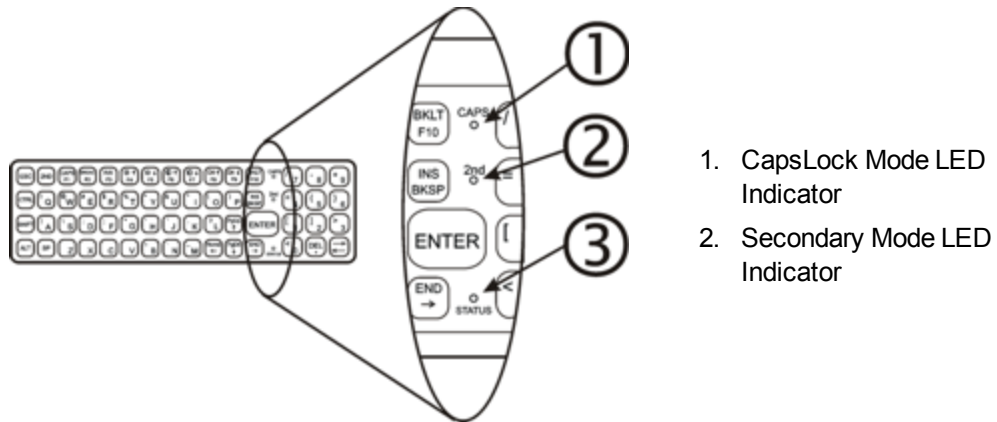

CAPS LED

This LED indicates the state of the keyboard CapsLock mode. If CapsLock is enabled this LED is illuminated green. When CapsLock is off, the LED is dark.

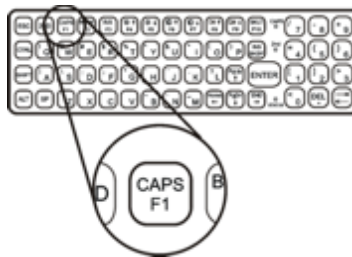

Press 2nd then F1 to toggle CapsLock On and Off.

The default value of CapsLock is "Off".

Secondary Keys LED

The VMT keyboard is equipped with several secondary keys. These keys are identified by the superscripted text found on the keyboard keys. The secondary keys are accessible by using two (2) keystrokes: the **2nd** key followed by the superscripted key.

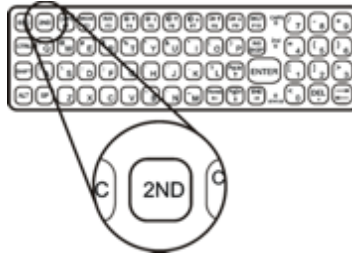

Once the 2nd state is enabled (by pressing the 2nd key) the Secondary Mode LED is illuminated and the 2nd state is enabled until another key is pressed. The 2nd key is toggled on with a 2nd keypress and then immediately off with another 2nd keypress.

For example:

Press 2nd and F1 to turn CapsLock on and off.

Press 2nd and ↑ (up arrow) to initiate the PgUp command.

Press 2nd and Q to type the “!” key.

Press 2nd and BkSp to enter the Insert (Ins) mode.

IBM 3270 Keypad Overlay

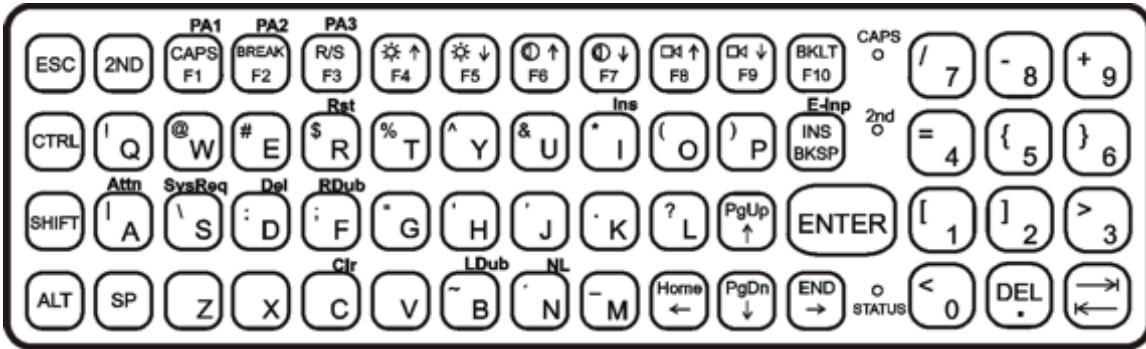

The 60-key keypad is available with an IBM 3270 overlay designed to allow the user to enter terminal emulator commands when running RFTerm.

IBM 5250 Keypad Overlay

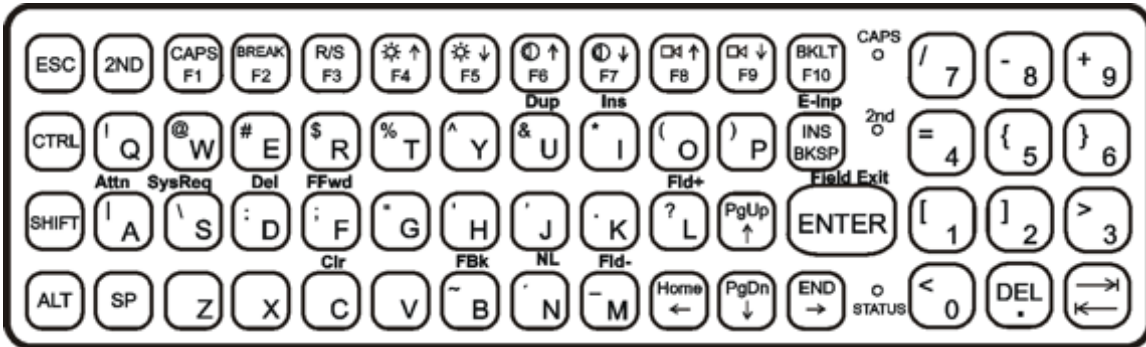

The 60-key keypad is available with an IBM 5250 overlay designed to allow the user to enter terminal emulator commands when running RFTerm.

General Windows Keyboard Shortcuts

Use the keyboard shortcuts in the chart below to navigate with any Thor VX8 keyboard. These are standard keyboard shortcuts for Windows applications.

Press these keys ...	To ...
CTRL + C	Copy
CTRL + X	Cut
CTRL + V	Paste
CTRL + Z	Undo
DELETE	Delete
SHIFT with any of the arrow keys	Select more than one item in a window or on the desktop, or select text within a document.
CTRL+A	Select all.
ALT+ESC	Cycle through items in the order they were opened.
CTRL+ESC	Display the Start menu.
ALT+Underlined letter in a menu name	Display the corresponding menu.
Underlined letter in a command name on an open menu	Carry out the corresponding command.
ESC	Cancel the current task.

The touch screen provides equivalent functionality to a mouse:

- A touch on the touch screen is equivalent to a left mouse click.
- Many items can be moved by the “drag and drop” method, touching the desired item, moving the stylus across the screen and releasing the stylus in the desired location.
- A double stylus tap is equivalent to a double-click.
- Right-click is generated by tapping the mouse icon in the system tray. After tapping, the mouse icon highlights the right button of the icon in red. The next touch screen tap is treated as a right-click. The mouse icon then returns to the left button highlighted in red so subsequent taps are treated as left clicks.

PS/2 Keyboard/Mouse

A standard PS/2 keyboard and mouse can be attached to the Thor VX8 using the two PS/2 connectors, one labeled “Keyboard” and one labeled “Mouse”. Please refer to documentation provided with the PS/2 keyboard and mouse for more information on their operation.

Virtual Keyboard

The optional software keyboard provides a virtual keyboard on the touch screen. The soft keyboard is available in several configurations.

Note: When the virtual keyboard is displayed, the physical keyboard is still active, if attached. Therefore it is possible to input data from both keyboards.

- Windows® Embedded Standard
- Windows® XP Embedded / Professional



For more information on configuring the virtual keyboard, click on **Start > Programs > MountFocus POS > Keyboard Control Panel**.

- Windows® 7 Professional



For more information on configuring the soft keyboard, click on the **Tools down arrow > Options > Opening** on the soft keyboard or **Start > Control Panel > Tablet PC Settings > Other > Go to Input Panel options**.

How To: Disable the Soft Keyboard

Windows 7 Professional only.

Open the on-screen Tablet PC Input Panel (see previous figure Soft Keyboard, Typical Configuration). Click the Tools down arrow > Options > Opening tab. Disable (uncheck) *For touch input, show the icon next to the text box*. Disable (uncheck) *Show the icon on the taskbar*. Disable (uncheck) *Use the Input Panel tab*. Click OK. The soft keyboard is disabled immediately. The soft keyboard is not restored on reboot.

How To: Enable the Soft Keyboard

Windows 7 Professional only.

Select Control Panel > Tablet PC Settings > Other. Click the link *Go to Input Panel Settings*. On the Opening tab, enable (check) *For touch input, show the icon next to the text box*. Enable (check) *Show the icon on the taskbar*. Enable (check) *Use the Input Panel tab*. Click OK. The soft keyboard is enabled immediately.

Display

The Thor VX8 Display is capable of supporting SVGA graphics modes. The display covering is designed to resist stains. The touch screen allows signature capture and touch input. A display optimized for outdoor viewing is available.

The display supports screen blanking to eliminate driver distraction when the vehicle is in motion. Please see [Screen Blanking Box](#) for details.

Cleaning the Display

Keep fingers and rough or sharp objects away from the display. If the glass becomes soiled or smudged, clean only with a standard household cleaner such as Windex® without vinegar or use Isopropyl Alcohol. Do not use paper towels or harsh-chemical-based cleaning fluids since they may result in damage to the glass surface. Use a clean, damp, lint-free cloth. Do not scrub optical surfaces. If possible, clean only those areas which are soiled. Lint/particulates can be removed with clean, filtered canned air.

Touch Screen

The touch screen is a Resistive Panel with a scratch resistant finish that can detect touches by a stylus, and translate them into computer commands. In effect, it simulates a computer mouse. Only Delrin or plastic styluses should be used.

The touch screen is available in standard, hardened and defroster versions.

Note: Always use the point of the stylus for tapping or making strokes on the display. Never use an actual pen, pencil or sharp object to write on the touch screen.

An extra or replacement stylus may be ordered from Honeywell.

Please refer [here](#) for more information, including:

- Calibrating the touch screen
- Disabling the touch screen.

PCMCIA Slot (Optional)

The Thor VX8 has an optional PCMCIA slot. The PCMCIA slot is only installed if the Thor VX8 is ordered with a WWAN radio. The PCMCIA slot is behind the hard drive cable, indicated by the arrow in the illustration below.



PCMCIA Card Management is handled by Microsoft Windows. The PCMCIA cards are Plug and Play devices and can be “hot swapped”. For more details, refer to Help and Support on the Windows Start menu or refer to the documentation delivered with the PCMCIA card.

Install PCMCIA Cards

Equipment Needed: Torx 20 screwdriver

1. Turn the Thor VX8 off and detach the power cable.
2. Loosen the three (3) Torx 20 screws securing the service hatch so the cover can be removed. The screws are a captive part of the cover and cannot be removed. Use care not to dislodge or break antenna cables.
3. Insert the PCMCIA card into the slot.
4. Reattach the service panel and tighten the screws.
5. Re-connect the power cord/cable and turn the Thor VX8 on.

PCMCIA Pinout

Pin	Signal	Pin	Signal	Pin	Signal
1	GND	24	A5	47	A18
2	D3	25	A4	48	A19
3	D4	26	A3	49	A20
4	D5	27	A2	50	A21
5	D6	28	A1	51	SLOT_VCC
6	D7	29	A0	52	SLOT_VPP
7	-CE1	30	D0	53	A22
8	A10	31	D1	54	A23
9	-OE	32	D2	55	A24
10	A11	33	WP/A_-IOIS16	56	A25
11	A9	34	GND	57	n.c. or VS2#
12	A8	35	12V_RF_POWER	58	RESET
13	A13	36	-CDI	59	-WAIT
14	A14	37	D11	60	-INPACK
15	-WE	38	D12	61	-REG
16	RDY/-IREQ	39	D13	62	BVD2/-SPKR
17	SLOT_VCC	40	D14	63	BDV1/-STSCHG
18	SLOT-VPP	41	D15	64	D8
19	A16	42	-CE2	65	D9
20	A15	43	n.c. or VS1#	66	D10
21	A12	44	-IORD	67	-CD2
22	A7	45	-IOWR	68	GND
23	A6	46	A17		

Power Supply

Vehicle power input for the Thor VX8 is dependent on the power supply selected. Availability of power supplies may vary by region:

VX89A301PSDC9TO36V, Power Supply, DC/DC for 9-36V trucks, 60W

VX89A302PSDC48V, Power Supply, DC/DC for 18-60V trucks, 60W

VX89A303PSDC60TO110V, Power Supply, DC/DC for 50-150V trucks, 60W

Important – A DC to DC power supply is required to provide a conditioned power source to the Thor VX8. The Thor VX8 cannot be connected to vehicle power without the DC to DC power supply.

If DC power is not available – for example, in an office environment – an optional external [AC Power Supply](#) can be used to convert AC wall power to an appropriate DC level.

Please review the installation cautions and warnings contained in the *Thor VX8 Vehicle Mounting Reference Guide*.

Vehicle DC Connection

Note: Correct electrical polarity is required for safe and proper installation. Connecting the cable to the Thor VX8 with the polarity reversed will cause the Thor VX8's fuse to be blown. See the following figures for wire color-coding specifics.

Power Cable Routing without Screen Blanking

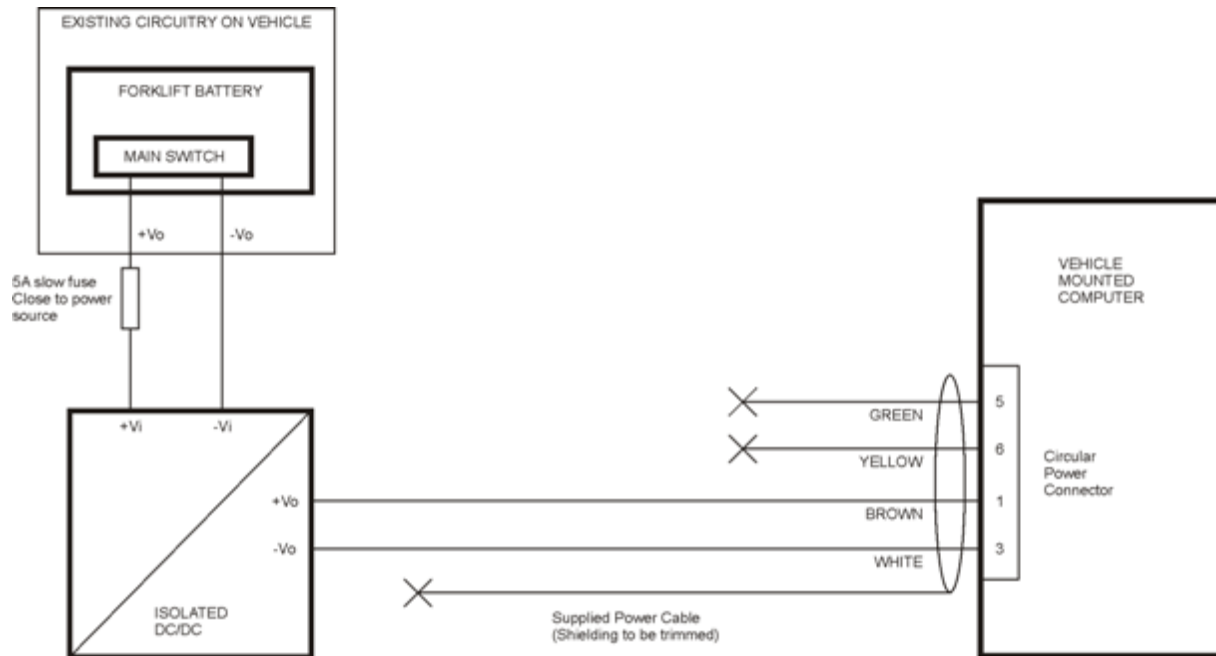

Power Cable Routing with Screen Blanking Box

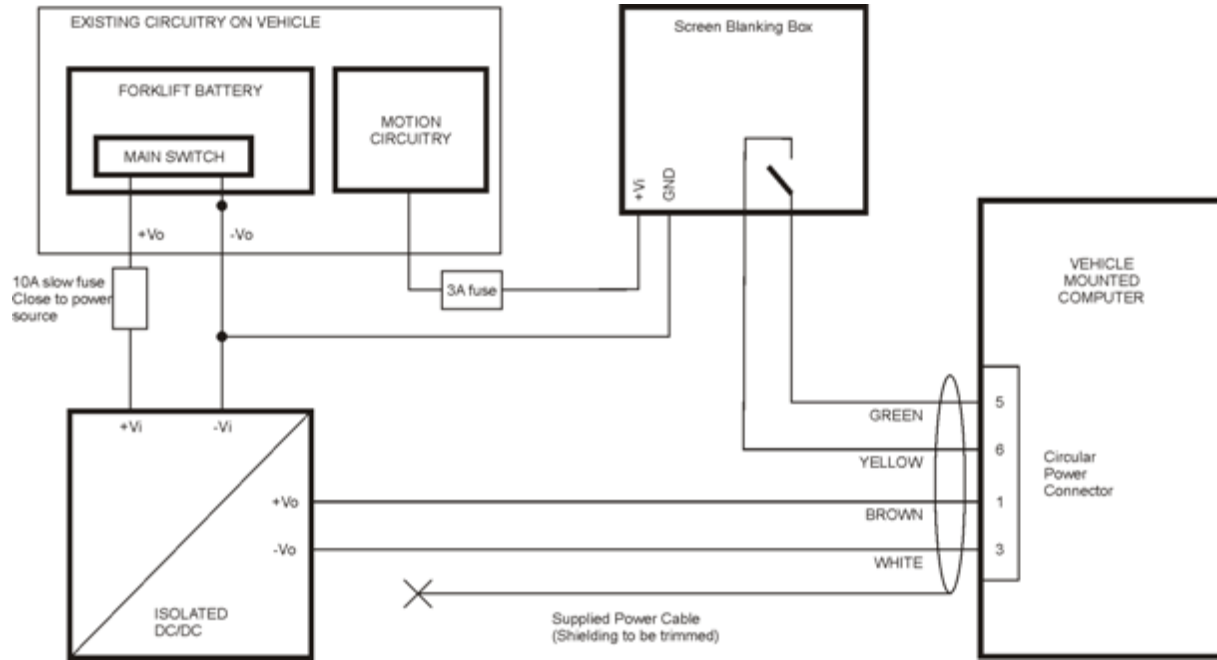

Connection with Relay/Mechanical Switch for Screen Blanking

In the example below, a user supplied relay/switch that supplies a mechanical electrically conductive connection on vehicle motion is used.

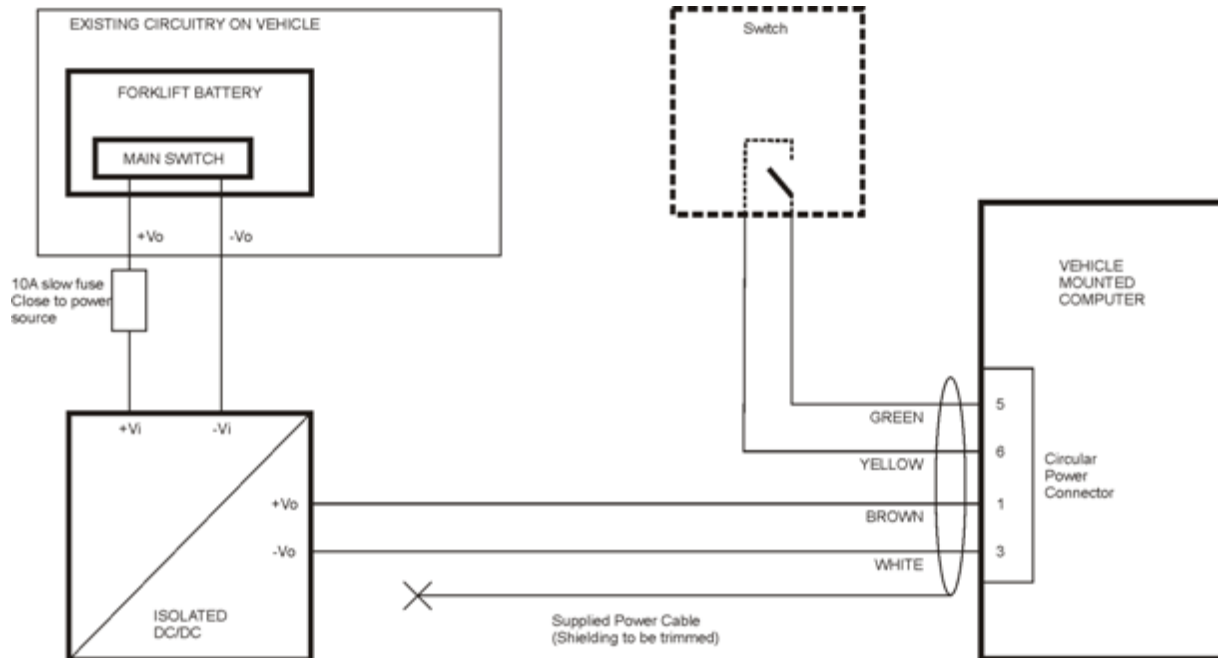

Screen Blanking

When properly configured and wired as shown above with either a screen blanking box or mechanical switch, the Thor VX8 screen blanking blanks the when the vehicle is in motion. The screen blanking behavior can be configured using the [VMT Manager](#).

Uninterruptible Power Supply Battery Pack

An Uninterruptible Power Supply (UPS) is built into the Thor VX8 to provide power for short periods of time when vehicle power is unavailable (such as when vehicle batteries are swapped). The UPS, when enabled, can be used to power the Thor VX8 for a specified period of time before shutdown.

Configuration of the UPS is handled via the [VMT Manager](#) option in the Control Panel..

External Power Supply

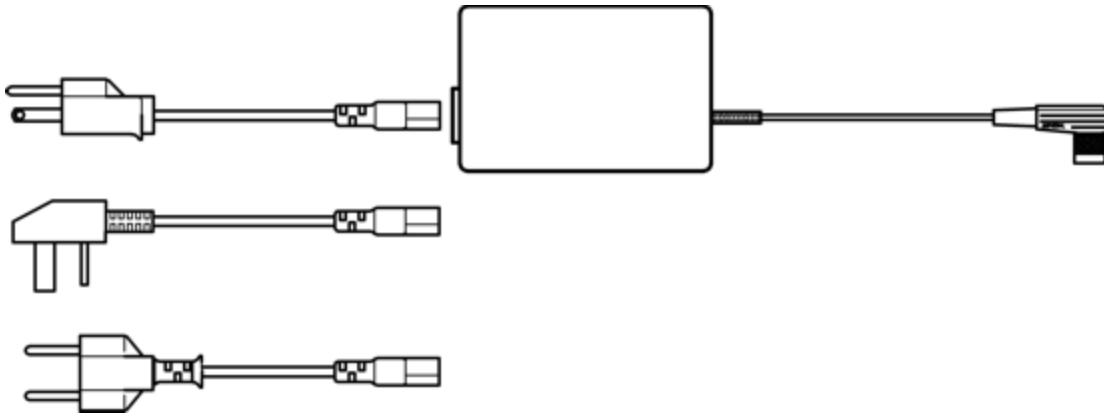

Note: Requires country specific AC power cord.

Please refer to the *Thor VX8 Vehicle Mounting Reference Guide* for details on connecting the external AC power supply.

CMOS Battery

The Thor VX8 has a permanent Lithium battery installed to maintain time, date and CMOS setup information. The lithium battery is not user serviceable and should last five years with normal use before it requires replacement.

Note: This battery should only be changed by authorized service personnel.

Hardware Problems

This section lists possible solutions to some common problems with hardware.

Power Source

The Thor VX8 receives power from either an AC-DC adapter or a vehicle battery. Power source problems are usually interrelated. For example, a malfunctioning AC-DC adapter or vehicle battery will not power the computer.

ATTENTION

Using the wrong AC adapter or DC converter could damage the Thor VX8. Honeywell assumes no liability for damage to the Thor VX8 or adapter/converter caused by using the wrong adapter/converter.

The following table provides solutions to common power source problems:

Problem	Solution
The computer won't start.	Make sure you've attached the power cord properly and that you have the power switch in the On position.
	Make sure the wall outlet (for AC-DC adapter) is working or the vehicle battery is charged.
	Check all inline fuses and replace if blown.
	Make sure the vehicle battery is connected properly to the Thor VX8 power cable.

Contact your [representative](#) if you cannot find the source of the problem.

Keyboard

The following table provides solution to common keyboard problems:

Problem	Solution
No characters generated on keypress.	Verify that all keyboard cables are securely attached and that any set screws on the cable/adapter are tightened.
Get an unexpected character or function when pressing some keys.	Reboot the machine to return to its original setting. If the problem continues refer to the key map for correct key combinations.
The 2nd key on the keyboard remains active and does not toggle on and off when another key is pressed.	Press the SP key or an arrow key to release the 2nd state. Contact your representative if the problem continues. <i>The 95-key keyboard does not have 2nd key functionality.</i>
The keyboard locked and you cannot use Ctrl + Alt + Del to reboot.	Press and hold the power button to shutdown then press again to restart the computer.

Display / Touch Screen

Problem	Solution
The display is unreadable.	Verify the Display setting in the Microsoft Windows Control panel. The display settings should be set to High Color (16 bit) and 800 by 600 pixel resolution. <i>It may be necessary to reboot in Safe Mode to change the display settings if the screen is unreadable. See Bypassing Microsoft Windows Startup.</i>
Touch screen taps are	Recalibrate the touch screen. Select Start > Programs > UPDD > Calibrate .
Touch screen is not working	View the UPDD settings (Start > Programs > UPDD > Settings). With Hardware selected, the screen should say: Handling whole desktop Connected to COM3 If this is correct, click on the Calibrate button and calibrate the touch screen. If the hardware area is blank, add a new device. Chose "LXE, AHL serial", set desktop to "whole" and set the serial port to "COM3". Click on the calibrate icon to complete the process. Contact your representative if the device choice does not include a listing similar to the one above.

Hard Disk Drive

If you have problems with the hard disk drive, run the Microsoft Windows disk checking utility. This utility analyzes the directories, files and File Allocation Tables (FAT).

Right-click the **Computer** or **Local Disk** icon, then click **Properties > Tools > Error checking** then click the **Check now** button. Contact your [representative](#) if the scandisk utility does not report any errors and the hard disk still has problems.

For information on running the disk checking utility, refer to Help and Support on the Windows Start menu.

Memory Conflicts

Microsoft Windows controls memory management. If you experience a problem with memory management, please refer to Help and Support on the Windows Start menu or a commercially available Windows guide. If a particular program causes the memory error, refer to the documentation for that program.

Optional Devices

This section provides information on solving problems related to optional devices.

Note: Make sure the Thor VX8 is powered on before you turn on any powered optional devices.



Only connect a serial bar code scanner to COM1. Be sure Pin 9 of COM1 is configured to provide +5V. Do not connect a serial bar code scanner to COM2 or COM4 as damage to the Thor VX8, the scanner or both may result.

To help determine which device is causing the problem:

- Check that all connecting cables are correctly and firmly attached. Loose cables can cause erroneous or intermittent signals. You may need to inspect connecting cables for loose wires, and check connectors for loose pins.
- Isolate the problem. Look in the Microsoft Windows Control panel System icon for devices displaying a “?” or an “!”. Check the properties for these devices or delete these devices and reinstall them.
- Device Configuration. The smooth operation of the system depends on the interaction of all devices, programs and features. Is the device Plug and Play or is configuration necessary?
- Device driver. Make sure the correct driver is installed for the device, based on the version of Microsoft Windows operating system you are using. Check the documentation for the device or the device manufacturer’s website for an updated driver.

For information adding or deleting devices or updating drivers, please refer to Help and Support on the Windows Start menu or commercially available Windows guides.

The following table provides some solutions to common configuration problems:

Problem	Solution
You connected a device and the device isn’t operating properly.	Verify Microsoft Windows recognizes the device by checking the System icon in the Control Panel. Check for a problem with the device driver or a hardware conflict.
You connected an external device and the computer isn’t operating properly.	Check all cables and connectors. Try a different cable. If the Thor VX8 was on when the device was attached, reboot the Thor VX8.



Chapter 3: Software

Introduction

Like any personal computer, there are many aspects to the setup and configuration of the Thor VX8. Much of the setup and configuration of the Thor VX8 is dependent upon the optional features (both hardware and software) installed on the computer. Since the Thor VX8 uses the Microsoft Windows Plug and Play operating system, much of the hardware setup is automatic. The examples found in this section are to be used as samples only; the configuration of your specific computer may vary. The following sections provide a general reference for the configuration of the Thor VX8 and its optional features.

Please refer to commercially available Microsoft Windows user guides or to Windows on-line Help application for more information on Windows' options for system configuration.

Operating System

The Thor VX8 is available with the following operating systems:

- Windows® 7 Professional
- Windows® XP Professional
- Windows® Embedded Standard
- Windows® XP Embedded

The Thor VX8 can support only one operating system at a time. Information in this guide includes instruction for all operating systems. Differences are highlighted as follows:

- Windows® 7 Professional
- Windows® Embedded Standard
- Windows® XP Embedded
- Windows® XP Professional

BIOS Setup

When ordered, Microsoft Windows is installed on the Thor VX8 before shipping. The default BIOS parameters are configured at that time. In most cases, it is unnecessary to modify the BIOS parameters.

Generally, it is only necessary to enter the BIOS setup to change the boot order of the drives.

This section is not intended to detail all features of the BIOS, instead it is intended to cover the most commonly used setup options.

Note: Some BIOS parameters described in this section may not be available on all Thor VX8's.

<p>Caution:</p> 	<p>Be very careful when using this utility to modify BIOS Setup parameters. The Thor VX8 may generate unexpected results when incorrect or conflicting parameter values are entered. Selecting incorrect or invalid options may require the Thor VX8 to be returned for repairs.</p> <p>The parameters should only be modified by Information Services personnel or the system administrator.</p>
---	---

Note: Make sure there is an uninterrupted power supply connected to the Thor VX8 before accessing BIOS Setup.

Note: Settings are saved temporarily as each parameter activity screen is closed. Changes are saved to CMOS RAM when Exit With Save is selected and the BIOS setup program closes.

Note: Changed parameter values take effect when the Thor VX8 reboots upon exiting BIOS Setup. If the Thor VX8 does not automatically reboot upon exit, please reboot the Thor VX8.

Note: Many items, like Power Savings and Keyboard repeat rate/delay may be configured via the Microsoft Windows Control panel.

Accessing the BIOS Setup

For assistance in determining the type of BIOS installed on your Thor VX8, please refer to [Technical Specifications](#).

Note: The "Press F2 to Enter Setup" or the "Press Del to run Setup" message may be disabled in the BIOS. The F2 key or the Del key still has the same function when the display of the message is disabled.

AMI BIOS

When you turn an Thor VX8 with **AMI BIOS** on, the unit starts to boot. Watch the bootup sequence and when the following is displayed:

Press DEL to run Setup

Press the **Del** key.

Follow the on screen prompts for cursor movement, allowable values, online help, etc.

Phoenix BIOS

When you turn an Thor VX8 with **Phoenix BIOS** on, the unit starts to boot. Watch the bootup sequence and when the following is displayed:

Press F2 to Enter Setup

Press the **F2** key.

Follow the on screen prompts for cursor movement, allowable values, etc.

Identifying Drives in the Thor VX8

AMI BIOS

The **IDE Configuration** menu identifies the drives detected in the Thor VX8. The default is for all drives to be automatically detected.

Phoenix BIOS

The **Main** menu identifies the drives detected in the Thor VX8. The default is for all drives to be automatically detected.

Integrated Devices

AMI BIOS

The **Onboard Device Configuration** menu contains options for integrated devices like the serial ports and audio controller. Legacy USB support is configured on the **USB Configuration** menu.

Phoenix BIOS

The **Advanced** menu contains configuration options for integrated devices like the serial ports, onboard LAN and Legacy USB support.

Boot Priority

AMI BIOS

The **Boot** menu lists the boot devices in order. The default order is:

- Removable Device
- CD/DVD
- Hard Disk Drive (name may vary by drive type)
- USB Hotplug floppy drive
- Network

Phoenix BIOS

The Boot menu lists the boot devices in order, as well as any devices excluded from boot order.

The default boot order is:

- USB HDD
- USB CD-ROM
- USB Key
- IDE 0 (hard drive)
- IDE 1
- IDE 2
- IDE 3
- IDE CD

Devices excluded from boot order are:

- USB FDC
- USB ZIP
- USB LS120
- PCI BEV
- PCI SCSI
- Bootable add in cards.

PXE - Pre Boot Execution

AMI BIOS

Onboard Lan Boot Rom must be enabled, see **Onboard Device Configuration** menu.

Network must be set in the boot order before any other available options, see **Boot** menu.

Phoenix BIOS

Onboard PXE ROM must be enabled, see the **I/O Device Configuration** menu.

Exit BIOS Configuration

AMI BIOS

- **Save Changes and Exit** - Use this option to immediately save current Setup settings to CMOS RAM and into the Flash Boot Device (FBD). When this option is highlighted, press **Enter** to save. When the saving process is complete, the Thor VX8 reboots with the current values.
- **Discard Changes and Exit** - Use this option when any current changes made to Setup parameters are to be ignored. The parameters revert to their state when Setup was entered. When this option is highlighted, press **Enter** and the boot process continues. The system reboots with unchanged values.
- **Discard changes** - Use this option to immediately restore CMOS RAM and discard any changes to the current Setup.
- **Load Optimal Defaults** - Use this option to load default settings to run the system at optimal performance. Then select **Save Changes and Exit** to save and reboot.
- **Load Failsafe Defaults** - Use this option to load failsafe settings after changes may have made the system unstable. While these settings may result in minimized performance compare to the previous choice, they system should be returned to a stable state. Then select **Save Changes and Exit** to save and reboot.

Phoenix BIOS

Pressing the ESC key immediately brings up the Exit menu.

The choices are:

- **Exit Saving Changes** - Use this option to immediately save current Setup settings to CMOS RAM and into the Flash Boot Device (FBD). When this option is highlighted, press **Enter** to save. When the saving process is complete, the Thor VX8 reboots with the current values.
- **Exit Discarding Changes** - Use this option when any current changes made to Setup parameters are to be ignored. The parameters revert to their state when Setup was entered. When this option is highlighted, press **<Enter>** and the boot process continues. The system reboots with unchanged values.
- **Load Setup Defaults** - This option is used to reset the Setup values to the original, default values that were set at the factory, before suppliers or end users made changes. The next time the Thor VX8 is turned on or rebooted, those saved values are in effect. Save this change by selecting **Exit Saving Changes**.
- **Discard Changes** - Use this option to immediately restore CMOS RAM and update the current Setup settings from the Flash Boot Device. Save this change by selecting **Exit Saving Changes**.
- **Save Changes** - Used to save BIOS Setup changes without rebooting. The changed parameters are in effect the next time the Thor VX8 is powered on or rebooted. Reboot by selecting either **Exit Discarding Changes** or **Exit Saving Changes**.

VMT Keyboard Backlighting

95-key Keyboard

This keyboard has keys that are backlit with LEDs. The backlight is manually controlled using the “backlight” key in the upper right hand corner of the keyboard. Pressing the backlight key cycles the backlight through the levels of backlight intensity:

- Off
- Maximum intensity
- Medium intensity
- Low intensity.

60-key Keyboard

This keyboard has LEDs that illuminate the individual keys. The keyboard backlight may be toggled manually by pressing **2nd + CTRL + F10**. This key sequence immediately changes the state of the keyboard backlight as follows:

- Turns the backlight Off if it is currently On.
- Turns the backlight On if it is currently Off.

Microsoft Windows Setup and Configuration

Options for the Thor VX8 include Windows 7 Professional, Windows XP Professional, Windows Embedded Standard and Windows XP Embedded.

After the system files are processed, Microsoft Windows begins to load. Windows maintains a System Registry and INI files. Standard Windows configuration options apply to the Thor VX8. Configuration options are located in either the System Tray or the Control Panel:

- The System Tray contains icons for adjusting the time, date or volume level.
- The Control Panel contains icons for many other configuration options, such as Power Management, PC Cards, etc.
- The Control Panel icons are also used to add, delete or modify hardware installed on the Thor VX8.

Please refer to Help and Support on the Windows Start menu or commercially available Windows guides for more information on configuration options in Windows.

Microsoft Windows License Agreement (First Boot)



If your Thor VX8 is shipped with a Microsoft Windows operating system pre-installed, it may be necessary to complete the Windows licensing/registration screens when starting the Thor VX8 for the first time. To complete this information, you may need the Microsoft Windows software key that was included with the Thor VX8 or your copy of Windows.

When Microsoft Windows is started by the user for the first time (known as the “out of the box experience”), a series of questions may be presented. If prompted, the product key (printed on a decal attached to the Thor VX8) must be entered. The series of prompts and responses allow the user to configure Microsoft Windows on the Thor VX8 according to the user’s needs.

Proceed with the remainder of the boot process.

If you are loading your own version of Windows, you need a [drivers CD](#) to install device drivers.

Drive C Directory Structure

The drive C: directory structure is the same for all media types. Microsoft Windows is installed in the \Windows directory. In addition, Microsoft Windows creates other directories and several subdirectories. For more information on the directories Microsoft Windows uses, please refer to commercially available Windows reference guides.

Depending on the option ordered, drive C: may be:

- a rotating drive, current option is a 60 GB drive
- a flash drive, current options include 2, 8 or 16 GB

Please refer to the invoice or packing list if there are any questions about the configuration of your Thor VX8.

ATTENTION: On a Thor VX8 with a flash drive, powering off the Thor VX8 before a write (to disk) function has completed, may result in the corruption of the flash drive.

Software Loaded on Drive C

The software loaded on the Thor VX8 computer consists of:

- BIOS
- Microsoft Windows 7 Professional, Windows XP Professional or Windows Embedded Standard
- device drivers
- radio software
- touch screen software
- RFTerm[®] software (optional)

The software installed on the Thor VX8 is summarized below.

Note: Due to the complex directory structure and System Registry under Microsoft Windows, software should not be removed manually. Instead use the Add/Remove Programs icon in the Windows Control Panel.

Microsoft Windows

Microsoft Windows is installed in the \Windows subdirectory, which is the Windows default. In addition, Windows places files in other directories and subdirectories during installation. For more information, please refer to commercially available Windows user guides. Use the Windows Control Panel for Windows configuration.

Device Drivers

Device drivers are installed for all installed hardware options, such as the display, touch screen, radios, Ethernet port, etc. For more information on Microsoft Windows device drivers, please refer to commercially available Windows guides.

Radio Software

The Thor VX8 is delivered with the radio software installed. Because the Thor VX8 uses a Microsoft Windows operating system, the radio installation includes Windows device drivers.

Touch Screen Software

UPPD software is installed for calibrating the Thor VX8's touch screen. Please see [Touch Screen Calibration](#) for more information.

RFTerm[®] Software

RFTerm allows users to connect to applications running on IBM 3270, AS/400 and VT hosts from the Thor VX8 mobile computer over a wireless TCP/IP data network. When ordered, RFTerm is pre-installed on the device.

VMT Manager



The VMT Manager located in the Windows Control Panel is used to configure many of the unique features of the Thor VX8.

Thor VX8 Configuration Options

Many configuration options are available via the Microsoft Windows Control panel. For additional information, please refer to **Help and Support** on the **Start** menu for configuration details.



Date and Time

Use the [Windows interface](#) to set date, time and time zone. Tap the time displayed in the task bar or tap:

	Start > Control Panel > Clock, Language and Region > Date and Time (Category view) Start > Control Panel > Date and Time (Classic view)
	Start > Control Panel > Date and Time (Classic view) Start > Control Panel > Date, Time, Language and Regional Options > Change the Date and Time (Category view)

Power Management



Use the Windows interface to set power management options.

	Start > Control Panel > Hardware and Sound > Power Options (Category view) Start > Control Panel > Power Options (Classic view)
	Start > Control Panel > Power Options (Classic view), or tap Start > Control Panel > Performance and Maintenance > Power Options (Category view)

Speaker Volume



Use the Windows interface to control speaker volume.

Use the Windows interface to control speaker volume. Tap the speaker icon in the task bar or tap:

	Start > Control Panel > Hardware and Sound > Sound (Category view) Start > Control Panel > Sound (Classic view)
	Start > Control Panel > Sound and Audio Devices > Sounds (Classic view), or tap Start > Control Panel > Sounds, Speech and Audio Devices > Adjust the System Volume (Category view)



Connect Bluetooth Devices

Use the Windows interface to manage Bluetooth devices. Tap the Bluetooth icon in the task bar, if it exists, or:

	Tap the Bluetooth icon on the Desktop.
	Start > Control Panel > Bluetooth Devices (Classic view), or tap Start > Control Panel > Printers and Other Hardware > Bluetooth Devices (Category view)

Restart/Shutdown

Use the Windows interface to restart or shut down the Thor VX8.

	Start > Shut down <i>right arrow list menu</i> > Restart Start > Shut down
	Start > Shut down > Restart Start > Shut down > Shut down

Soft Keyboard

The optional soft keyboard can be enabled and configured from the keyboard control panel in the MountFocus software.

Tap **Start > Programs > MountFocus POS > Keyboard Control Panel**

Calibrate Touch Screen

To calibrate the touch screen, access the touch screen software, select:

- Tap **Start > Programs > UPDD > Calibrate** and touch the center of the cross displayed on screen and release. Repeat as the cross is displayed in various locations. The utility closes automatically upon calibration completion.

Touch Screen

Calibrating the Touch Screen

Although the touch screen is installed and calibrated at the factory, users may make adjustments to the calibration. To calibrate the touch screen, select **Start > Programs > UPDD > Calibrate**.



The calibration utility displays a cross on the screen. Touch the center of the cross with the stylus and hold for a few seconds. Release and repeat with the next cross. After all locations have been touched, the calibration utility automatically closes.

If no input is received, the calibration utility times out. Press ESC to exit the calibration utility without saving any changes.

Disabling the Touch Screen

If desired, the touch screen can be disabled in the Windows control panel. Once disabled, the touch screen remains disabled until it is enabled again.

To disable the touch screen, [select](#):

	Start > Control Panel > System > Device Manager > Mice and other pointing devices
	Start > Control Panel > System > Hardware > Device Manager > Mice and other pointing devices

Click on the list. In the list is a listing for Universal Pointer Device Driver. Right-click on this listing and select Disable from the menu.

To enable the touch screen, follow the same process, selecting Enable from the right-click menu.

Network Configuration

There are several networking options available for the Thor VX8.

802.11 Wireless Radios

Please refer to the instructions for configuring the 802.11 a/b/g/n, 802.11 b/g or 802.11 a/b/g radio in [Wireless Network Configuration](#).

Ethernet Connector

When the Thor VX8 is networked using the Ethernet connector, the Thor VX8's networking options are set via the Microsoft Windows Control Panel. The same networking configuration options are available as in a standard PC.

For more information on configuring the Microsoft Windows network settings, please refer to Help and Support on the Windows Start menu or commercially available Windows networking literature.

WWAN

Please refer to the instructions for configuring the WWAN radio in [Wireless Network Configuration](#).

Bluetooth

Please refer to the [information](#) on configuring the Bluetooth radio.

VMT Manager

The VMT Manager is used to configure many of the Thor VX8 options.

If using Classic view for the control panel, click on the **VMT Manager** icon.

If using Category view for the control panel, click on **Other Control Panel Options** and then the **VMT Manager** icon to launch the VMT Manager application.

Main Tab

The **Main** tab shows the embedded controller's firmware version and build date as well as the Thor VX8 computer manager application version and build date.

There are no user configurable options on this tab.

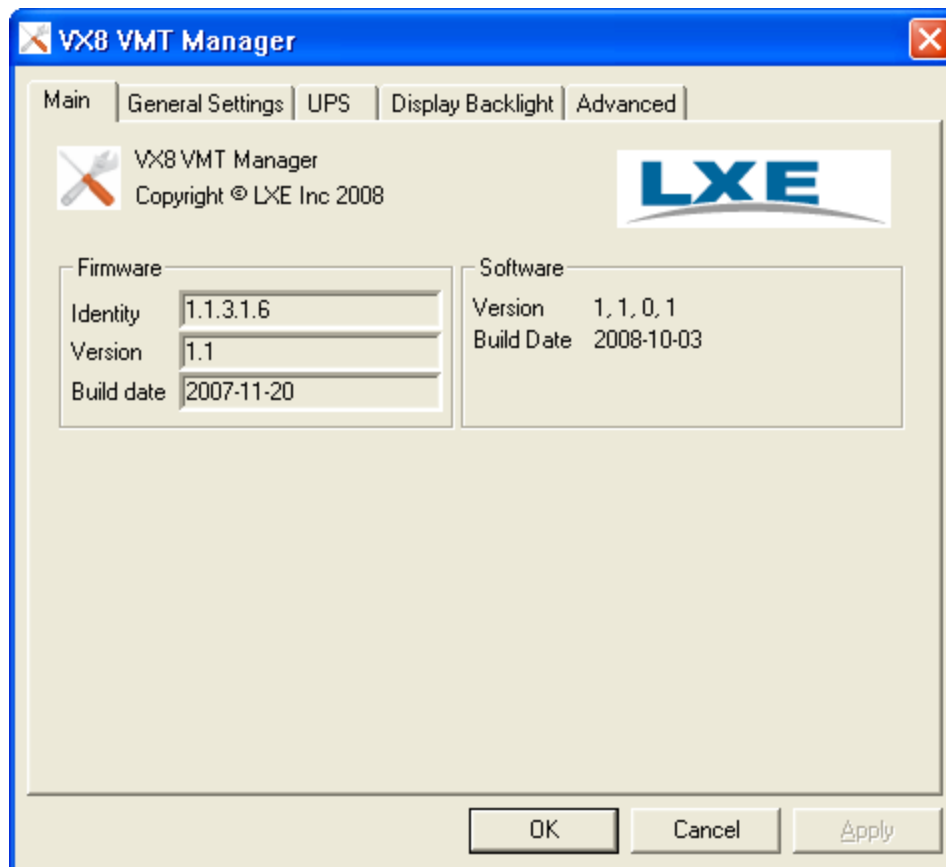

General Settings Tab

The **General Settings** tab provides configuration options for the COM1, COM2 and Multipurpose Connector ports, Startup and Shutdown options and configuration of the optional defroster.

After making any desired changes, click **Apply** to apply the new changes or **OK** to apply the changes and dismiss the VMT Manager screen.

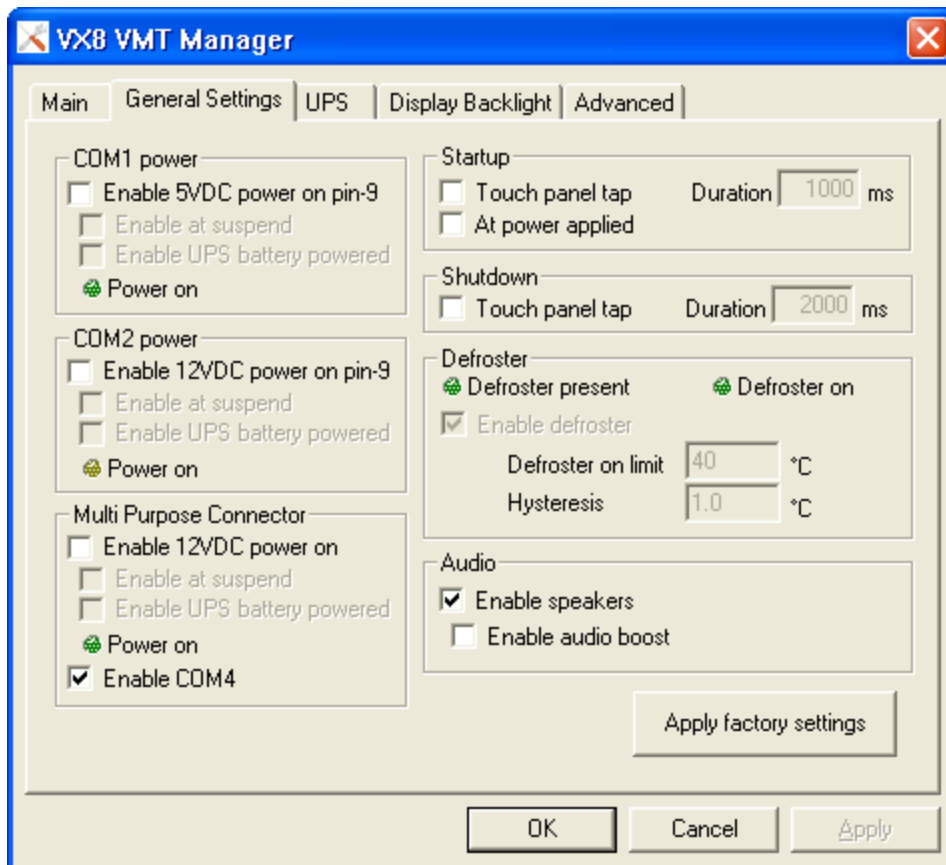

COM1 Power

Enable 5VDC power on COM1 pin 9 to power external 5V devices with a maximum power consumption of 2.5W, 500mA.

If you want the external device to be powered in suspend mode or when the Thor VX8 runs on its UPS battery, you must also select those options.

Only COM1 should be used for connecting serial bar code scanners.

COM2 Power

Enable 12VDC power on COM2 pin 9 to power external 12V devices with a maximum power consumption of 6W, 500mA. Options are the same as for COM1.

Only COM1 should be used for connecting serial bar code scanners.

Multi Purpose Connector

Enable 12VDC power on Multi Purpose Connector COM4 pin 9 to power external 12V devices. Same power consumption and options as COM2.

Only COM1 should be used for connecting serial bar code scanners.

COM4 is enabled by default but can be de-selected if necessary.

Startup

Select optional ways to power up the Thor VX8:

- by touch panel tap or
- by applying power to the Thor VX8.

These options are disabled by default. If touch panel tap is selected, you have the possibility to set the tap duration before Thor VX8 start time. Default value is 1 second (1000 ms).

Shutdown

Select touch panel tap as an optional way to shutdown the Thor VX8. By default, this option is disabled. When enabled, you can set the tap duration before Thor VX8 shutdown time. Default value is 2 seconds (2000 ms).

Important! When this shutdown option is selected, firmware will issue a power button event. This means that a touch panel tap performs the same function as the power button. See the Advanced tab of the Power Options Properties in Windows Control Panel for power button configuration. The default value in a Thor VX8 Windows image is shutdown.

Defroster

Enable defroster (heated touch panel). This option is only relevant if the Thor VX8 is equipped with an optional heated touch panel. The default value is defroster enabled.

The defroster will turn off when the temperature goes above 40°C inside the Thor VX8 and turn on again below 39°C (default values).

Note: Before making any changes to the default values, remember that the temperature outside the Thor VX8 is typically 20°C lower than inside.

Audio

Enable the front speakers. If a louder maximum volume is needed, Enable audio boost will increase the volume by 5 db.

Apply Factory Settings

Clicking this button resets the values on all tabs to their factory default values after the Thor VX8 has been shutdown and restarted.

UPS Tab

The **UPS** tab contains options for the UPS battery in the Thor VX8.

After making any desired changes, click **Apply** to apply the new changes or **OK** to apply the changes and dismiss the VMT Manager screen. If prompted, click **Yes** to confirm your changes.

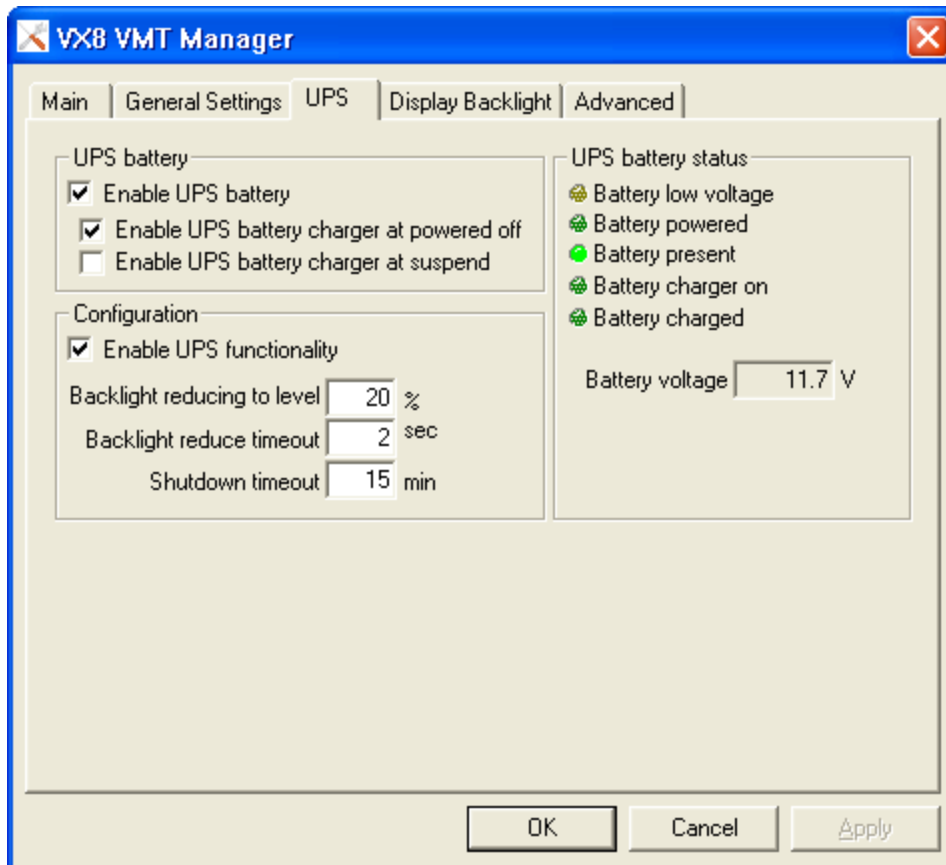

UPS Battery

Enable/disable the internal UPS battery. The UPS battery protects the Thor VX8 from being shutdown if there's a loss of input power.

Configuration

Configure how the Thor VX8 should react when/if the input power is lost by enabling UPS functionality:

- reduce backlight to a certain level after a specified timeout
- when to safely shutdown the system

UPS Battery Status

Monitor battery states and voltage.

Display Backlight Tab

The **Display Backlight** tab contains options and status for the display backlight.

After making any desired changes, click **Apply** to apply the new changes or **OK** to apply the changes and dismiss the VMT Manager screen. If prompted, click **Yes** to confirm your changes.

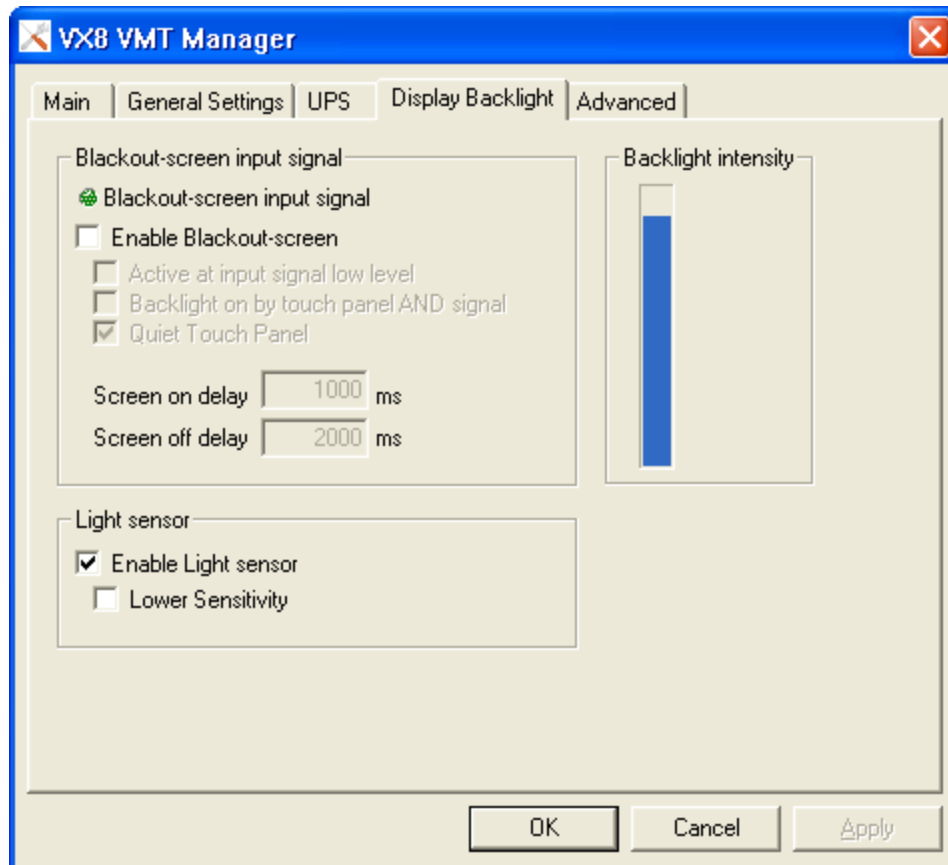

Blackout-screen Input Signal

Enable Blackout (Screen Blanking) screen functionality.

- When enabled, the backlight will turn off if there's a connection between pin 5 and 6 in the input power connector (yellow and green cable in the power cord). See [instruction for wiring](#).
- If the input signal is inverted, enable **Active at input signal low level**.
- Time delays for backlight on and off is configurable and you can also setup the backlight to come on again when the signal goes off AND the user taps the touch panel.
- The touch panel will not send any coordinates to its driver during blackout screen state if **Quiet touch panel** is enabled.

Light Sensor

Enable the light sensor on the front panel, which will automatically increase or reduce the display backlight when necessary. Enable lower sensitivity if a smoother behavior is needed.

Backlight Intensity

Monitor backlight intensity 0-100%.

Advanced Tab

The **Advanced** tab provides monitoring for several advanced functions.

There are no user configurable options on this tab.

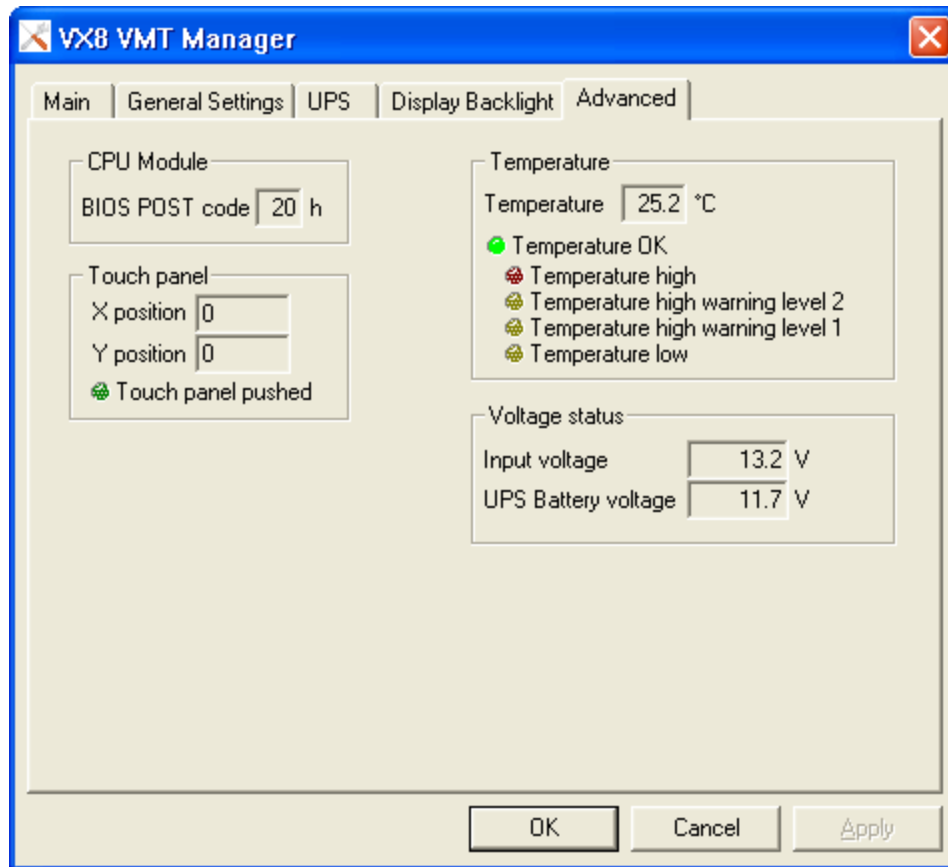

On the Advanced tab you can:

- Monitor the latest POST code sent from the CPU Module BIOS.
- Monitor driver independent touch panel functionality
- Monitor the internal temperature at carrier board level.
- Monitor input and battery power.

Wedge

The Thor VX8 computer contains a software keyboard wedge that allows scanner input to be treated as keyboard input by applications.

WLinq can create multiple profiles which can be important if more than one scanner or type of scanner may be used with the Thor VX8.

Important: If you experience trouble with processed bar code data, set the **Inter-character Delay** on the **Keyboard** tab to a value greater than 0 milliseconds.

There are many other options available in WLinq. To learn more, select **Start > All Programs > FreeFloat WLinq > Help for WLinq** or review the complete FreeFloat WLinq documentation available at FreeFloat.com.

Configuration

To configure the wedge, select **Start > All Programs > FreeFloat WLinq > WLinq**.

Click on the **Settings** button to configure WLinq. Make sure the **Communication** tab is selected.

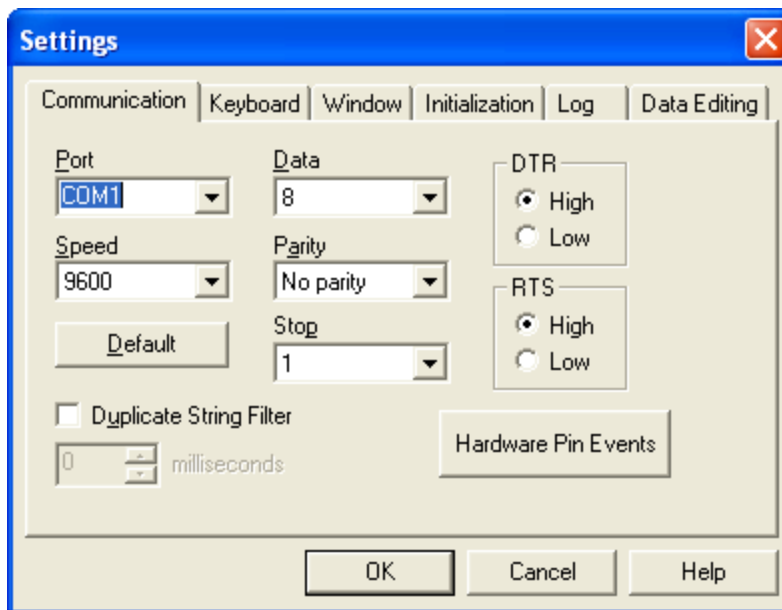

Adjust the settings on the communication tab to match the settings for the COM port to which the scanner is attached.

Next click the **Data Editing** tab.

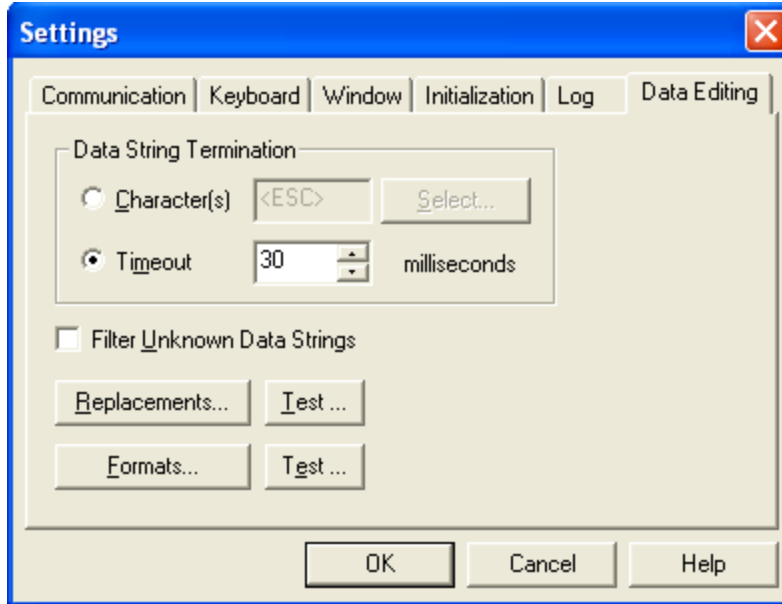

Select the proper **Data String Termination** setting:

- If the scanner is configured to end a scanned string with a termination character (for example a CR or LF) click the button for **Character(s)**. Then click the **Select..** button and choose the termination character from the list.
- If the scanner is not sending a termination character, click the button for **Timeout** and select the period in milliseconds.

Click **OK** to save settings. **Click** Hide to hide the WLinQ information screen.

When WLinQ is running, it is indicated by a gray circular icon in the task bar. The icon turns green while WLinQ is processing scanned data or red if there is an error.

To exit the WLinQ wedge, click on the taskbar icon then click the **Unload** button. To restart WLinQ, select **Start > All Programs > FreeFloat WLinQ > WLinQ** and click the Hide button.

Loading an Operating System on the Thor VX8

If it becomes necessary to reload the operating system on a Thor VX8, there are two options available.

1. A [recovery DVD](#) for the Thor VX8. The recovery DVD is customized to the type of hard drive and operating system installed in the Thor VX8.
2. A user provided operating system. The user must:
 - Provide their own installation source of a supported operating system (such as Windows XP or Windows 7)
 - Have a valid activation key for that operating system
 - Have a Thor VX8 [Drivers CD ROM](#) for the Thor VX8. This CD contains the drivers necessary to support the Thor VX8 devices when used with commercially available Microsoft Windows operating system installation media.

Contact your [representative](#) for information on the Recovery DVD and the Drivers CD.

The Thor VX8 Recovery DVD

DVD Part numbers

Thor VX8 B

VX8480WESRECOV - Windows Embedded Standard for Thor VX8 with Intel Atom CPU

VX8481WESRECOV - Windows Embedded Standard for Thor VX8 with Intel Core2Duo CPU

VX8482XPPRECOV - Windows XP Professional for Thor VX8 with Intel Atom CPU

VX8483XPPRECOV - Windows XP Professional for Thor VX8 with Intel Core2Duo CPU

VX8484W7PRECOV - Windows 7 Professional for Thor VX8 with Intel Atom CPU

VX8485W7PRECOV - Windows 7 Professional for Thor VX8 with Intel Core2Duo CPU

Thor VX8 A

VX8A476XPPRECOV – Windows XP Professional for Thor VX8 with rotating hard drive and Intel Pentium or Celeron CPU

VX8A477XPPRECOV – Windows XP Professional for Thor VX8 with flash drive and Intel Pentium or Celeron CPU

VX8A478XPERECO – Windows XP Embedded for Thor VX8 with Intel Pentium or Celeron CPU

Thor VX8 Recovery DVD

The Recovery Solution 2 (RS2) is a method to restore the software on your Thor VX8 to the same state as when it was shipped from the factory.



Backup any data that must be preserved before beginning the RS2 process. Because the RS2 process reformats the hard drive, any data or user installed programs on the Thor VX8 hard drive will be lost.

To use RS2, the following components are needed:

- A Thor VX8 configured to boot from a USB mass storage device
- A USB DVD player
- A RS2 DVD suitable for your combination of operating system, language and Thor VX8 model.

Optionally, to load the image from a network location rather than from the DVD:

- Copy the .wim file from the root directory of the RS2 DVD to a network location
- The location selected must be accessible via a wired Ethernet connection from the Thor VX8. An 802.11 WLAN connection cannot be used for the RS2 process.

Launching the RS2 Wizard

1. Attach the USB DVD player to the Thor VX8. Use a standard USB port instead of the Multi-Purpose Connector Cable on the Thor VX9.
2. Insert the RS2 DVD into the USB DVD player.
3. Start the Thor VX8.

Note: The BIOS must be configured to boot from the USB DVD player. If this is not the case please modify the boot order in the BIOS of your Thor VX8.

-
4. When the Thor VX8 boots, the BIOS may prompt you to press a key to continue to boot from the RS2 DVD. Please press a key when prompted to boot from the RS2.
 5. RS2 is now booted and the Wizard started.

Using the RS2 Wizard

1. The first screen of the Wizard displays licensing information. Review the information and click Next to accept the licensing terms.
2. The second screen of the Wizard is used to gather info on how the RS2 process is to be performed. Select the method to be used and the source location of the OS image. By default the OS image on the RS2 DVD is used. By pressing the button labeled Image File you can browse to the preferred OS image if, for instance, it has been placed on a network drive.
3. The third screen of the Wizard allows you to confirm the information before the RS2 process is started. When you click on the Next button, you are asked to confirm that you want to start the RS2 process. This is the last chance to abort RS2.
4. The fourth screen of the Wizard shows the status of the process. This process could take 30 minutes or more depending on the size of the operating system image, USB or network transfer speed, etc.
5. The last screen of the Wizard shows the result of the RS2 process.
6. When prompted, click Finish to close the Wizard and press any key to shutdown the computer.
7. Remove the RS2 media when the system has been shutdown to avoid booting up into RS2 again.
8. Your Thor VX8 has now completed the RS2 process.

The Thor VX8 Drivers CD-ROM

Driver CD Part Numbers

VX89500DRIVERS - For Thor VX8 B with Intel Atom or Core2Duo CPU

VX89A499DRIVERS - For Thor VX8 A with Intel Pentium or Celeron CPU

The Thor VX8 Drivers CD-ROM contains files that may be necessary for configuration of the Thor VX8 computer. It is recommended that the device drivers CD be available during Microsoft Windows installation and configuration. Since the Thor VX8 does not have a CD-ROM drive, the device drivers can be copied to a USB jump drive or accessed via a USB CD drive. The device drivers can also be copied to a location on the network if a network connection is used to install the Windows OS.

After Microsoft Windows is installed, device drivers contained on the CD can be used to update default Windows device drivers, if necessary.

For more information on installing or updating Microsoft Windows device drivers, please refer to Help and Support on the Windows Start menu or commercially available Windows documentation.

Startup Problems

This section lists some of the configuration error messages that may appear at system startup and their possible solutions.

Note: If you press the power switch and the Thor VX8 remains off, refer to [Power Source](#).

Problem	Solution
Thor VX8 computer stops working and locks up each time you start it.	There may be a problem with a Microsoft Windows driver. To recover from this error, follow the steps in the Bypassing Microsoft Windows Startup .
The Thor VX8 displays the “Non-System disk or disk error” message.	Make sure the Thor VX8 is booting from the proper drive. To recover from this error, follow the steps in Verifying Boot Order .
The Thor VX8 displays either “CMOS time and date not set” or “Real time clock failure” messages.	There may be a problem with the CMOS battery. Follow the steps in the Setting System Time and Date .

Bypassing Microsoft Windows Startup

When using a Microsoft Windows operating system, you may want to bypass the configuration files or load Windows with a minimum number of drivers. The Windows Start Up Menu Allows several choices that aid in diagnosing a problem. To access the start-up menu:

1. Turn on the Thor VX8.
2. Press and hold the **F5** key.
3. When the Windows Start Up Menu appears, select the desired choice from the options presented.

When you choose Safe Mode, you may notice differences in the way your system behaves. For instance, some device drivers are not loaded, the display resolution may be changed and system prompts and path have default values.

Step by step confirmation allows you to process or skip individual line items in your start up files.

Please refer to Microsoft Windows on line help or commercially available Windows guides for more information on operating Windows in safe mode and performing diagnostic and troubleshooting routines.

Verifying Boot Order

1. During bootup the **F2** or **Del** key (depending on BIOS type) key may be pressed to enter BIOS Setup. Press **F2** or **Del** immediately.
2. The BIOS Setup Main Menu is displayed. Move the highlight to the Boot Menu.
3. Verify that the desired devices are searched in the desired order.
4. For AMI BIOS, change the selection for 1st Boot Device, Second Boot Device, etc. to arrange items in the boot order.
5. For Phoenix BIOS, use the **+** (plus) key to move an item up in the boot order and the **-** (minus) key to move an item down the list. Press **SHIFT + 2nd + 1** to enable or disable a device on the search list.

If the Thor VX8 is still unable to boot from the hard drive, you may need to reformat the C: drive and restore the system from backup.

Setting System Time and Date

1. If the Thor VX8 is not already powered up, turn it on.
2. During bootup the **F2** or **Del** key (depending on BIOS type) key may be pressed to enter BIOS Setup. Press **F2** or **Del** immediately.
3. At the BIOS Setup Main Menu, move the highlight to the Time parameter.
4. Type the desired entry and then press the **Tab** key to move from hours to minutes to seconds. The colons are automatically added by the system.
5. Press the **Down Arrow** to move to the Date parameter.
6. Type the desired entry and then press the **Tab** key to move from month to day to year. The backslashes are automatically added by the system.
7. Exit BIO setup by selecting **Save Changes and Exit** or **Save and Exit**, depending on BIOS type, to save the changes. Press **Enter**.

If the Thor VX8 does not automatically reboot, turn the Thor VX8 off and then on again.

Note: The date and time may also be set using the Windows interface. Click on the time in the system tray or select Date and Time from the Windows control panel to open the Date/Time control panel.



Chapter 4: Wireless Network Configuration





Introduction

Several wireless devices may be installed in the Thor VX8 computer. The available devices and combinations may vary by regulatory domain. Available devices include:

- [An 802.11 a/b/g/n radio with Summit Client Utility \(SCU\)](#)
- [An 802.11 a/b/g radio with Atheros Client Utility \(ACU\)](#)
- [An 802.11 b/g radio with Broadcom Wireless Utility \(BWU\)](#)
- [A Bluetooth radio](#)
- [an Option® WWAN radio with GlobeTrotter® Connect software.](#)
- [a GOBI WWAN radio with OneClick Internet software.](#)

A [SIM card must be installed](#) for some WWAN carriers.

Differences in operation based on operating system type are marked with the icon shown:

-  Windows® 7 Professional
-  Windows® Embedded Standard
-  Windows® XP Embedded
-  Windows® XP Professional

For most cases, make sure Windows is NOT used to configure wireless network settings. The Summit, Atheros or Broadcom utility provides enhanced radio configuration options over the Windows utility.

If you are experiencing a Microsoft Windows networking problem, please refer to Windows on-line help or commercially available Windows networking guides for more information.

Summit Wireless Network Configuration



- Windows® 7 Professional
- Windows® Embedded Standard
- Windows® XP Professional

The Summit client device is a Summit 802.11a/b/g/n radio, capable of 802.11a, 802.11b, 802.11g and 802.11n data rates. The radio can be configured for no encryption, WEP encryption or WPA security.

Security Options Supported are

- [None](#)
- [WEP](#)
- [LEAP](#)
- [WPA-PSK](#)
- [WPA/LEAP](#)
- [PEAP-MSCHAP](#)
- [PEAP-GTC](#)
- [EAP-TLS](#)
- [EAP-FAST](#)

Important Notes

	It is important that all dates are correct on the Thor VX8 and host computers when using any type of certificate. Certificates are date sensitive and if the date is not correct authentication will fail. Verify and adjust the date using the Date and Time control panel.
	It may be necessary to upgrade radio software in order to use certain Summit Client Utility (SCU) features. Contact your representative for details.
	When using the 802.11a radio, the U-NII 1 band is the preferred band for indoor operation. For regulatory domains in which the U-NII 3 band is allowed, the following channels are supported: 149, 153, 157 and 161. The AP must be configured accordingly.

After making any changes to the wireless configuration, restart the Thor VX8.

Summit Client Utility

Note: When making changes to profile or global parameters, the device should be restarted afterwards.

Access:

Start > Programs > Summit > SCU or

SCU Icon on Desktop or

Summit Tray Icon (if present) or

Wi-Fi Icon in the Windows Control Panel (if present)

The [Main Tab](#) provides information, admin login and active profile selection.

Profile specific parameters are found on the [Profile Tab](#). The parameters on this tab can be set to unique values for each profile. This tab was labeled Config in early versions of the SCU.

The [Status Tab](#) contains information on the current connection.

The [Diags Tab](#) provides utilities to troubleshoot the radio.

Global parameters are found on the [Global Tab](#). The values for these parameters apply to all profiles. This tab was labeled Global Settings in early versions of the SCU.

Help

Help is available by clicking the ? icon in the title bar on most SCU screens.

The SCU help may also be accessed by selecting **Start > Help** and tapping the **Summit Client Utility** link. The SCU does not have to be accessed to view the help information using this option.

Summit Tray Icon





 The Summit tray icon provides access to the SCU and is a visual indicator of radio status.

The Summit tray icon is displayed when:

- The Summit radio is installed and active
- The Windows Zero Config utility is not active
- The Tray Icon setting is On
- Tray icon is not shown when the Thor VX8 is running Windows 7 or Windows Embedded Standard.

Click the icon to launch the SCU.

Use the tray icon to view the radio status:

	The radio is not currently associated or authenticated to an Access Point
	The signal strength for the currently associated/authenticated Access Point is less than -90 dBm
	The signal strength for the currently associated/authenticated Access Point is -71 dBm to -90 dBm
	The signal strength for the currently associated/authenticated Access Point is -51 dBm to -70 dBm
	The signal strength for the currently associated/authenticated Access Point is greater than -50 dBm

 *The Windows Wireless icon (located in the taskbar or Notification bar) may not display a successful wireless connection. The SCU Main tab should be used to verify the success of the connection instead.*

Wireless Zero Config Utility



Windows XP and Windows Embedded
Standard devices



Windows 7 devices

- The WZC utility has an icon in the toolbar (see above) indicating the Wireless Zero Config application is enabled but the connection is inactive at this time (the device is not connected to a network). The WZC icon may not be visible until control is passed to the WZC utility as described below.
- You can use either the Wireless Zero Configuration Utility or the Summit Client Utility to connect to your network. The Wireless Zero Configuration Utility cannot control the complete set of security features of the radio, therefore it is recommended to use the Summit Client Utility to connect to your network..

How To: Use the Wireless Zero Config Utility

1. Select **ThirdPartyConfig** in the Active Profile drop down box on the [Main tab](#).
2. A message appears that a Power Cycle is required to make settings activate properly.
3. Tap **OK**.
4. Restart the Thor VX8.

The Summit Client Utility passes control to Wireless Zero Config and the WZC Wireless Information control panel. Using the options in the Wireless Zero Config panels, set up radio and security settings. There may be a slight delay before the Wireless Zero Config icon indicates the status of the connection.

How to: Switch Control to SCU

1. To switch back to SCU control, select any other profile except **ThirdPartyConfig** in the SCU Active Config drop down list on the [Main tab](#).
2. A message appears that a Power Cycle is required to make settings activate properly.
3. Tap **OK**.
4. Restart the Thor VX8.

Radio control is passed to the SCU.

Main Tab

Start > All Programs > Summit > Summit Client Utility > Main tab

Factory Default Settings

Admin Login	SUMMIT
Radio	Enabled
Active Config/Profile	Default
Regulatory Domain	FCC, ETSI or Worldwide

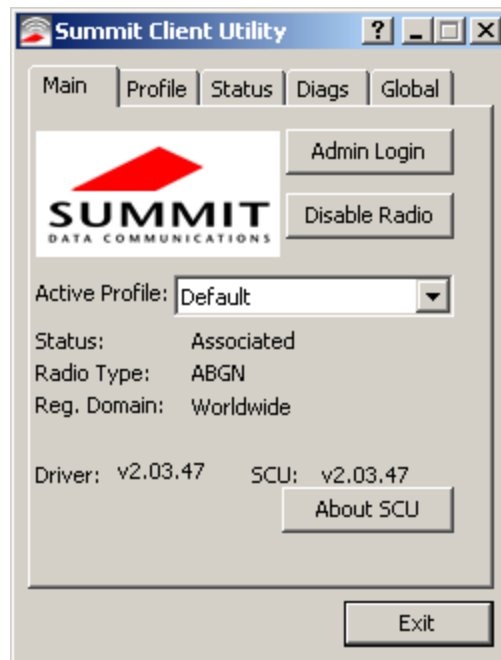

The Main tab displays information about the wireless client device including:

- SCU (Summit Client Utility) version
- Driver version
- Radio Type (ABGN is an 802.11 a/b/g/n radio).
- Regulatory Domain
- Copyright Information can be accessed by tapping the About SCU button
- Active Config profile / Active Profile name
- Status of the client (Down, Associated, Authenticated, etc.).

The **Active Profile** can be switched without logging in to Admin mode. Selecting a different profile from the drop down list does not require logging in to Administrator mode. The profile must already exist. Profiles can be created or edited after the Admin login password has been entered and accepted.

When the profile named "ThirdPartyConfig" is chosen as the active profile, the Summit Client Utility passes control to Windows Zero Config for configuration of all client and security settings for the network module.

The **Disable Radio** button can be used to disable the network card. Once disabled, the button label changes to Enable Radio. By default the radio is enabled.

The **Admin Login** button provides access to editing wireless parameters. Profile and Global may only be edited after entering the Admin Login password.

The password is case-sensitive.

Once logged in, the button label changes to Admin Logout. To logout, either tap the **Admin Logout** button or exit the SCU without tapping the **Admin Logout** button.

Admin Login

To login to Administrator mode, tap the **Admin Login** button.

Once logged in, the button label changes to Admin Logout. The admin is automatically logged out when the SCU is exited. The Admin can either tap the **Admin Logout** button, or the **OK** button to logout.

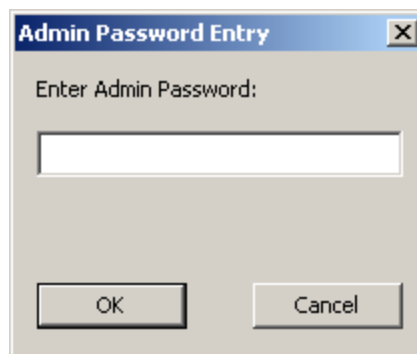

Enter the Admin password (the default password is SUMMIT and is case sensitive) and tap **OK**. If the password is incorrect, an error message is displayed.

The Administrator default password can be changed on the [Global](#) tab.

The end-user can:

- Turn the radio on or off on the Main tab.
- Select an active Profile on the Main tab.
- View the current parameter settings for the profiles on the [Profile](#) tab.
- View the global parameter settings on the [Global](#) tab.
- View the current connection details on the [Status](#) tab.
- View radio status, software versions and regulatory domain on the Main tab.
- Access additional troubleshooting features on the [Diags](#) tab.

After Admin Login, the end-user can also:

- Create, edit, rename and delete profiles on the [Profile](#) tab.
- Edit global parameters on the [Global](#) tab.
- Enable/disable the Summit tray icon in the taskbar.

Profile Tab

Start > All Programs > Summit > Summit Client Utility > Profile tab

Note: Tap the Commit button to save changes before leaving this panel or the SCU. If the panel is exited before tapping the Commit button, changes are not saved!

Factory Default Settings

Profile	Default
SSID	Blank
Client Name	Blank
Power Save	CAM
Tx Power	Maximum
Bit Rate	Auto
Radio Mode	See Profile Parameters for default
Auth Type	Open
EAP Type	None
Encryption	None

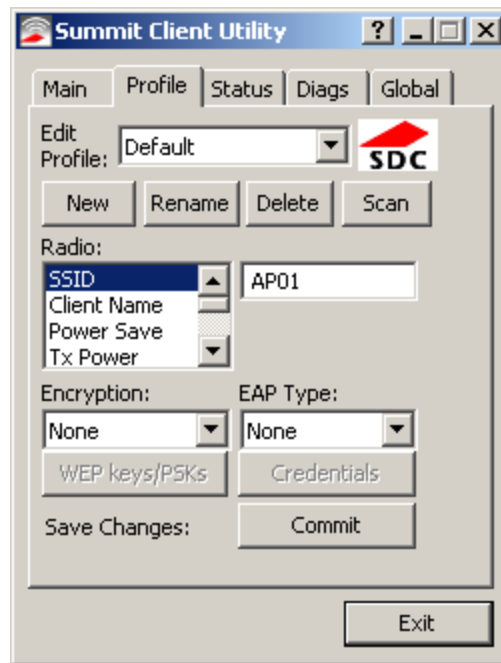

When logged in as an Admin (see [Admin Login](#)), use the Profile tab to manage profiles. When not logged in as an Admin, the parameters can be viewed, and cannot be changed. The buttons on this tab are dimmed if the user is not logged in as Admin. The Profile tab was previously labeled Config.

Buttons

Button	Function															
Commit	Saves the profile settings made on this screen. Settings are saved in the profile.															
Credentials	Allows entry of a username and password, certificate names, and other information required to authenticate with the access point. The information required depends on the EAP type.															
Delete	Deletes the profile. The current active profile cannot be deleted and an error message is displayed if a delete is attempted.															
New	Creates a new profile with the default settings (see Profile Parameters) and prompts for a unique name. If the name is not unique, an error message is displayed and the new profile is not created.															
Rename	Assigns a new, unique name. If the new name is not unique, an error message is displayed and the profile is not renamed.															
Scan	<p>Opens a window that lists access points that are broadcasting their SSIDs. Tap the Refresh button to view an updated list of APs. Each AP's SSID, its received signal strength indication (RSSI) and whether or not data encryption is in use (true or false). Sort the list by tapping on the column headers.</p> <p>If the scan finds more than one AP with the same SSID, the list displays the AP with the strongest RSSI and the least security.</p> <div data-bbox="667 934 1094 1344" data-label="Image"> <table border="1"> <thead> <tr> <th>SSID</th> <th>R...</th> <th>Se...</th> </tr> </thead> <tbody> <tr> <td>Net4</td> <td>-47</td> <td>true</td> </tr> <tr> <td>Net2</td> <td>-48</td> <td>true</td> </tr> <tr> <td>Net1</td> <td>-51</td> <td>true</td> </tr> <tr> <td>Net3</td> <td>-51</td> <td>false</td> </tr> </tbody> </table> <p>The image shows a window titled 'Scan' with a close button (X) in the top right corner. Below the title bar is a table with three columns: 'SSID', 'R...' (RSSI), and 'Se...' (Security). The table contains four rows of data: Net4 (RSSI: -47, Security: true), Net2 (RSSI: -48, Security: true), Net1 (RSSI: -51, Security: true), and Net3 (RSSI: -51, Security: false). At the bottom of the window are two buttons: 'Configure' and 'Refresh'.</p> </div> <p>If you are logged in as an Admin, tap an SSID in the list and tap the Configure button, you return to the Profile window to recreate a profile for that SSID, with the profile name being the same as the SSID (or the SSID with a suffix such as “_1” if a profile with the SSID as its name exists already).</p>	SSID	R...	Se...	Net4	-47	true	Net2	-48	true	Net1	-51	true	Net3	-51	false
SSID	R...	Se...														
Net4	-47	true														
Net2	-48	true														
Net1	-51	true														
Net3	-51	false														
WEP Keys / PSK Keys	Allows entry of WEP keys or pass phrase as required by the type of encryption.															

Note: Unsaved Changes – The SCU will display a reminder if the Commit button is not clicked before an attempt is made to close or browse away from this tab.

Important – The settings for Auth Type, EAP Type and Encryption depend on the security type chosen.

Profile Parameters

Parameter	Default	Explanation
Edit Profile	Default	A string of 1 to 32 alphanumeric characters, establishes the name of the Profile. Options are Default or ThirdPartyConfig.
SSID	Blank	A string of up to 32 alphanumeric characters. Establishes the Service Set Identifier (SSID) of the WLAN to which the client connects.
Client Name	Blank	A string of up to 16 characters. The client name is assigned to the network card and the device using the network card. The client name may be passed to networking wireless devices, e.g. Access Points.
Power Save	CAM	Power save mode is On. Options are: Constantly Awake Mode (CAM) power save off, Maximum (power saving mode) and Fast (power saving mode).
Tx Power	Maximum	Maximum setting regulates Tx power to the Max power setting for the current regulatory domain. Options are: Maximum, 50mW, 30mW, 20mW, 10mW, 5mW, or 1mW.
Bit Rate	Auto	Setting the rate to Auto will allow the Access Point to automatically negotiate the bit rate with the client device. Options are: Auto, 1 Mbit, 2, 5.5, 6, 9, 11, 12, 18, 24, 36, 48 or 54 Mbit.
Auth Type	Open	802.11 authentication type used when associating with the Access Point. Options are: Open, LEAP, or Shared key.
EAP Type	None	Extensible Authentication Protocol (EAP) type used for 802.1x authentication to the Access Point. Options are: None, LEAP, EAP-FAST, PEAP-MSCHAP, PEAP-GTC, EAP-TTLS, PEAP-TLS, or EAP-TLS. <i>Note: EAP Type chosen determines whether the Credentials button is active and also determines the available entries in the Credentials pop-up window.</i>
Encryption	None	Type of encryption to be used to protect transmitted data. Available options may vary by SCU version. Options are: None, WEP (or Manual WEP), WEP EAP (or Auto WEP), WPA PSK, WPA TKIP, WPA CCKM, WPA2 PSK, WPA2 AES, or WPA2 CCKM. CKIP is not supported in the Thor VX8. <i>Note: The Encryption type chosen determines if the WEP Keys / PSK Keys button is active and also determines the available entries in the WEP or PSK pop-up window.</i>

Parameter	Default	Explanation
Radio Mode	BGA Rates Full	<p>Specify 802.11a, 802.11b and/or 802.11g rates when communicating with the AP. The options displayed for this parameter depend on the type of radio installed in the mobile device.</p> <p>Options:</p> <ul style="list-style-type: none"> B rates only (1, 2, 5.5 and 11 Mbps) BG Rates Full (All B and G rates) G rates only (6, 9, 12, 18, 24, 36, 48 and 54 Mbps) BG optimized or BG subset (1, 2, 5.5, 6, 11, 24, 36 and 54 Mbps) A rates only (6, 9, 12, 18, 24, 36, 48 and 54 Mbps) ABG Rates Full (All A rates and all B and G rates with A rates preferred) BGA Rates Full (All B and G rates and all A rates with B and G rates preferred) Ad Hoc (when connecting to another client device instead of an AP) <p>Default:</p> <p>BGA Rates Full (for 802.11a/b/g/n radio)</p>

It is important the **Radio Mode** parameter correspond to the AP to which the device is to connect. For example, if this parameter is set to G rates only, the Thor VX8 may only connect to APs set for G rates and not those set for B and G rates. Contact your [representative](#) if you have questions about the antenna(s) installed on your Thor VX8.

Status Tab

Start > All Programs > Summit > Summit Client Utility > Status tab

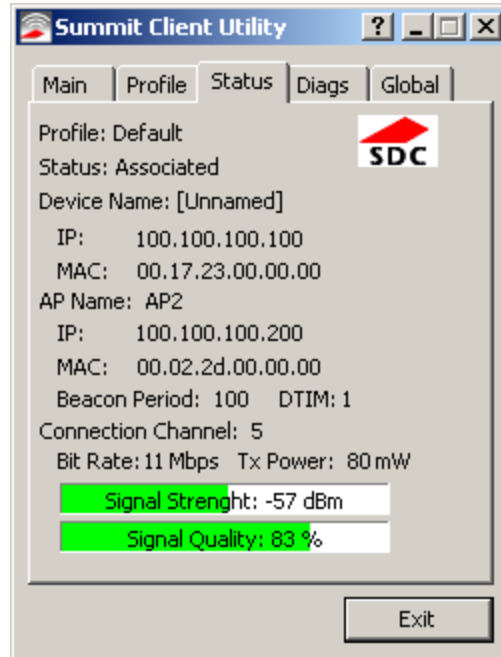

This screen provides information on the radio:

- The profile being used
- The status of the radio card (down, associated, authenticated, etc.)
- Client information including device name, IP address and MAC address.
- Information about the Access Point (AP) maintaining the connection to the network including AP name, IP address and MAC address.
- Channel currently being used for wireless traffic
- Bit rate in Mbit.
- Current transmit power in mW
- Beacon period – the time between AP beacons in kilomicroseconds. (one kilomicrosecond = 1,024 microseconds)
- DTIM interval – A multiple of the beacon period that specifies how often the beacon contains a delivery traffic indication message (DTIM). The DTIM tells power saving devices a packet is waiting for them. For example, if DTIM = 3, then every third beacon contains a DTIM.
- Signal strength (RSSI) displayed in dBm and graphically
- Signal quality, a measure of the clarity of the signal displayed in percentage and graphically.

There are no user entries on this screen.

Note: After completing radio configuration, it is a good idea to review this screen to verify the radio has associated (no encryption, WEP) or authenticated (LEAP, any WPA), as indicated above.

Diags Tab

Start > All Programs > Summit > Summit Client Utility > Diags tab

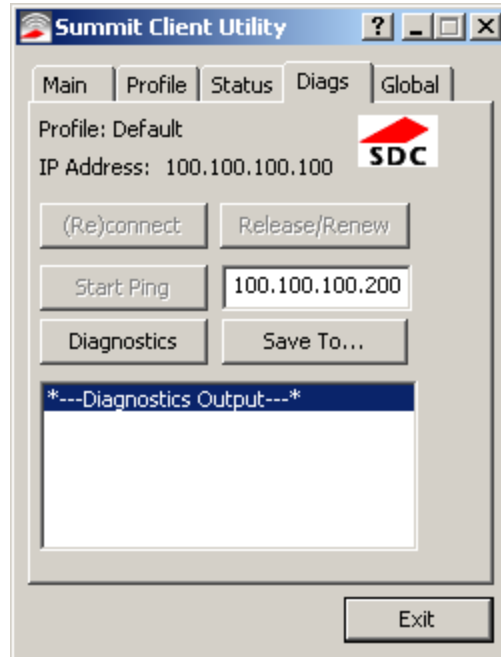

The Diags screen can be used for troubleshooting network traffic and radio connectivity issues.

- **(Re)connect** – Use this button to apply (or reapply) the current profile and attempt to associate or authenticate to the wireless LAN. All activity is logged in the Diagnostic Output box on the lower part of the screen.
- **Release/Renew** – Obtain a new IP address through release and renew. All activity is logged in the Diagnostic Output box. If a fixed IP address has been assigned to the radio, this is also noted in the Diagnostic Output box. Note that the current IP address is displayed above this button.
- **Start Ping** – Start a continuous ping to the IP address specified in the text box to the right of this button. Once the button is clicked, the ping begins and the button label changes to **Stop Ping**. Clicking the button ends the ping. The ping also ends when any other button on this screen is clicked or the user browses away from the Diags tab. The results of the ping are displayed in the Diagnostic Output box.
- **Diagnostics** – Also attempts to (re)connect to the wireless LAN. However, this option provides more data in the Diagnostic Output box than the (Re)connect option. This data dump includes radio state, profile settings, global settings, and a list of broadcast SSID APs.
- **Save To...** – Use this to save the results of the diagnostics to a text file. Use the explorer window to specify the name and location for the diagnostic file. The text file can viewed using an application such as WordPad.

Global Tab

Start > All Programs > Summit > Summit Client Utility > Global tab

The parameters on this panel can only be changed when an [Admin is logged in](#) with a password. The current values for the parameters can be viewed by the general user without requiring a password.

Note: Tap the Commit button to save changes. If the panel is exited before tapping the Commit button, changes are not saved!

Factory Default Settings

Roam Trigger	-65 dBm
Roam Delta	5 dBm
Roam Period	10 sec.
BG Channel Set	Full
DFS Channels	Off
DFS Scan Time	120 ms.
Ad Hoc Channel	1
Aggressive Scan	On
CCX	Optimized
WMM	<input checked="" type="checkbox"/> On <input type="checkbox"/> Off
Auth Server	Type 1
TTLS Inner Method	Auto-EAP
PMK Caching	Standard
WAPI	Off (dimmed)
TX Diversity	On
RX Diversity	On Start on Main
Frag Threshold	2346
RTS Threshold	2347
LED	Off
Tray Icon	On
Hide Passwords	On
Admin Password	SUMMIT (or blank)
Auth Timeout	8 seconds
Certs Path	C:\Program Files\Summit\certs
Ping Payload	32 bytes
Ping Timeout	5000 ms

Ping Delay ms	1000 ms
Logon Options	Use SCU credentials

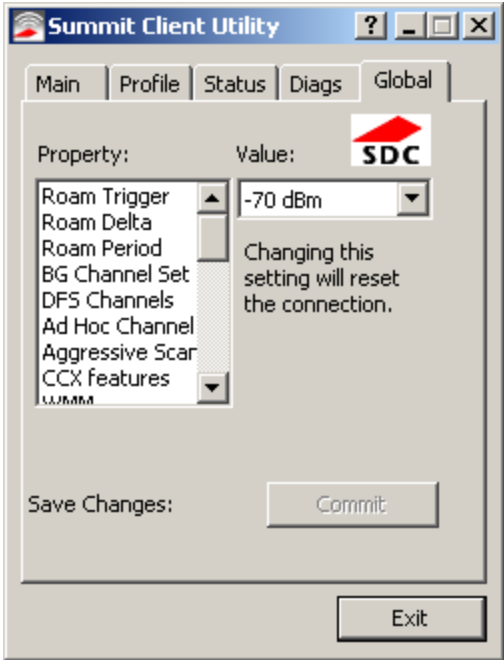

Custom Parameter Option

Honeywell does not support the parameter Custom option. The parameter value is displayed as “Custom” when the operating system registry has been edited to set the Summit parameter to a value that is not available from the parameter’s drop down list. Selecting Custom from the drop down list has no effect. Selecting any other value from the drop down list will overwrite the “custom” value in the registry.

Global Parameters

Parameter	Default	Function
Roam Trigger	-65 dBm	If signal strength is less than this trigger value, the client looks for a different Access Point with a stronger signal. Options are: -50 dBm, -55, -60, -65, -70, -75, -80, -85, -90 dBm or Custom .
Roam Delta	5 dBm	The amount by which a different Access Point signal strength must exceed the current Access Point signal strength before roaming to the different Access Point is attempted. Options are: 5 dBm, 10, 15, 20, 25, 30, 35 dBm or Custom .
Roam Period	10 sec.	The amount of time, after association or a roam scan with no roam, that the radio collects Received Signal Strength Indication (RSSI) scan data before a roaming decision is made. Options are: 5 sec, 10, 15, 20, 25, 30, 35, 40, 45, 50, 55, 60 seconds or Custom .
BG Channel Set	Full	Defines the 2.4GHz channels to be scanned for an AP when the radio is contemplating roaming. By specifying the channels to search, roaming time may be reduced over scanning all channels. Options are: Full (all channels) 1,6,11 (the most commonly used channels) 1,7,13 (for ETSI and TELEC radios only) Custom .
DFS Channels	Off	Support for 5GHZ 802.11a channels where support for DFS is required. Options are: On, Off, Optimized. <i>Note: Not supported (always off) in some releases.</i>
DFS Scan Time	120 ms.	ABG radio only. The amount of time the radio will passively scan each DFS channel to see if it will receive a beacon. Recommended value is 1.5 times that of the AP's beacon period.
Ad Hoc Channel	1	Use this parameter when the Radio Mode profile parameter is set to Ad Hoc. Specifies the channel to be used for an Ad Hoc connection to another client device. If a channel is selected that is not supported by the by the radio, the default value is used. Options are: 1 through 14 (the 2.4GHz channels) 36, 40, 44, 48 (the UNII-1 channels)
Aggressive Scan	On	When set to On and the current connection to an AP weakens, the radio aggressively scans for available APs. Aggressive scanning works with standard scanning (set through Roam Trigger, Roam Delta and Roam Period). Aggressive scanning should be set to On unless there is significant co-channel interference due to overlapping APs on the same channel.

Parameter	Default	Function
		Options are: On, Off
CCX or CCX Features	Optimized	Use of Cisco Compatible Extensions (CCX) radio management and AP specified maximum transmit power features. Options are: Full - Use Cisco IE and CCX version number, support all CCX features. The option known as "On" in previous versions. Optimized –Use Cisco IE and CCX version number, support all CCX features except AP assisted roaming, AP specified maximum transmit power and radio management. Off - Do not use Cisco IE and CCX version number. Cisco IE = Cisco Information Element.
WMM	<input checked="" type="checkbox"/> On <input type="checkbox"/> Off	Use of Wi-Fi Multimedia extensions. Devices running Windows XP can change the default value. Devices running all other OS cannot change the default value.
Auth Server	Type 1	Specifies the type of authentication server. Options are: Type 1 (ACS server) and Type 2 (non-ACS server)
TTLS Inner Method	Auto-EAP	Authentication method used within the secure tunnel created by EAP-TTLS. Options are: AUTO-EAP (Any available EAP method), MSCHAPV2, MSCHAP, PAP, CHAP, EAP-MSCHAPV2.
PMK Caching	Standard	Type of Pairwise Master Key (PMK) caching to use when WPA2 is in use. PMK caching is designed to speed up roaming between APs by allowing the client and the AP to cache the results of 802.1X authentications, eliminating the need to communicate with the ACS server. Standard PMK is used when there are no controllers. The reauthentication information is cached on the original AP. The client and the AP use the cached information to perform the four-way handshake to exchange keys. Opportunistic PMK (OPMK) is used when there are controllers. The reauthentication information cached on the controllers. The client and the controller behind the AP use the cached information to perform the four-way handshake to exchange keys. If the selected PMK caching method is not supported by the network infrastructure, every roam requires full 802.11X authentication, including interaction with the ACS server. If the active profile is using WPA2 CCKM, the global PMK Caching setting is ignored and the client attempts to use CCKM. Options are: Standard, OPMK
WAPI	Off	Default is Off and dimmed (cannot be changed).
TX Diversity	On	How to handle antenna diversity when transmitting packets to the Access Point. Options are: Main only, and On.

Parameter	Default	Function
RX Diversity	On Start on Main	How to handle antenna diversity when receiving packets from the Access Point. Option is: On-start on Main <i>Note: This parameter cannot be changed for some Summit radios.</i>
Frag Thresh	2346	If the packet size (in bytes) exceeds the specified number of bytes set in the fragment threshold, the packet is fragmented (sent as several pieces instead of as one block). Use a low setting in areas where communication is poor or where there is a great deal of wireless interference. Options are: Any number between 256 bytes and 2346 bytes.
RTS Thresh	2347	If the packet size exceeds the specified number of bytes set in the Request to Send (RTS) threshold, an RTS is sent before sending the packet. A low RTS threshold setting can be useful in areas where many client devices are associating with the Access Point. This parameter cannot be changed.
LED	Off	The LED on the wireless card is not visible to the user when the wireless card is installed in a sealed mobile device. Options are: On, Off.
Tray Icon	On	Determines if the Summit icon is displayed in the System tray. Options are: On, Off <i>The tray icon is not displayed when the Thor VX8 is running a Windows Embedded Standard or Windows 7 Professional operating system.</i>
Hide Password	On	When On, the Summit Config Utility masks passwords (characters on the screen are displayed as an *) as they are typed and when they are viewed. When Off, password characters are not masked. Options are: On, Off.
Admin Password	SUMMIT (or Blank)	A string of up to 64 alphanumeric characters that must be entered when the Admin Login button is tapped. If Hide Password is On, the password is masked when typed in the Admin Password Entry dialog box. The password is case sensitive. This value is masked when the Admin is logged out. Options are: none.
Auth Timeout	8 seconds	Specifies the number of seconds the Summit software waits for an EAP authentication request to succeed or fail. If the authentication credentials are stored in the active profile and the authentication times out, the association fails. No error message or prompting for corrected credentials is displayed. If the authentication credentials are not stored in the active profile and the authentication times out, the user is again prompted to enter the credentials. Options are: An integer from 3 to 60.
Certs Path	certificates	A valid directory path, of up to 64 characters, where WPA Certificate Authority and User Certificates are stored on the mobile device when not using the Windows certificates store. Ensure the Windows folder path currently exists before assigning the path in this parameter. See Certificates

Parameter	Default	Function
		for instructions on obtaining CA and User Certificates. This value is masked when the Admin is logged out. Options are: none. The complete path is C:\Program Files\Summit\certs
Ping Payload	32 bytes	Maximum amount of data to be transmitted on a ping. Options are: 32 bytes, 64, 128, 256, 512, or 1024 bytes.
Ping Timeout ms	5000	The amount of time, in milliseconds, that a device will be continuously pinged. The Stop Ping button can be tapped to end the ping process ahead of the ping timeout. Options are: Any number between 0 and 30000 ms.
Ping Delay ms	1000	The amount of time, in milliseconds, between each ping after a Start Ping button tap. Options are: Any number between 0 and 30000 ms.
Logon Options	SCU	Use SCU or Windows login credentials. More info.

Note: Tap the Commit button to save changes. If this panel is closed before tapping the Commit button, changes are not saved!

Logon Options

There are two options available, a [single signon](#) which uses the Windows username and password as the credentials for 802.1x authentication and [pre-logon](#) which used saved credentials for 802.1x authentication before Windows logon.

If either option is enabled, the credentials entered here take precedence over any credentials entered on the [Profile](#) tab.

To use either option, select **Logon Options**. The Logon Options button is displayed.

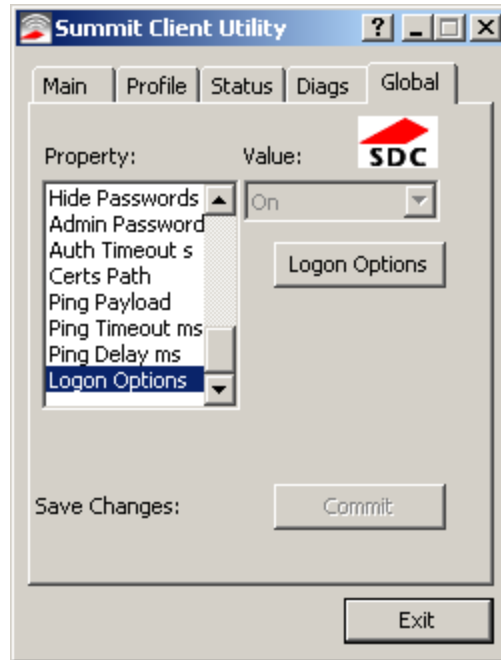

Click the **Logon Options** button.

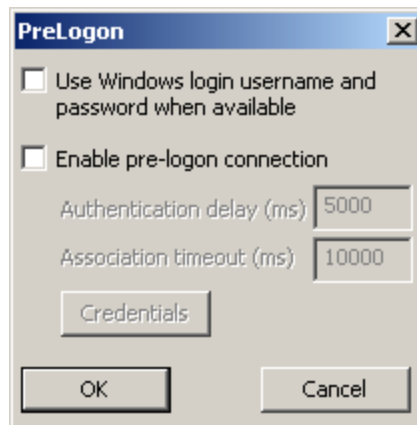

Single Signon

To use the Single Signon option, select the checkbox for **Use the Windows username and password when available**. When the active profile is using LEAP, PEAP-MSCHAP, PEAP-GTC or EAP-FAST, the SCU ignores the username and password, if any, saved in the profile. Instead, the username and password used for Windows logon is used. Any certificates needed for authentication must still be specified in the profile.

Click **OK** then click **Commit**.

Pre-Logon Connection

To use the Pre-logon connection, select the checkbox for Enable pre-logon connection. This option is designed to be used when:

- EAP authentication is required for a WLAN connection
- Single Signon is configured, so the Windows username and password are used as credentials for EAP authentication
- The WLAN connection needs to be established before the Windows login.

Once this option is enabled, the **Authentication delay** and **Association timeout** values can be adjusted as necessary. Both values are specified in milliseconds (ms).

The default authentication delay is 5000 ms and the valid range is 0 - 600,000 ms.

The default association timeout is 10,000 ms and the valid range is 10,000 to 600,000 ms.

Click on the **Credentials** button to enter the logon credentials.

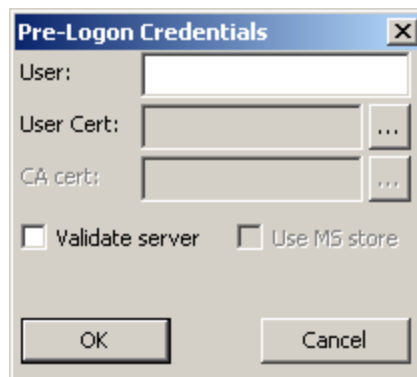

If using the Windows certificate store:

- Check the **Use MS store** checkbox. The default is to use the Full Trusted Store.
- To select an individual certificate, click on the **Browse** button.
- Uncheck the **Use full trusted store** checkbox.
- Select the desired certificate and click **Select**. You are returned to the Credentials screen.

If using the Certs Path option:

- Leave the Use MS store box unchecked.
- Enter the certificate filename in the CA Cert textbox.

Click **OK** then click **Commit**.

Sign-On vs. Stored Credentials

When using wireless security that requires a user name and password to be entered, the Summit Client Utility offers these choices:

- The Username and Password may be entered on the Credentials screen. If this method is selected, anyone using the device can access the network.
- The Username and Password are left blank on the Credentials screen. When the device attempts to connect to the network, a sign on screen is displayed. The user must enter the Username and Password at that time to authenticate.
- When using Summit with the Thor VX8, there is an option on the [Global](#) tab to use the Windows user name and password to log on instead of any username and password stored in the profile.

How to: Use Stored Credentials

	<p>Credentials login and password entry window: When the Thor VX8 attempts to connect to the network, click the flashing icon in the Notification bar to display the login screen. Enter user name and password and click OK to close the window. This procedure will need to be followed each time the Thor VX8 returns from, for example:</p> <ul style="list-style-type: none">• sleep,• hibernate,• restart,• change in profiles, and• when invalid credentials have been entered.
---	---

1. After completing the other entries in the profile, click on the **Credentials** button.
2. Enter the Username and Password on the Credentials screen and click the **OK** button.
3. Click the **Commit** button.
4. For LEAP and WPA/LEAP, configuration is complete.
5. For PEAP-MSCHAP and PEAP-GTC, importing the CA certificate into the Windows certificate store is optional.
6. For EAP-TLS, import the CA certificate into the Windows certificate store. Also import the User Certificate into the Windows certificate store.
7. Access the Credentials screen again. Make sure the **Validate server** and **Use MS store** checkboxes are checked.
8. The default is to use the entire certificate store for the CA certificate. Alternatively, use the **Browse** button next to the CA Cert (CA Certificate Filename) on the Credentials screen to select an individual certificate.
9. For EAP-TLS, also enter the User Cert (User Certificate filename) on the credentials screen by using the **Browse** button.
10. If using EAP FAST and manual PAC provisioning, input the PAC filename and password..
11. Click the **OK** button then the **Commit** button.
12. If changes are made to the stored credentials, click **Commit** to save those changes before making any additional changes to the profile or global parameters.
13. Verify the device is authenticated by reviewing the Status tab. When the device is property configured, the Status tab indicates the device is Authenticated and the method used.

Note: See [Configuring the Profile](#) for more details.

Note: If invalid credentials are entered into the stored credentials, the authentication will fail. No error message is displayed. The user may or may not be prompted to enter valid credentials.

How to: Use Sign On Screen

1. After completing the other entries in the profile, click on the **Credentials** button. Leave the Username and Password blank. No entries are necessary on the Credentials screen for LEAP or LEAP/WPA.
2. For PEAP-MSCHAP and PEAP-GTC, importing the CA certificate into the Windows certificate store is optional.
3. For EAP-TLS, import the CA certificate into the Windows certificate store. Also import the User Certificate into the Windows certificate store.
4. Access the Credentials screen again. Make sure the **Validate server** and **Use MS store** checkboxes are checked.
5. The default is to use the entire certificate store for the CA certificate. Alternatively, use the Browse button next to the CA Cert (CA Certificate Filename) on the Credentials screen to select an individual certificate.
6. For EAP-TLS, also enter the User Cert (User Certificate filename) on the credentials screen by using the **Browse** button.
7. Click the **OK** button then the **Commit** button.
8. When the device attempts to connect to the network, a sign-on screen is displayed.
9. Enter the Username and Password. Click the **OK** button.

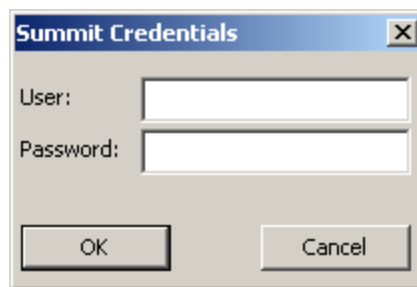

10. Verify the device is authenticated by reviewing the Status tab. When the device is properly configured, the [Status Tab](#) indicates the device is Authenticated and the method used.
11. The sign-on screen is displayed after a reboot.

Note: See [Configuring the Profile](#) for more details.

If a user enters invalid credentials and clicks **OK**, the device associates but does not authenticate. The user is again prompted to enter credentials.

If the user clicks the **Cancel** button, the device does not associate. The user is not prompted again for credentials until:

- the device is rebooted,
- the radio is disabled then enabled,
- the **Reconnect** button on the [Diags Tab](#) is clicked or
- the profile is modified and the **Commit** button is clicked.

How to: Use Windows Username and Password

Please see [Logon Options](#) for information.

Windows Certificate Store vs. Certs Path

Note: It is important that all dates are correct on the Thor VX8 and host computers when using any type of certificate. Certificates are date sensitive and if the date is not correct authentication will fail.



If using the Windows Certificate Store, the Windows Account must have a password. The password cannot be left blank. The Summit Client Utility uses the Windows user account credentials to access the Certificate Store. The Windows user account credentials need not be the same as the [wireless credentials](#) entered in the Summit Client Utility.

User Certificates

EAP-TLS authentication requires a user certificate. The user certificate must be stored in the Windows certificate store.

- To generate the user certificate, see [Generating a User Certificate](#).
- To import the user certificate into the Windows certificate store, see [Installing a User Certificate](#).
- A Root CA certificate is also needed. Refer to the section below.

Root CA Certificates

Root CA certificates are required for EAP/TLS, PEAP/GTC and PEAP/MSCHAP. Two options are offered for storing these certificates. They may be imported into the Windows certificate store or copied into the Certs Path directory.

How To: Use the Certs Path

1. See [Generating a Root CA Certificate](#) and follow the instructions to download the Root Certificate to a PC.
2. Copy the certificate to specified directory on the mobile device. The default location for Certs Path is C:\Program Files\Summit\certs. A different location may be specified by using the Certs Path global variable.
3. When completing the Credentials screen for the desired authentication, do not check the **Use MS store** checkbox after checking the **Validate server** checkbox.
4. Enter the certificate name in the CA Cert textbox.
5. Click **OK** to exit the Credentials screen and then **Commit** to save the profile changes.

How To: Use Windows Certificate Store

1. See [Generating a Root CA Certificate](#) and follow the instructions to download the Root Certificate to a PC.
2. To import the certificate into the Windows store, See [Installing a Root CA Certificate](#).
3. When completing the Credentials screen for the desired authentication, be sure to check the **Use MS store** checkbox after checking the **Validate server** checkbox.
4. The default is to use all certificates in the store. If this is OK, skip to the last step.
5. Otherwise, to select a specific certificate click on the **Browse (...)** button.

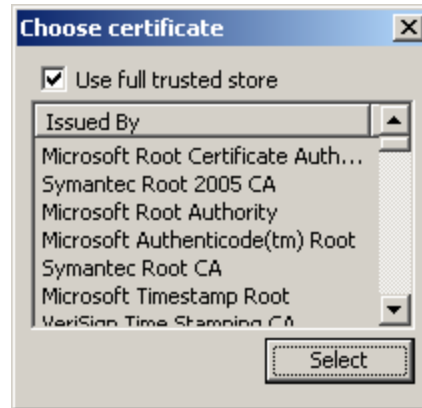

6. Uncheck the **Use full trusted store** checkbox.
7. Select the desired certificate and click the **Select** button to return the selected certificate to the CA Cert textbox.
8. Click **OK** to exit the Credentials screen and then **Commit** to save the profile changes.

Configuring the Profile

Use the instructions in this section to complete the entries on the Profile tab according to the type of wireless security used by your network. The instructions that follow are the minimum required to successfully connect to a network. Your system may require more parameters than are listed in these instructions. Please see your system administrator for complete information about your network and its wireless security requirements.

To begin the configuration process:

- On the [Main Tab](#), click the [Admin Login](#) button and enter the password.
- Unless you need to create multiple profiles, edit the default profile with the parameters for your network. Select the Default profile from the pull down menu.
- Make any desired parameter changes as described in the applicable following section determined by network security type and click the **Commit** button to save the changes.

IMPORTANT – Remember to click the Commit button after making changes to ensure the changes are saved. Many versions of the SCU display a reminder if the Commit button is not clicked before an attempt is made to close or browse away from the tab in focus if there are unsaved changes.

If changes are made to the *stored credentials*, click Commit to save those changes first before making any additional changes.

No Security

To connect to a wireless network with no security, make sure the following profile options are used.

- Enter the **SSID** of the Access Point assigned to this profile
- Set **EAP Type** to **None**
- Set **Encryption** to **None**
- Set **Auth Type** to **Open**

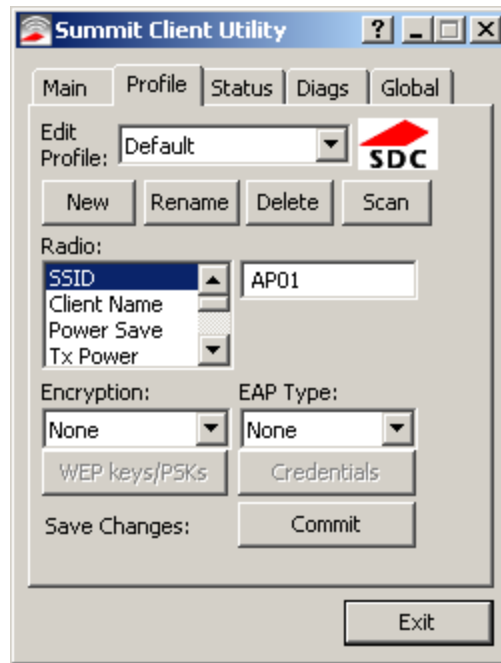

Once configured, click the **Commit** button.

Ensure the correct Active Profile is selected on the [Main tab](#) and restart. The SCU Main tab shows the device is associated after the radio connects to the network.

WEP

To connect using WEP, make sure the following profile options are used.

- Enter the **SSID** of the Access Point assigned to this profile
- Set **EAP Type** to **None**
- Set **Encryption** to **WEP** or **Manual WEP** (depending on SCU version)
- Set **Auth Type** to **Open**

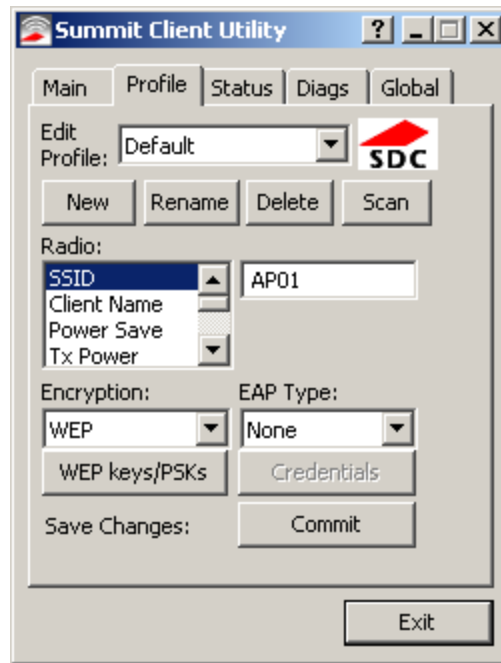

Click the **WEP keys/PSKs** button.



The image shows a dialog box titled "WEP Key Entry" with a close button (X) in the top right corner. The text inside the dialog reads: "Enter 10 or 26 Hex digits (A-F, 0-9) OR enter 5 or 13 ASCII characters." Below this text is the label "Tx Key" followed by four radio button options: "1", "2", "3", and "4". Each radio button is followed by a text input field. The "1" radio button is selected. At the bottom of the dialog are two buttons: "OK" and "Cancel".

Valid keys are 10 hexadecimal or 5 ASCII characters (for 40-bit encryption) or 26 hexadecimal or 13 ASCII characters (for 128-bit encryption). Enter the key(s) and click **OK**.

Once configured, click the **Commit** button.

Ensure the correct Active Profile is selected on the [Main tab](#) and restart. The SCU Main tab shows the device is associated after the radio connects to the network.

LEAP

To use LEAP (without WPA), make sure the following profile options are used.

- Enter the **SSID** of the Access Point assigned to this profile
- Set **EAP Type** to **LEAP**
- Set **Encryption** to **WEP EAP** or **Auto WEP** (depending on SCU version)
- Set **Auth Type** as follows:
 - If the Cisco/CCX certified AP is configured for open authentication, set the **Auth Type** radio parameter to **Open**.
 - If the AP is configured to use shared key or passphrase, set the Auth Type radio parameter to **Shared**.
 - If the AP is configured for network EAP only, set the **Auth Type** radio parameter to **LEAP**.

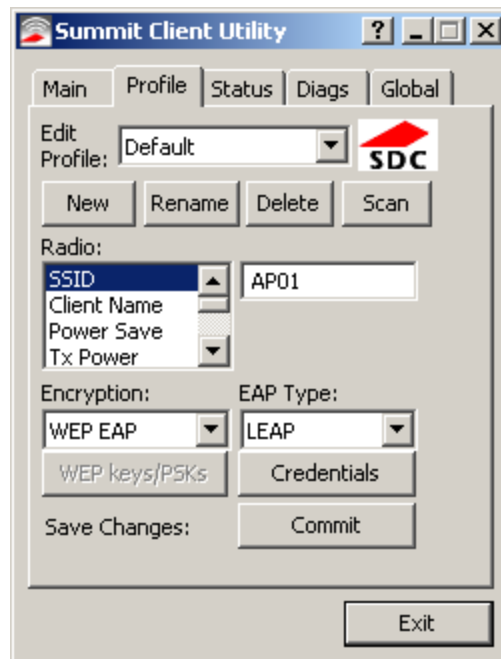

See [Sign-On vs. Stored Credentials](#) for information on entering credentials.

To use Stored Credentials, click on the **Credentials** button. No entries are necessary for Sign-On Credentials as the user will be prompted for the Username and Password when connecting to the network.

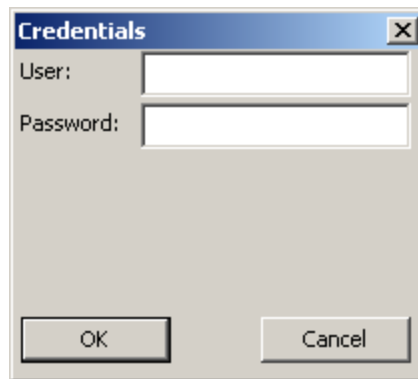
A screenshot of a Windows-style dialog box titled "Credentials". The dialog has a blue title bar with a close button (X) in the top right corner. Inside the dialog, there are two text input fields. The first is labeled "User:" and the second is labeled "Password:". Below the input fields, there are two buttons: "OK" on the left and "Cancel" on the right. The background of the dialog is a light gray color.

Enter the Domain\Username (if the Domain is required), otherwise enter the Username.

Enter the password. Click **OK** then click the **Commit** button.

Ensure the correct Active Profile is selected on the [Main tab](#) and restart. The SCU Main tab shows the device is associated after the radio connects to the network.

PEAP/MSCHAP

To use PEAP/MSCHAP, make sure the following profile options are used.

- Enter the **SSID** of the Access Point assigned to this profile
- Set **EAP Type** to **PEAP-MSCHAP**
- Set **Encryption** to **WPA TKIP**
- Set **Auth Type** to **Open**

To use another encryption type, select WPA CCKM, WPA2 AES or WPA2 CCKM for encryption and complete other entries as detailed in this section.

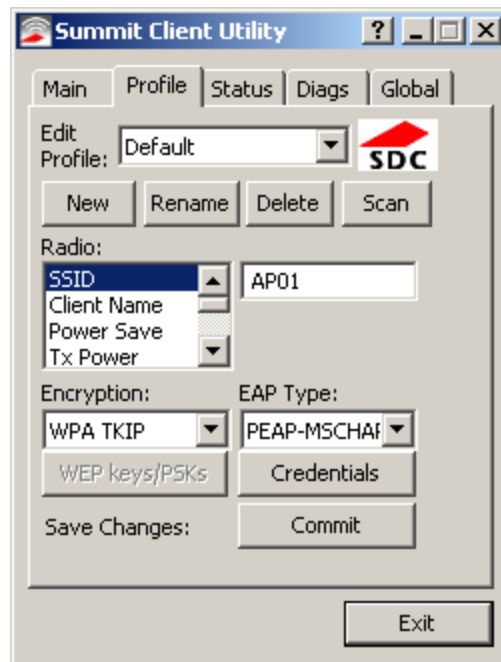

See [Sign-On vs. Stored Credentials](#) for information on entering credentials.

Click the **Credentials** button.

- No entries except the CA Certificate Filename are necessary for Sign-On Credentials as the user will be prompted for the User Name and Password when connecting to the network.
- For Stored Credentials, User, Password and the CA Certificate Filename must be entered.

Enter these items as directed below.

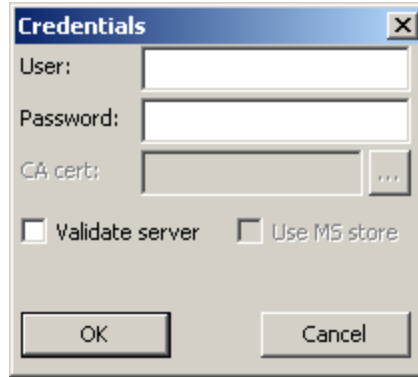

Enter the Domain\Username (if the Domain is required), otherwise enter the Username.

Enter the password.

Leave the CA Certificate File Name blank for now.

Click **OK** then click **Commit**. Ensure the correct Active profile is selected on the [Main Tab](#).

See [Windows Certificate Store vs. Certs Path](#) for more information on certificate storage.

Once successfully authenticated, import the CA certificate into the Windows certificate store. Return to the Credentials screen and check the **Validate server** checkbox.

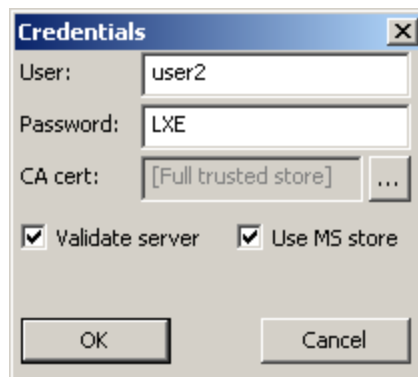

If using the Windows certificate store:

- Check the **Use MS store** checkbox. The default is to use the Full Trusted Store.
- To select an individual certificate, click on the **Browse** button.
- Uncheck the **Use full trusted store** checkbox.
- Select the desired certificate and click Select. You are returned to the Credentials screen.

If using the Certs Path option:

- Leave the **Use MS store** box unchecked.
- Enter the certificate filename in the CA Cert textbox.

Click **OK** then click **Commit**.

The device should be authenticating the server certificate and using PEAP/MSCHAP for the user authentication.

Ensure the correct Active Profile is selected on the [Main tab](#) and restart. The SCU Main tab shows the device is associated after the radio connects to the network.

Note: The date must be properly set on the device to authenticate a certificate.

PEAP/GTC

To use PEAP/GTC, make sure the following profile options are used.

- Enter the **SSID** of the Access Point assigned to this profile
- Set **EAP Type** to **PEAP-GTC**
- Set **Encryption** to **WPA TKIP**
- Set **Auth Type** to **Open**

To use another encryption type, select WPA CCKM, WPA2 AES or WPA2 CCKM for encryption and complete other entries as detailed in this section.

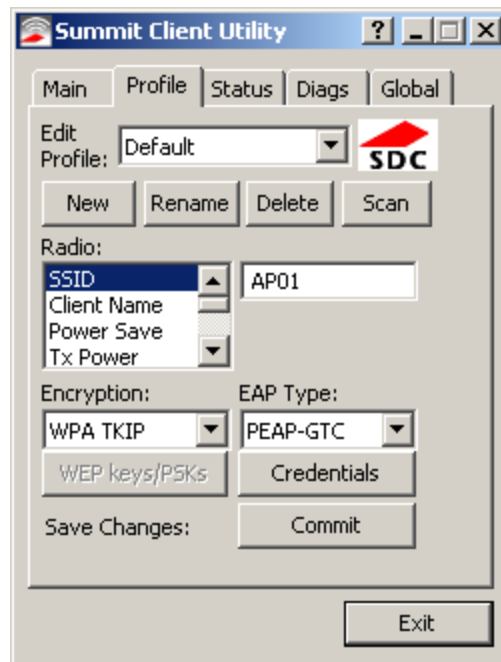

See [Sign-On vs. Stored Credentials](#) for information on entering credentials.

Click the **Credentials** button.

- No entries except the CA Certificate Filename are necessary for Sign-On Credentials as the user will be prompted for the User Name and Password when connecting to the network.

Enter these items as directed below.

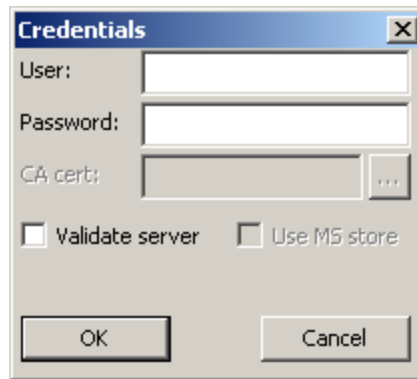

The screenshot shows a 'Credentials' dialog box with the following fields and options:

- User: [Empty text box]
- Password: [Empty text box]
- CA cert: [Empty text box] with a browse button (...)
- Validate server
- Use MS store
- OK button
- Cancel button

Enter the Domain\Username (if the Domain is required), otherwise enter the Username.

Enter the password.

Leave the CA Certificate File Name blank for now.

Click **OK** then click **Commit**. Ensure the correct Active Profile is selected on the [Main Tab](#).

See [Windows Certificate Store vs. Certs Path](#) for more information on certificate storage.

Once successfully authenticated, import the CA certificate into the Windows certificate store. Return to the Credentials screen and check the **Validate server** checkbox.

Note: Some servers may be configured to allow only a single use of the password for PEAP/GTC. In this case, wait for the token to update with a new password before attempting to validate the server. Then enter the new password, check the Validate Server checkbox and proceed with the certificate process below.

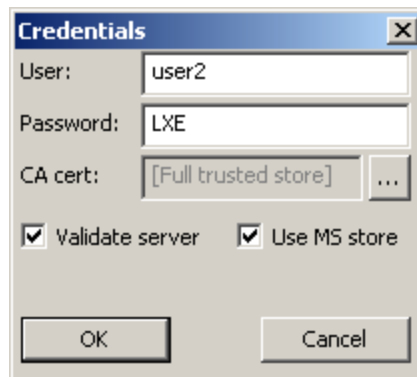

The screenshot shows the 'Credentials' dialog box with the following fields and options:

- User: user2
- Password: LXE
- CA cert: [Full trusted store] with a browse button (...)
- Validate server
- Use MS store
- OK button
- Cancel button

If using the Windows certificate store:

- Check the **Use MS store** checkbox. The default is to use the Full Trusted Store.
- To select an individual certificate, click on the **Browse** button.
- Uncheck the **Use full trusted store** checkbox.
- Select the desired certificate and click **Select**. You are returned to the Credentials screen.

If using the Certs Path option:

- Leave the **Use MS store box** unchecked.
- Enter the certificate filename in the CA Cert textbox.

Click **OK** then click **Commit**.

The device should be authenticating the server certificate and using PEAP/GTC for the user authentication.

Ensure the correct Active Profile is selected on the [Main tab](#) and restart. The SCU Main tab shows the device is associated after the radio connects to the network.

Note: The date must be properly set on the device to authenticate a certificate.

WPA/LEAP

To use WPA/LEAP, make sure the following profile options are used.

- Enter the **SSID** of the Access Point assigned to this profile
- Set **EAP Type** to **LEAP**
- Set **Encryption** to **WPA TKIP**
- Set **Auth Type** as follows:
 - If the Cisco/CCX certified AP is configured for open authentication, set the **Auth Type** radio parameter to **Open**.
 - If the AP is configured to use shared key or passphrase, set the Auth Type radio parameter to **Shared**.
 - If the AP is configured for network EAP only, set the **Auth Type** radio parameter to **LEAP**.

To use another encryption type, select WPA CCKM, WPA2 AES or WPA2 CCKM for encryption and complete other entries as detailed in this section.

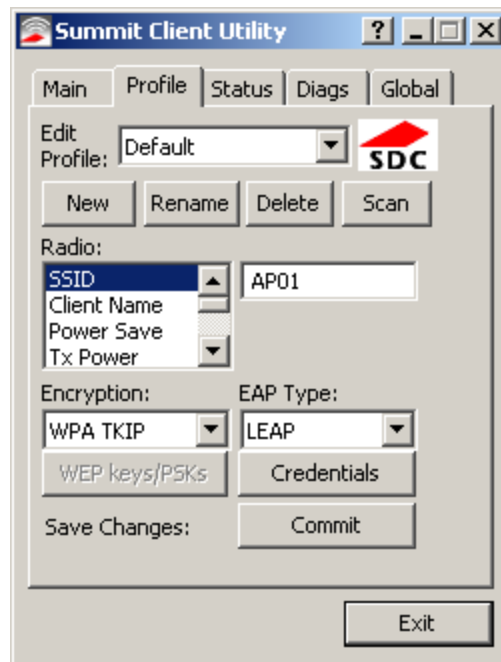

See [Sign-On vs. Stored Credentials](#) for information on entering credentials.

To use Stored Credentials, click on the **Credentials** button. No entries are necessary for Sign-On Credentials as the user will be prompted for the Username and Password when connecting to the network.

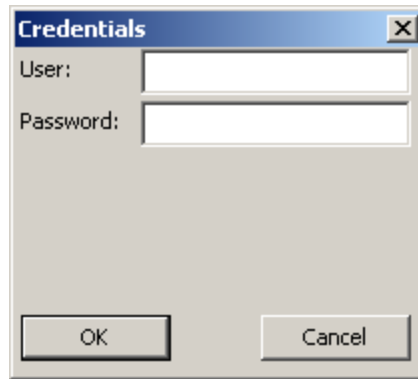

The image shows a standard Windows-style dialog box titled "Credentials". It features a blue title bar with a close button (X) in the top right corner. The main area of the dialog is light gray and contains two text input fields. The first field is labeled "User:" and the second is labeled "Password:". Below the input fields, there are two buttons: "OK" on the left and "Cancel" on the right.

Enter the Domain\Username (if the Domain is required), otherwise enter the Username.

Enter the password.

Click **OK** then click the **Commit** button.

Ensure the correct Active Profile is selected on the [Main tab](#) and restart. The SCU Main tab shows the device is associated after the radio connects to the network.

EAP-FAST

To use EAP-FAST, make sure the following profile options are used.

- Enter the **SSID** of the Access Point assigned to this profile
- Set **EAP Type** to **EAP-FAST**
- Set **Encryption** to **WPA TKIP**
- Set **Auth Type** to **Open**

To use another encryption type, select WPA CCKM, WPA2 AES or WPA2 CCKM for encryption and complete other entries as detailed in this section.

The SCU supports EAP-FAST with automatic or manual PAC provisioning. With automatic PAC provisioning, the user credentials, whether entered on the saved credentials screen or the sign on screen, are sent to the RADIUS server. The RADIUS server must have auto provisioning enabled to send the PAC provisioning credentials to the Thor VX8.

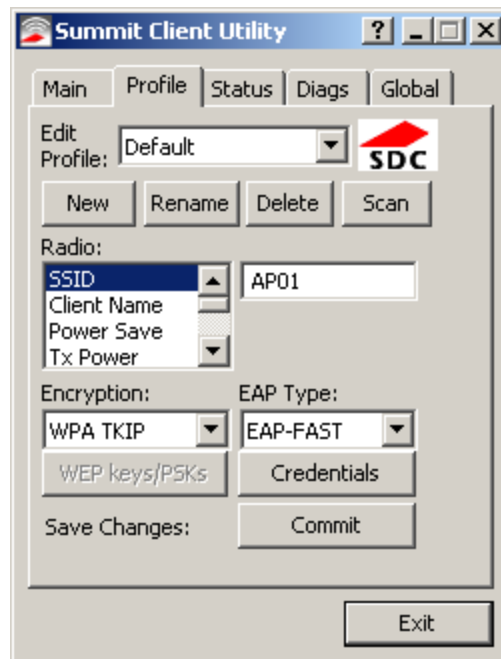

For automatic PAC provisioning, once a username/password is authenticated, the PAC information is stored on the Thor VX8. The same username/password must be used to authenticate each time. See the note below for more details.

For manual PAC provisioning, the PAC filename and Password must be entered.

See [Sign-On vs. Stored Credentials](#) for information on entering credentials.

The entries on the Credentials screen are determined by the type of credentials (stored or sign on) and the type of PAC provisioning (automatic or manual).

Click on the **Credentials** button.

To use Stored Credentials, click on the **Credentials** button. No entries are necessary for Sign-On Credentials with automatic PAC provisioning as the user will be prompted for the Username and Password when connecting to the network.

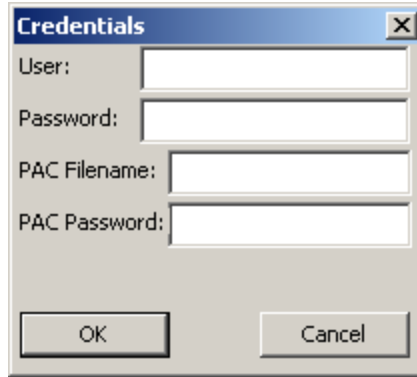

To use Sign-On credentials:

- Do not enter a User and Password as the user will be prompted for the Username and Password when connecting to the network.

To use Stored Credentials:

- Enter the Domain\Username (if the Domain is required), otherwise enter the Username.
- Enter the password.

To use Automatic PAC Provisioning:

- No additional entries are required.

To use manual PAC Provisioning:

- Enter the PAC Filename and PAC Password.
- The PAC file must be copied to the directory specified in the Certs Path global variable. The PAC file must not be read only.

Tap **OK** then click the **Commit** button.

Ensure the correct Active Profile is selected on the [Main tab](#) and restart. The SCU Main tab shows the device is associated after the radio connects to the network.

Note: When using Automatic PAC Provisioning, once authenticated, there is a file stored in the \Program Files\Summit\cert folder with the PAC credentials. If the username is changed, that file must be deleted. The filename is autoP.00.pac.

EAP-TLS

To use EAP-TLS, make sure the following profile options are used.

- Enter the **SSID** of the Access Point assigned to this profile
- Set **EAP Type** to **EAP-TLS**
- Set **Encryption** to **WPA TKIP**
- Set **Auth Type** to **Open**

To use another encryption type, select WPA CCKM, WPA2 AES or WPA2 CCKM for encryption and complete other entries as detailed in this section.

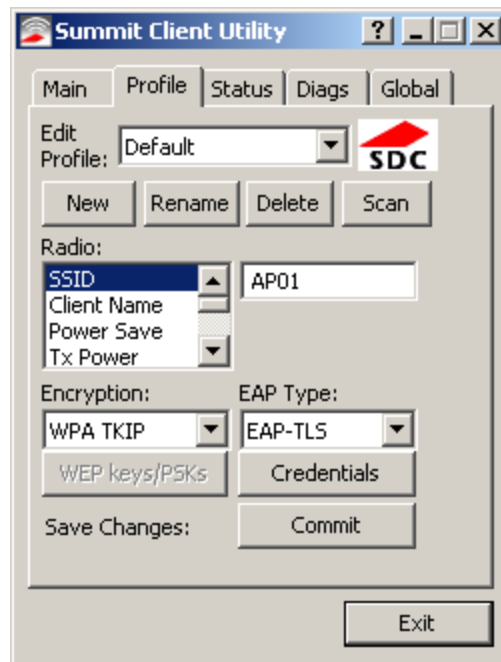

See [Sign-On vs. Stored Credentials](#) for information on entering credentials.

Click the **Credentials** button.

- No entries except the User Certificate Filename and the CA Certificate Filename are necessary for Sign-On Credentials as the user will be prompted for the User Name when connecting to the network.
- For Stored Credentials, User Certificate Filename and the CA Certificate Filename must be entered.

Enter these items as directed below.

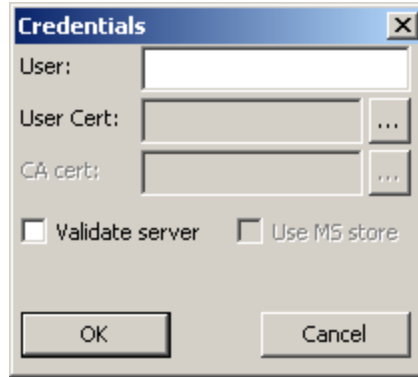

Enter the Domain\Username (if the Domain is required), otherwise enter the Username.

Select a user certificate from the Windows certificate store. Use the **Browse** button to locate the User Cert from the certificate store. Highlight the desired certificate and press the **Select** button. The name of the certificate is displayed in the User Cert box.

Some versions of the SCU require a User Cert password. If this entry field is present, enter the password for the user certificate in the User Cert pwd box.

If there are no user certificates in the Windows certificate store, follow these instructions to [generate](#) and [install](#) the user certificate.

See [Windows Certificate Store vs. Certs Path](#) for more information on CA certificate storage.

Check the **Validate server** checkbox.

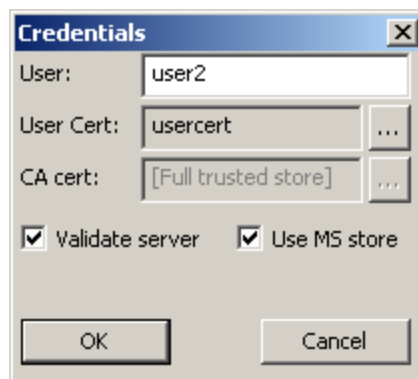

If using the Windows certificate store:

- Check the **Use MS store** checkbox. The default is to use the Full Trusted Store.
- To select an individual certificate, click on the **Browse** button.
- Uncheck the **Use full trusted store** checkbox.
- Select the desired certificate and click **Select**. You are returned to the Credentials screen.

If using the Certs Path option:

- Leave the Use MS store box unchecked.
- Enter the certificate filename in the CA Cert textbox.

Click **OK** then click **Commit**.

The Thor VX8 should be authenticating the server certificate and using EAP-TLS for the user authentication.

Ensure the correct Active Profile is selected on the [Main tab](#) and restart. The SCU Main tab shows the device is associated after the radio connects to the network.

See [Certificates](#) for information on generating a Root CA certificate or a User certificate.

Note: The date must be properly set on the device to authenticate a certificate.

WPA PSK

To connect using WPA/PSK, make sure the following profile options are used:

- Enter the **SSID** of the Access Point assigned to this profile
- Set **EAP Type** to **None**
- Set **Encryption** to **WPA PSK** or **WPA2 PSK**
- Set **Auth Type** to **Open**

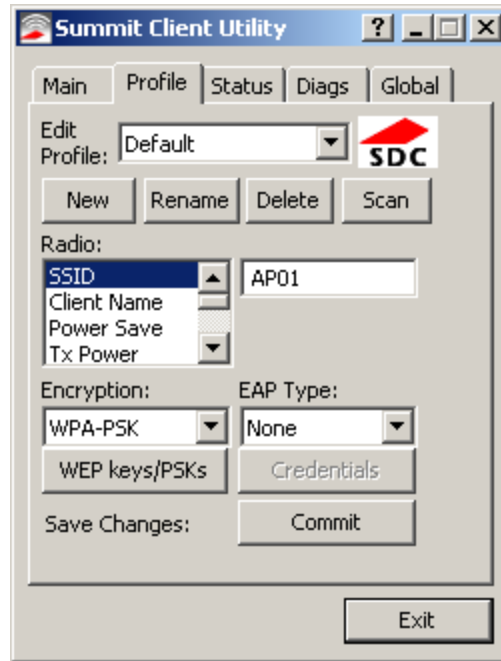

Click the **WEP keys/PSKs** button.

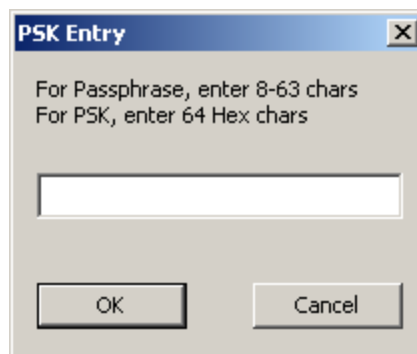

This value can be 64 hex characters or an 8 to 63 byte ASCII value. Enter the key and click **OK**.

Once configured, click the **Commit** button.

Ensure the correct Active Profile is selected on the [Main tab](#) and restart. The SCU Main tab shows the device is associated after the radio connects to the network.

Certificates

Note: Please refer to the Security Primer to prepare the Authentication Server and Access Point for communication.

Note: It is important that all dates are correct on the Thor VX8 and host computers when using any type of certificate. Certificates are date sensitive and if the date is not correct authentication will fail.



If using the Windows Certificate Store, the Windows Account must have a password. The password cannot be left blank. The Summit Client Utility uses the Windows user account credentials to access the Certificate Store. The Windows user account credentials need not be the same as the [wireless credentials](#) entered in the Summit Client Utility.

Root Certificates are necessary for EAP-TLS, PEAP/GTC and PEAP/MSCHAP.

1. [Generate a Root CA Certificate](#) either from the Thor VX8 or using a PC.
2. If a PC was used to request the certificate, copy the certificate to the Thor VX8.
3. [Install the Root CA Certificate](#).

User Certificates are necessary for EAP-TLS

1. [Generate a User Certificate](#) either from the Thor VX8 or using a PC.
2. If a PC was used to request the certificate, copy the certificate to the Thor VX8.
3. [Install the User Certificate](#).
4. [Verify installation](#).

Generating a Root CA Certificate

Note: It is important that all dates are correct on the Thor VX8 and host computers when using any type of certificate. Certificates are date sensitive and if the date is not correct authentication will fail.

The easiest way to get the root CA certificate is to use a browser on a PC to navigate to the Certificate Authority. To request the root CA certificate, open a browser to

<http://<CA IP address>/certsrv>.

It may be necessary to use a PC to request the certificate for these devices.

Sign into the CA with any valid username and password.

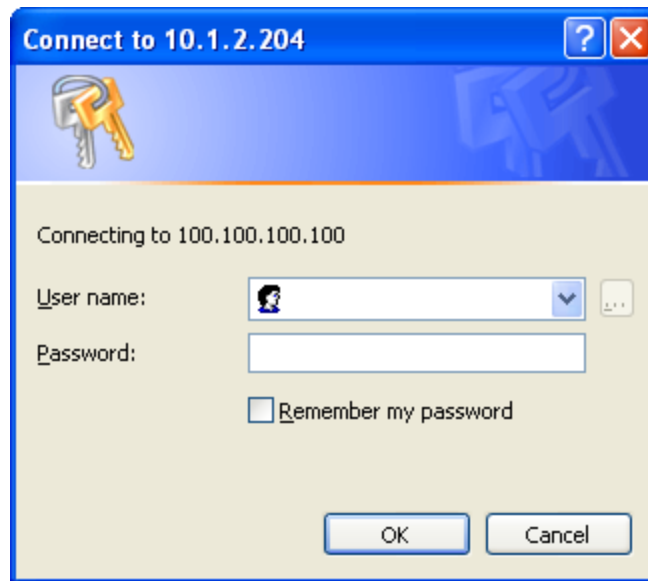

Welcome

Use this Web site to request a certificate for your Web browser, e-mail client, or other program. By using a certificate, you can verify your identity to people you communicate with over the Web, sign and encrypt messages, and, depending upon the type of certificate you request, perform other security tasks.

You can also use this Web site to download a certificate authority (CA) certificate, certificate chain, or certificate revocation list (CRL), or to view the status of a pending request.

For more information about Certificate Services, see [Certificate Services Documentation](#).

Select a task:

[Request a certificate](#)

[View the status of a pending certificate request](#)

[Download a CA certificate, certificate chain, or CRL](#)

Click the **Download a CA certificate, certificate chain or CRL** link.

Make sure the correct root CA certificate is selected in the list box.

Download a CA Certificate, Certificate Chain, or CRL

To trust certificates issued from this certification authority, [install this CA certificate chain](#).

To download a CA certificate, certificate chain, or CRL, select the certificate and encoding method.

CA certificate:

Current

Encoding method:

- DER
 Base 64

[Download CA certificate](#)

[Download CA certificate chain](#)

[Download latest base CRL](#)

[Download latest delta CRL](#)

Click the **DER** button.

To download the CA certificate, click on the **Download CA certificate** link.

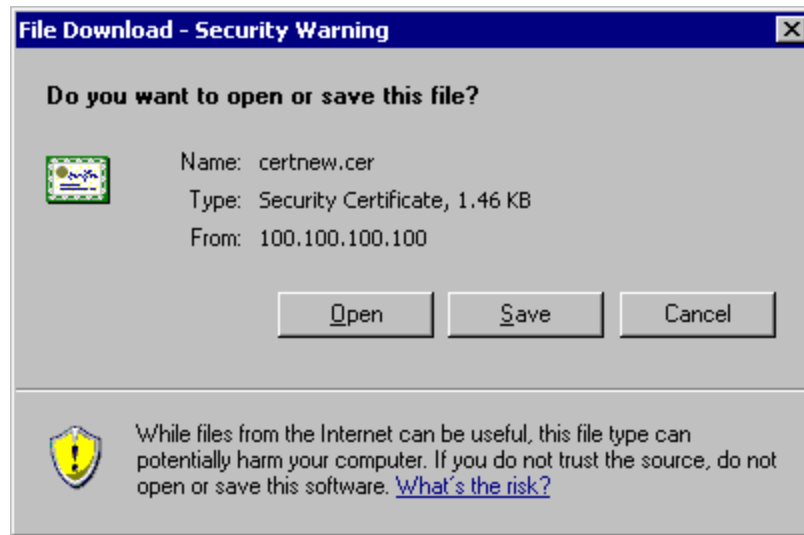

Click the **Save** button and save the certificate. Make sure to keep track of the name and location of the certificate. [Install](#) the certificate on the Thor VX8.

Installing a Root CA Certificate

Note: This section is only if the Windows certificate store is used. If the certificate store is not used, copy the certificate to the C:\Program Files\Summit\certs folder or other path specified in the Summit Certs global parameter.

Copy the certificate file to the Thor VX8. The certificate file has a .CER extension. Locate the file and double-click on it.

If presented with a security warning, confirm that you want to open the file.

Troubleshooting: If the Certificate Wizard does not start automatically when you double-tap the certificate .CER file:

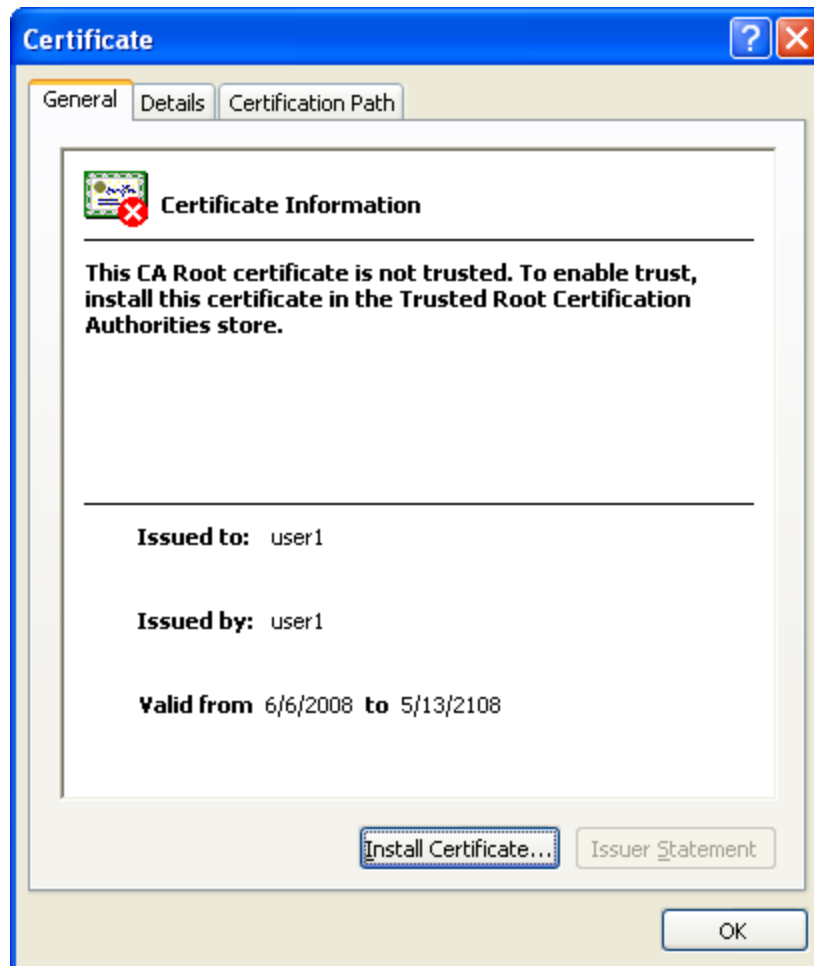

1. Select **Start > Run** and type **certmgr.msc** in the text box and tap **OK**.
2. Select **Start > Run** and type **certmgr.msc** in the text box and tap **OK**.
3. Select **Start** and type **certmgr.msc** in the search box and press **Enter**.
4. In the left pane, right-click **Trusted Root Certificate Authorities** and select **All Tasks > Import**.
5. The Certificate Import Wizard starts.
6. Tap **Next** and use the **Browse...** button to locate the Root certificate copied to the Thor VX8 then tap **Open**.
7. The certificate filename and path are displayed. Tap **Next**.
8. Follow the instructions from this [point](#).



Click the **Install Certificate** button.

The certificate import wizard starts. Tap **Next**.

Complete the Root CA Certificate Installation

	<ul style="list-style-type: none">• Select Place all certificates in the following store.• Tap Browse and select Trusted Root Certification Authorities.• Tap OK, then tap Next and Finish.• If presented with a security warning, confirm that you want to install this certificate.• An import successful message is displayed.
	<ul style="list-style-type: none">• Allow Windows to automatically select the certificate store.• Tap Next and Finish.• An import successful message is displayed.

Generating a User Certificate

The easiest way to get the user certificate is to use the browser on the Thor VX8 or a PC to navigate to the Certificate Authority. To request the user certificate, open a browser to

<http://<CA IP address>/certsrv>.

It may be necessary to use a PC to request the certificate for these devices.

Sign into the CA with the username and password of the person who will be logging into the mobile device.

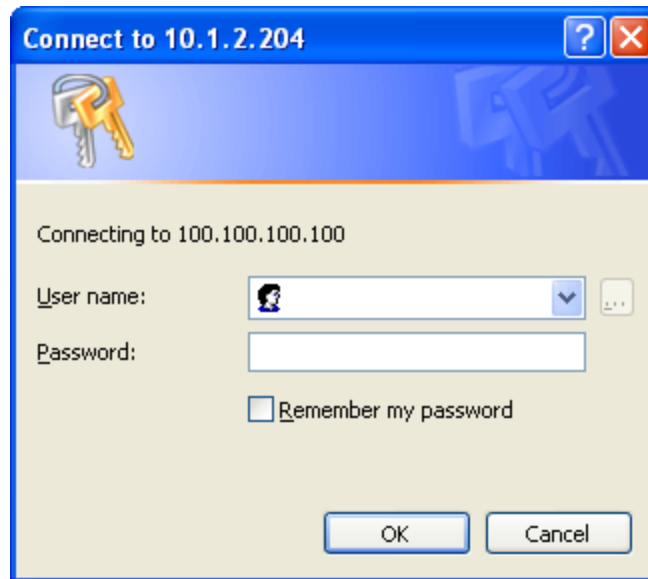

This process saves a user certificate file. There is no separate private key file as used on Windows CE devices.

Welcome

Use this Web site to request a certificate for your Web browser, e-mail client, or other program. By using a certificate, you can verify your identity to people you communicate with over the Web, sign and encrypt messages, and, depending upon the type of certificate you request, perform other security tasks.

You can also use this Web site to download a certificate authority (CA) certificate, certificate chain, or certificate revocation list (CRL), or to view the status of a pending request.

For more information about Certificate Services, see [Certificate Services Documentation](#).

Select a task:

[Request a certificate](#)

[View the status of a pending certificate request](#)

[Download a CA certificate, certificate chain, or CRL](#)

Click the **Request a certificate** link.

Request a Certificate

Select the certificate type:

[User Certificate](#)

Or, submit an [advanced certificate request](#).

Click on the **User Certificate** link.

User Certificate - Identifying Information

No further identifying information is required. To complete your certificate, press submit:

[More Options >>](#)

Click on the **Submit** button. if there is a message box asking if you want to confirm the request, click **Yes**.
The User Certificate is issued.

Certificate Issued

The certificate you requested was issued to you.



[Install this certificate](#)

Install the user certificate on the requesting computer by clicking the **Install this certificate** link.
If the requesting computer is the Thor VX8, then the process is finished. otherwise, export the certificate as described below.

Exporting a User Certificate

Select **Tools > Internet Options > Content** and click the **Certificates** button.

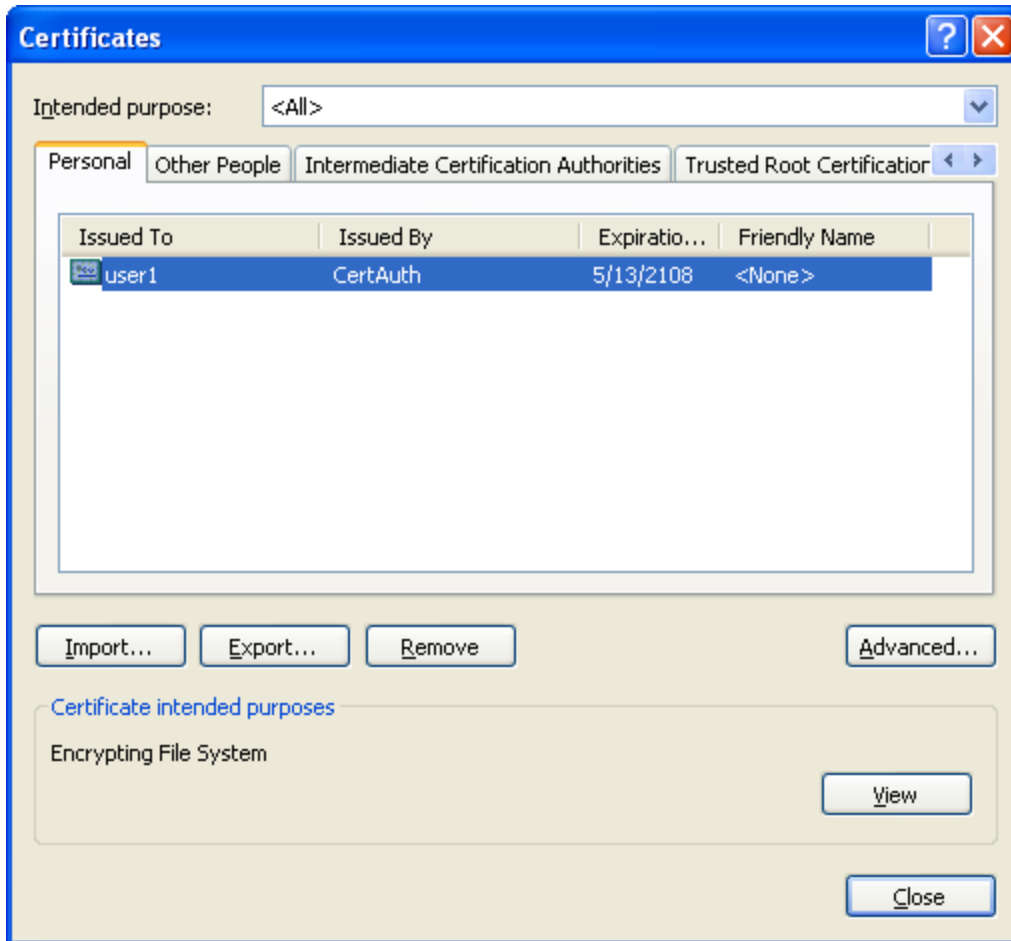

Make sure the **Personal** tab is selected. Highlight the certificate and click the **Export** button.

The Certificate Export Wizard is started

Select **Yes, export the private key** and click Next.

Do you want to export the private key with the certificate?

- Yes, export the private key
- No, do not export the private key

Uncheck **Enable strong protection** and check **Next**.
The certificate type must be PKCS #12 (.PFX).

- Personal Information Exchange - PKCS #12 (.PFX)
 - Include all certificates in the certification path if possible
 - Enable strong protection (requires IE 5.0, NT 4.0 SP4 or above)
 - Delete the private key if the export is successful

When the private key is exported, you must enter the password, confirm the password and click **Next**. Be sure to remember the password as it is needed when installing the certificate.

Type and confirm a password.

Password:

Confirm password:

Supply the file name for the certificate. Use the **Browse** button to select the folder where you wish to store the certificate. The certificate is saved with a .PFX extension.

File name:

Click Finish and OK to close the Successful Export message.



Locate the User Certificate in the specified location. Copy to the Thor VX8. [Install](#) the User certificate.

Installing a User Certificate

After [generating](#) and [exporting](#) the user certificate, copy it from the PC to the Thor VX8. Copy the certificate to a location on the Thor VX8.

Locate the certificate file (it has a .PFX extension) and double-click on it.

Troubleshooting: If the Certificate Wizard does not start automatically when you double-tap the certificate .PFX file:

1.  Select **Start > Run** and type **certmgr.msc** in the text box and tap **OK**.
2.  Select **Start** and type **certmgr.msc** in the search box and press **Enter**.
3. In the left pane, right-click **Personal** and select **All Tasks > Import**.
4. The Certificate Import Wizard starts.
5. Tap **Next** and use the **Browse...** button to locate the User certificate copied to the Thor VX8. If necessary, change the file type drop down list at the bottom of the explorer window from *.cer to *.pfx. After selecting the .PFX file, tap **Open**.
6. The certificate filename and path are displayed. Tap **Next**.
7. Follow the instructions that follow starting with the [prompt for password](#).

The certificate import wizard starts. Tap **Next**.

Confirm the certificate file name and location. Tap **Next**.

You are prompted for the password that was assigned when the certificate was exported.

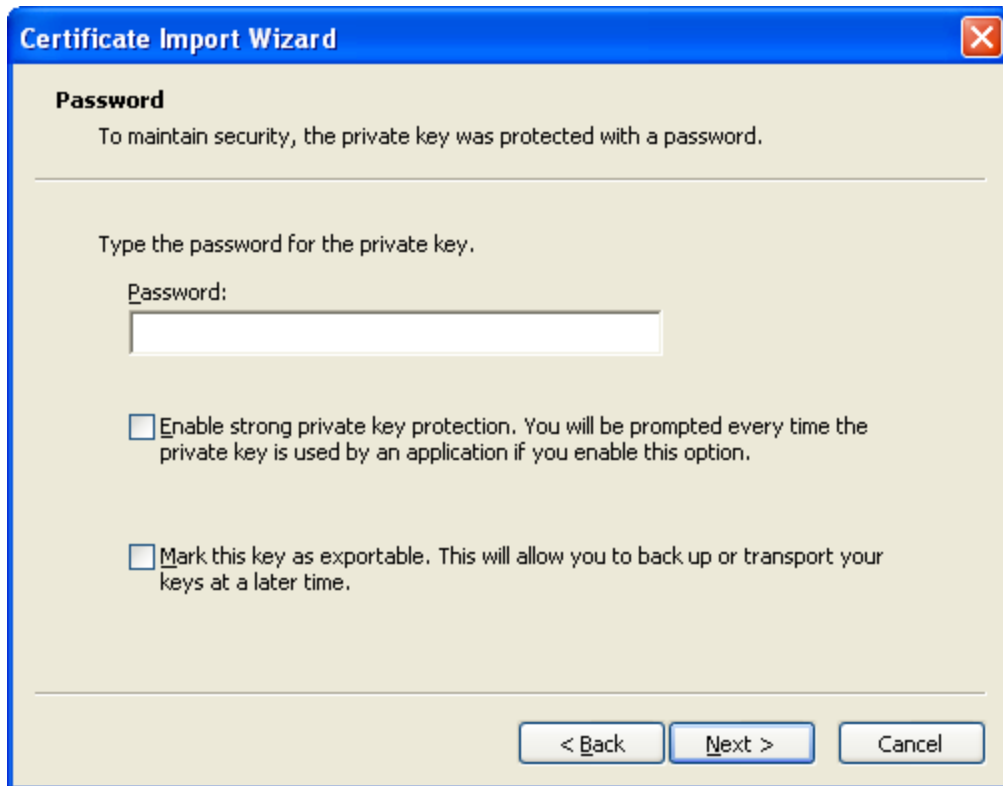

It is not necessary to select either of the checkboxes displayed above.

	For these devices, there is a third checkbox: Include all extended properties . This checkbox should remain checked.
--	---

Enter the password and tap **Next**.

On the next screen, allow Windows to automatically select the certificate store, then click **Next** and **Finish**. An import successful message is displayed.

Atheros Client Utility - 802.11a/b/g Radio

- ⦿ Windows® Embedded Standard
- ◊ Windows® XP Embedded / Professional

The 802.11b/g radio is configured with the Atheros® Client Utility (ACU). The ACU can be accessed by:

- Selecting **Start > All Programs > Atheros > Atheros Client Utility**
- Clicking on the **Atheros Client Utility** on the desktop
- Clicking on the **ACU** icon in the system tray.



The appearance of the ACU icon in the system tray varies depending on the strength or lack of an available wireless connection.

Wireless Zero Config

This section assumes the ACU is used to configure the radio. However, it is possible to use the Windows Wireless Zero Config (WZC) utility to configure the radio.

To use WZC to configure the radio:

- Double-click on the **network** icon in the taskbar.
- Double-click on the **wireless connection**.
- Click on **View Wireless Networks**.
- Click on **Change Advanced Settings**.
- Select the **Wireless Networks** tab.
- Check **Let this tool manage your wireless networks**.
- Click **OK**.

The Windows WZC utility can now be used to configure the radio. Please refer to the Help function in Microsoft Windows for more information on using Windows to configure the wireless network connection.

To return radio control to the ACU, uncheck the checkbox.

Using the ACU

There are many features contained in the ACU that are not covered in this document. For more information, click the ? button then click on the desired section of the ACU screen.

The **Profile Management** tab displays any currently configured connection profiles.

To create a network profile, follow these steps:

1. Click **New**.

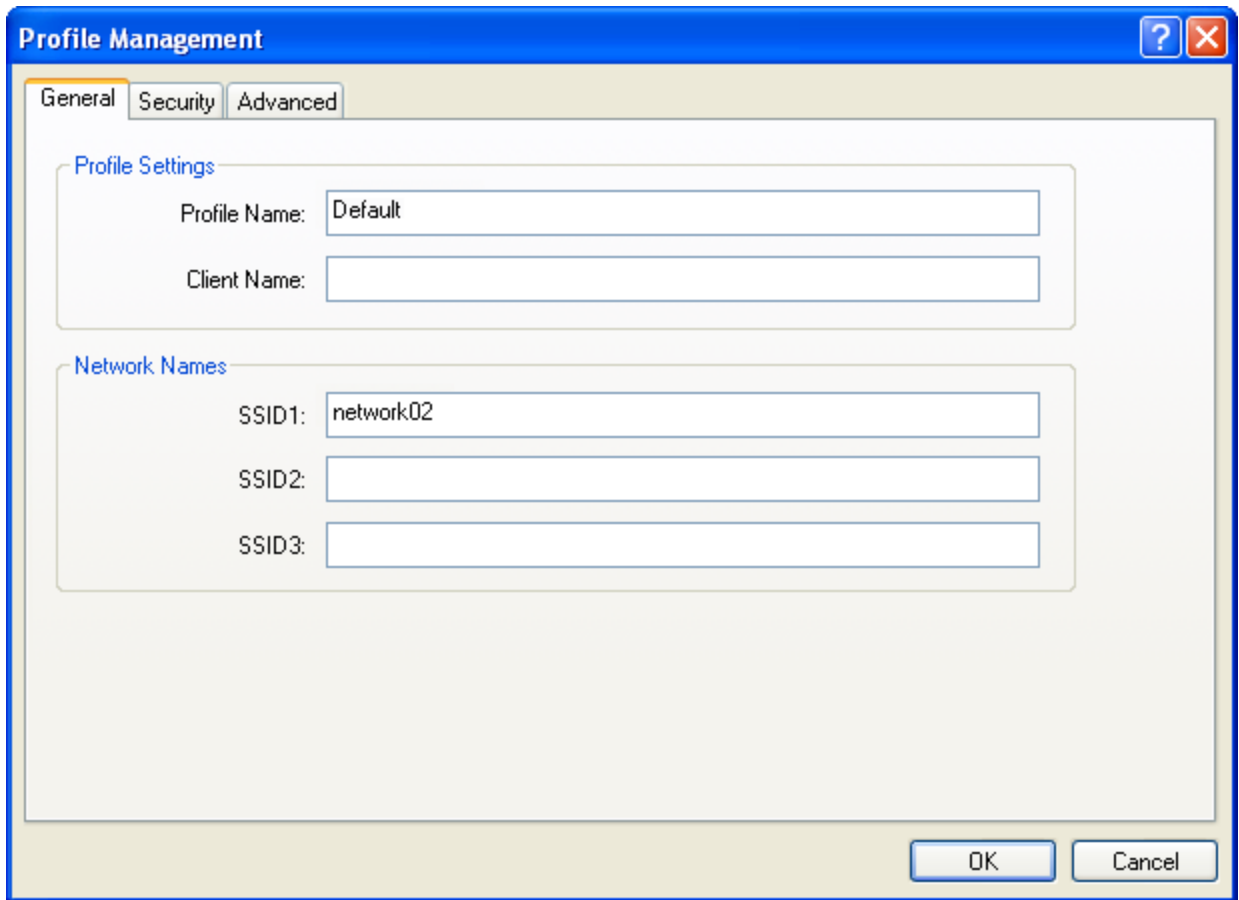

The screenshot shows a dialog box titled "Profile Management" with a blue header bar containing a help icon (?) and a close icon (X). Below the header are three tabs: "General" (selected), "Security", and "Advanced". The "General" tab contains two sections: "Profile Settings" and "Network Names".

Profile Settings:

- Profile Name: Default
- Client Name: (empty text box)

Network Names:

- SSID1: network02
- SSID2: (empty text box)
- SSID3: (empty text box)

At the bottom right of the dialog are "OK" and "Cancel" buttons.

2. Enter a **Profile Name** and an **SSID** on the General tab.
3. Click on the **Security** tab and see the following sections for the desired network security option.

No Security

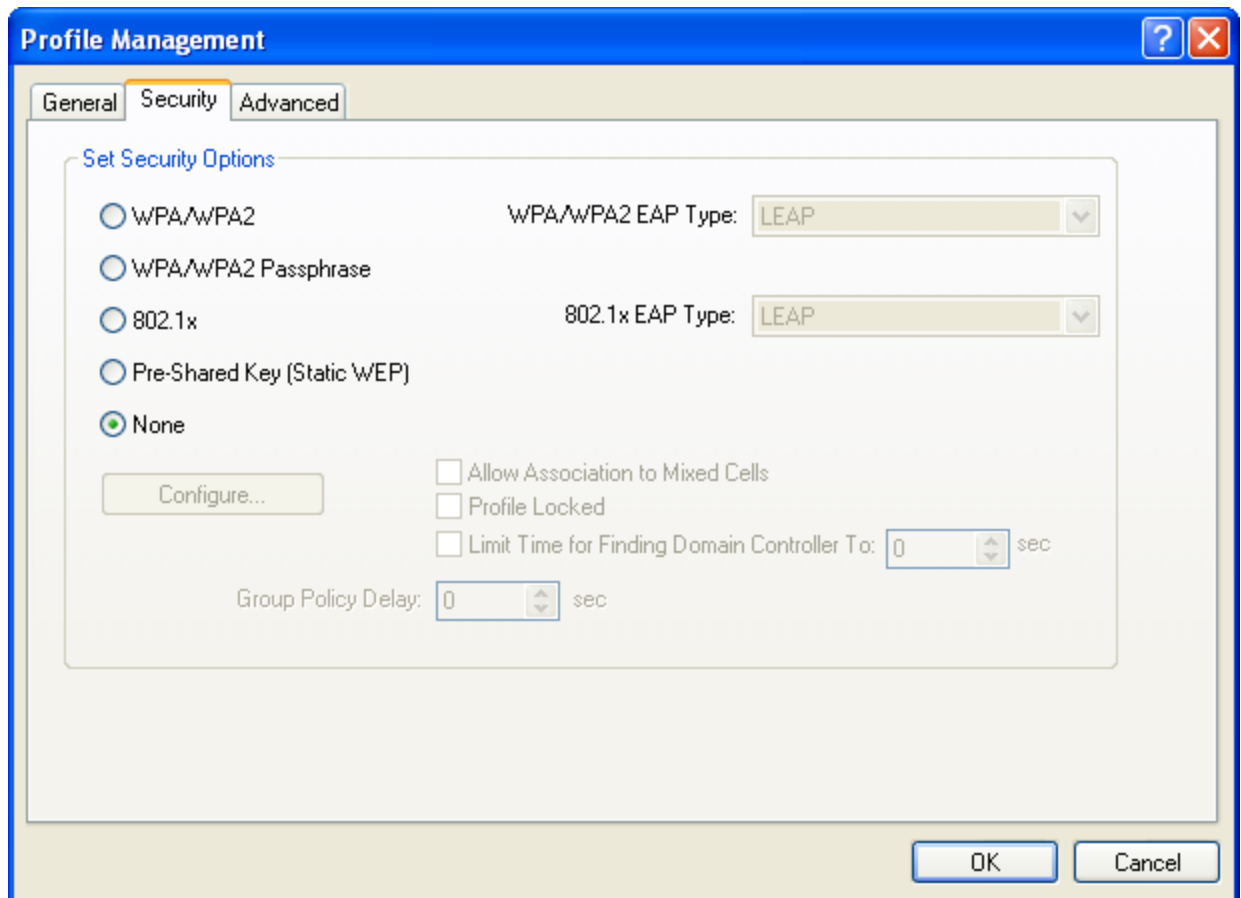

1. Select **None** from **Set Security Options**.
2. Click **OK** to save the profile.
3. Make sure the desired profile is selected on the **Profile Management** screen. Double-clicking on any profile makes that profile active.

WEP

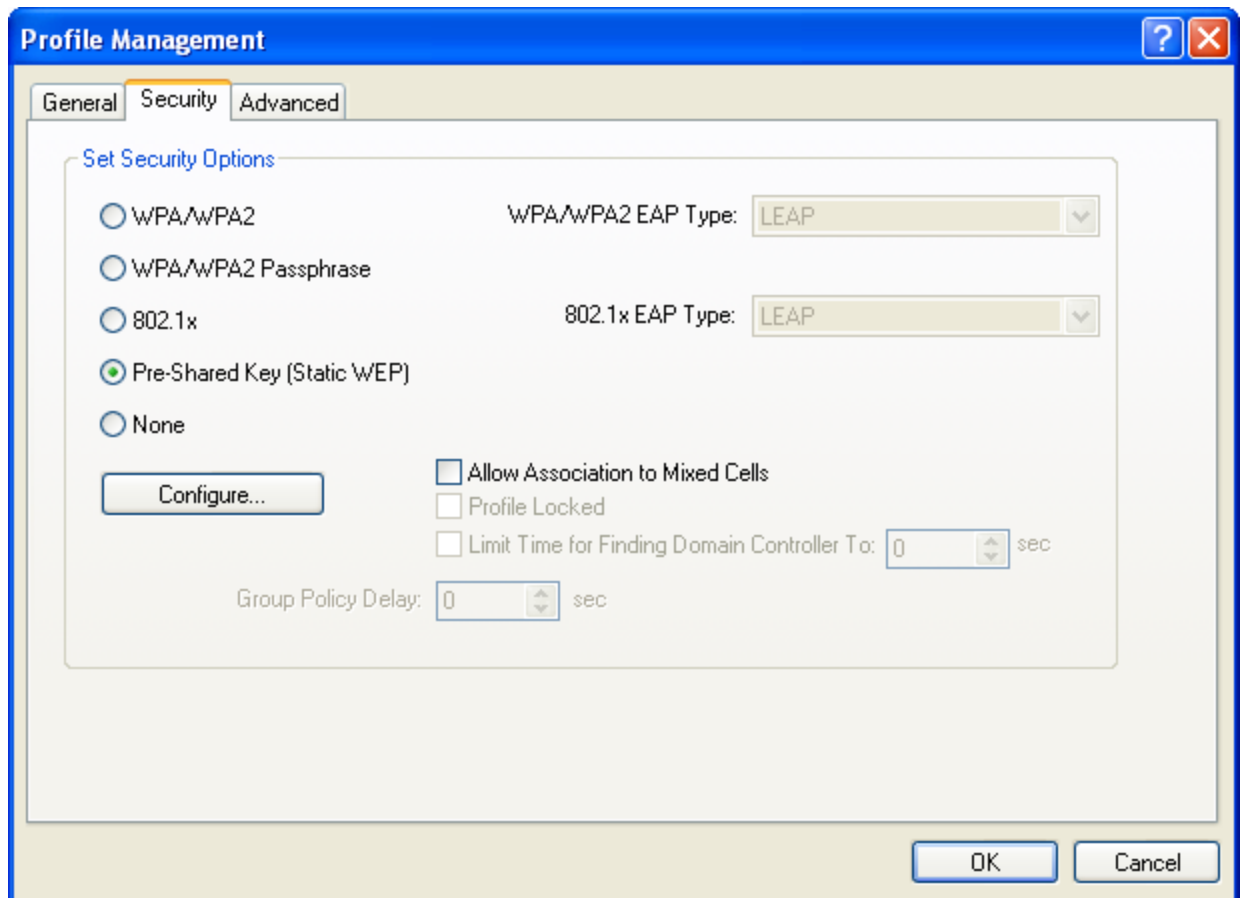

1. Select **Pre-Shared Key (Static WEP)** from **Set Security Options**.
2. Click the **Configure** button.

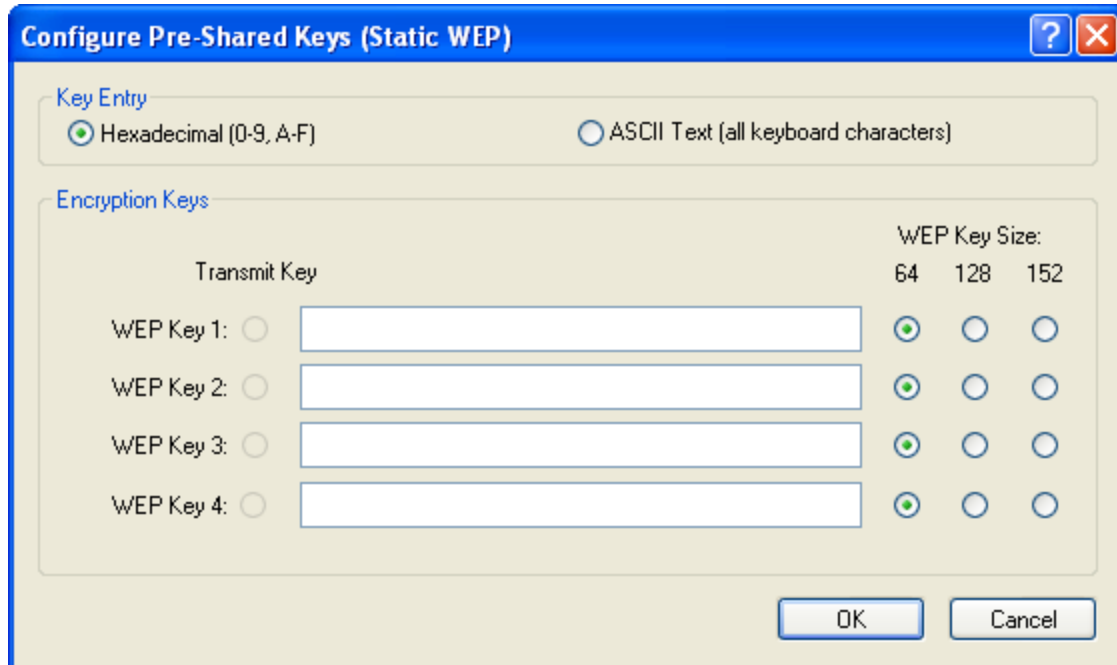

3. Enter the **WEP key**. The key can be in Hexadecimal or ASCII format.
4. Click **OK** to save the WEP key(s) then click **OK** again to save the profile.
5. Make sure the desired profile is selected on the **Profile Management** screen. Double-clicking on any profile makes that profile active.

LEAP

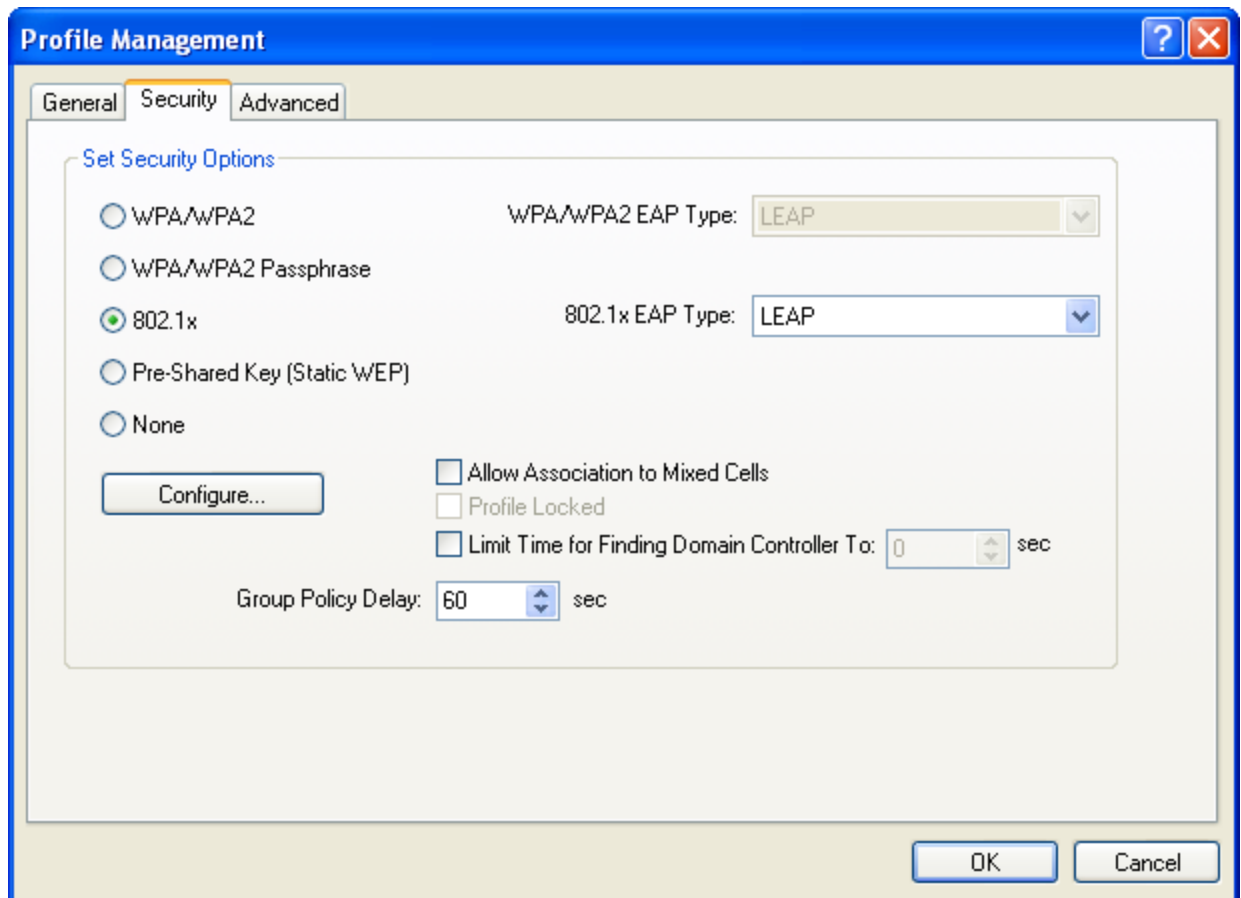

1. Select **802.1x** from **Set Security Options**.
2. Choose **LEAP** from the **802.1x EAP Type** pulldown.
3. Click the **Configure** button.

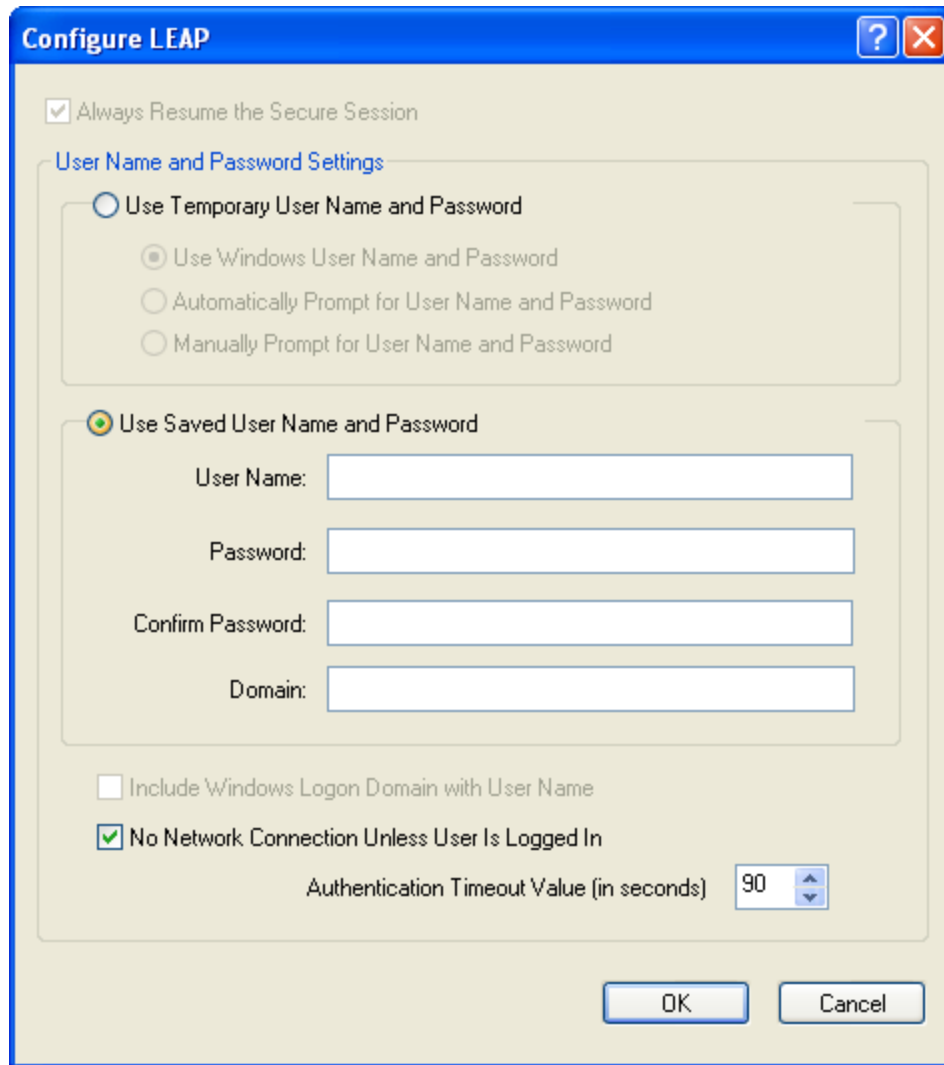

4. Make sure **Use Saved User Name and Password** is selected.
5. Enter the user credentials.
6. Click **OK** to save the credential information and then click **OK** again to save the profile.
7. Make sure the desired profile is selected on the **Profile Management** screen. Double-clicking on any profile makes that profile active.

WPA-PSK

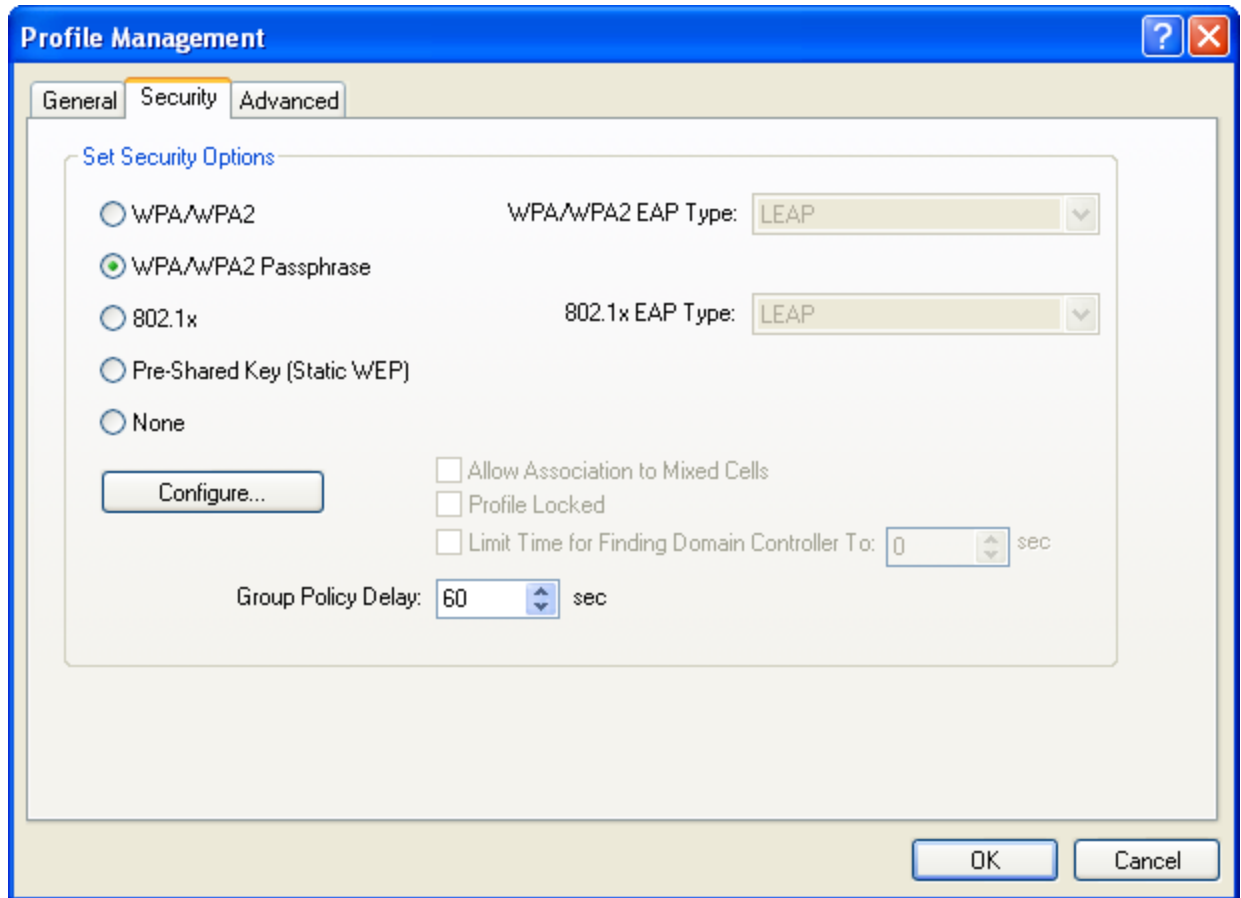

1. Select **WPA/WPA2 Passphrase** from **Set Security Options**.
2. Click the **Configure** button.

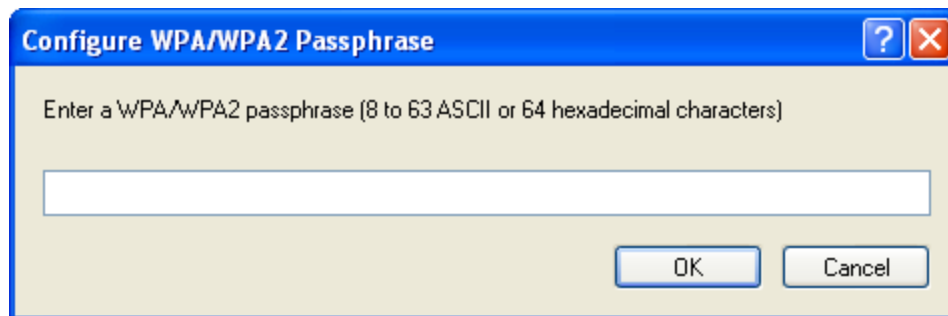

3. Enter the passphrase.
4. Click **OK** to save the passphrase and then click **OK** again to save the profile.
5. Make sure the desired profile is selected on the **Profile Management** screen. Double-clicking on any profile makes that profile active.

PEAP/MS-CHAP

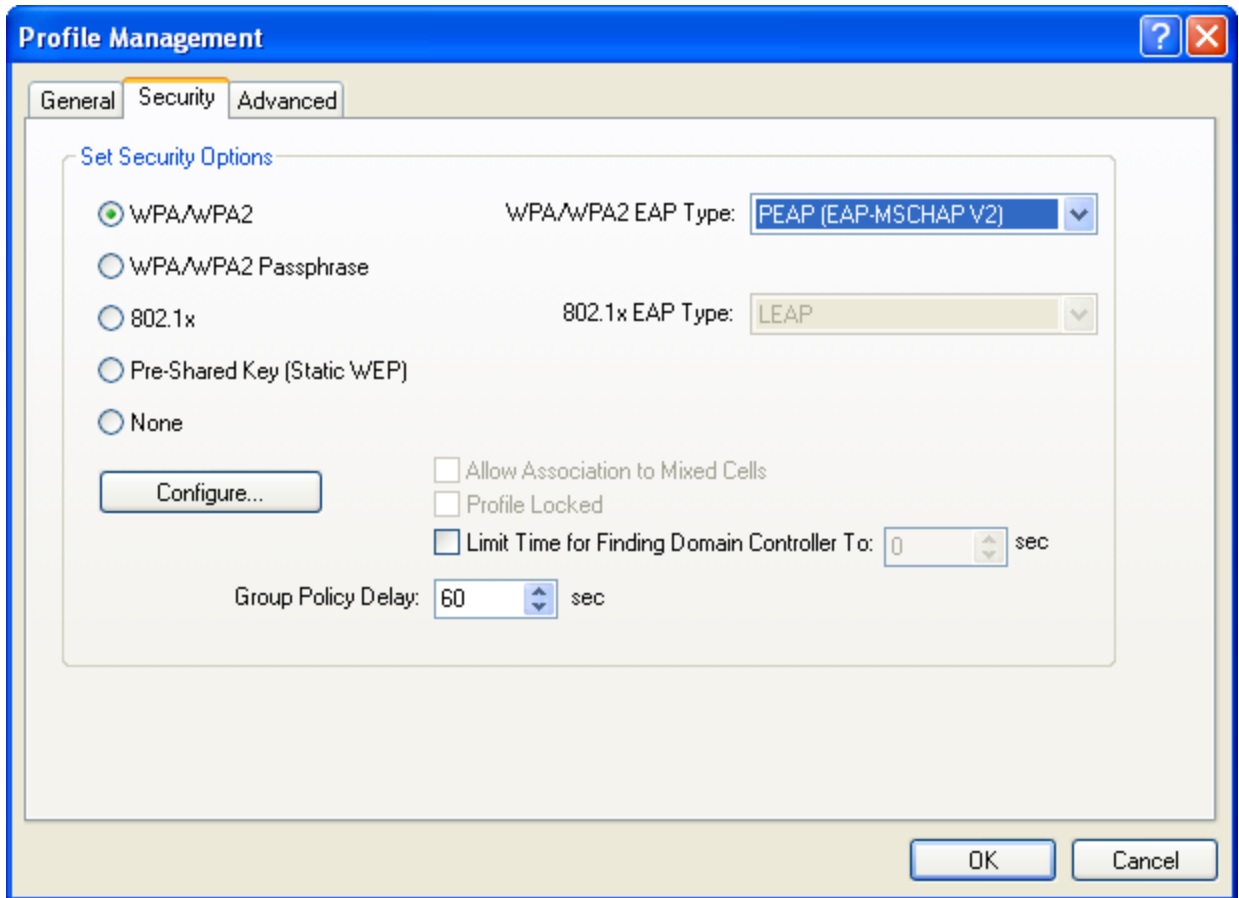

1. Select **WPA/WPA2** from **Set Security Options**.
2. Choose **PEAP (EAP-MSCHAP V2)** from the **WPA/WPA2 EAP Type** pulldown.
3. Click the **Configure** button.

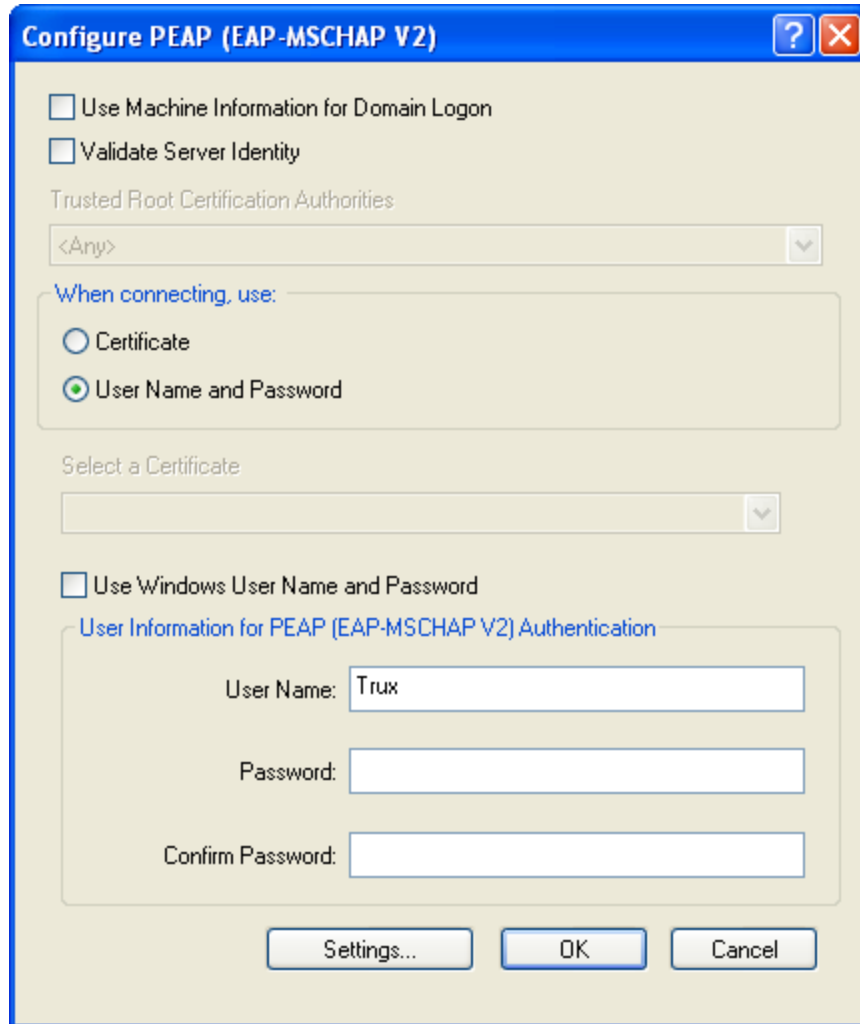

4. Make sure **User Name and Password** is selected.
5. Enter the user credentials.
6. Click **OK** to save the credential information and then click **OK** again to save the profile.
7. Make sure the desired profile is selected on the **Profile Management** screen. Double-clicking on any profile makes that profile active.

PEAP-GTC

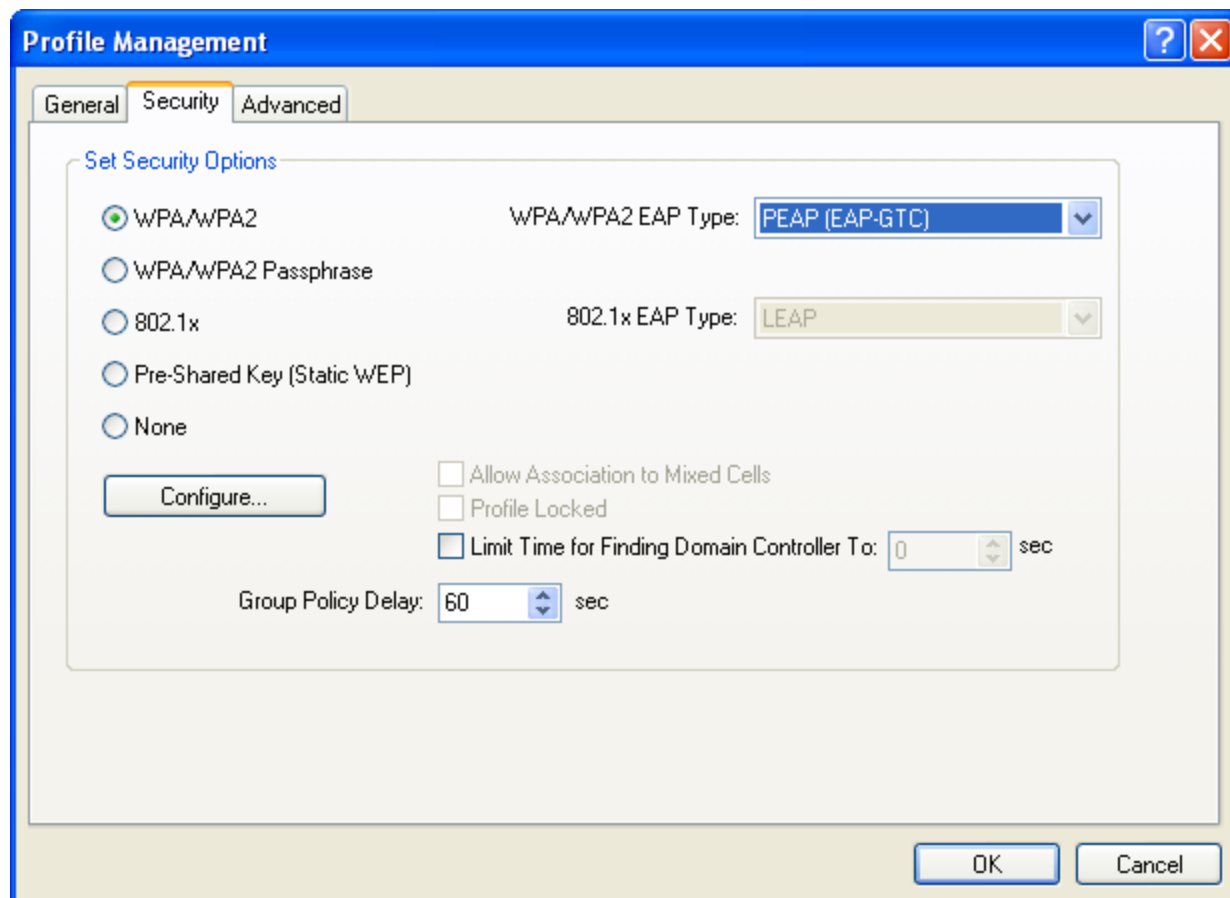

1. Select **802.1x** from **Set Security Options**.
2. Choose **PEAP (EAP-GTC)** from the **WPA/WPA2 EAP Type** pulldown.
3. Click the **Configure** button.

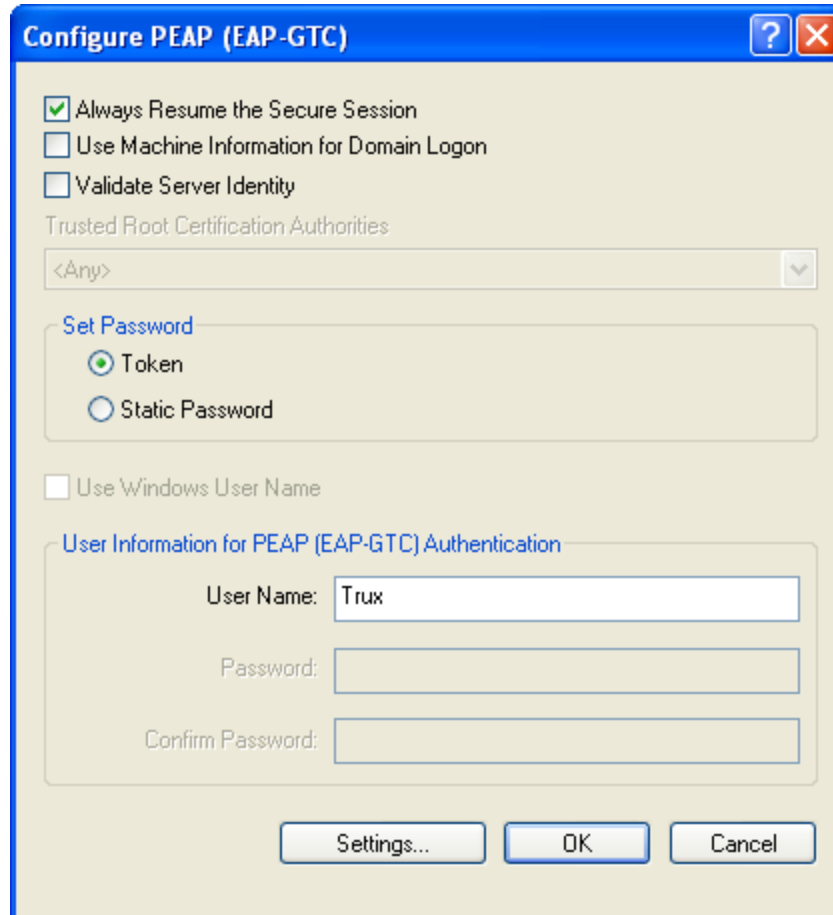

4. Enter the token **User Name**.
5. Click **OK** to save the credential information and then click **OK** again to save the profile.
6. Make sure the desired profile is selected on the **Profile Management** screen. Double-clicking on any profile makes that profile active.

EAP-TLS

EAP-TLS requires that appropriate server and user certificates are installed on the Thor VX8 computer. Please refer to [Certificates](#) for details.

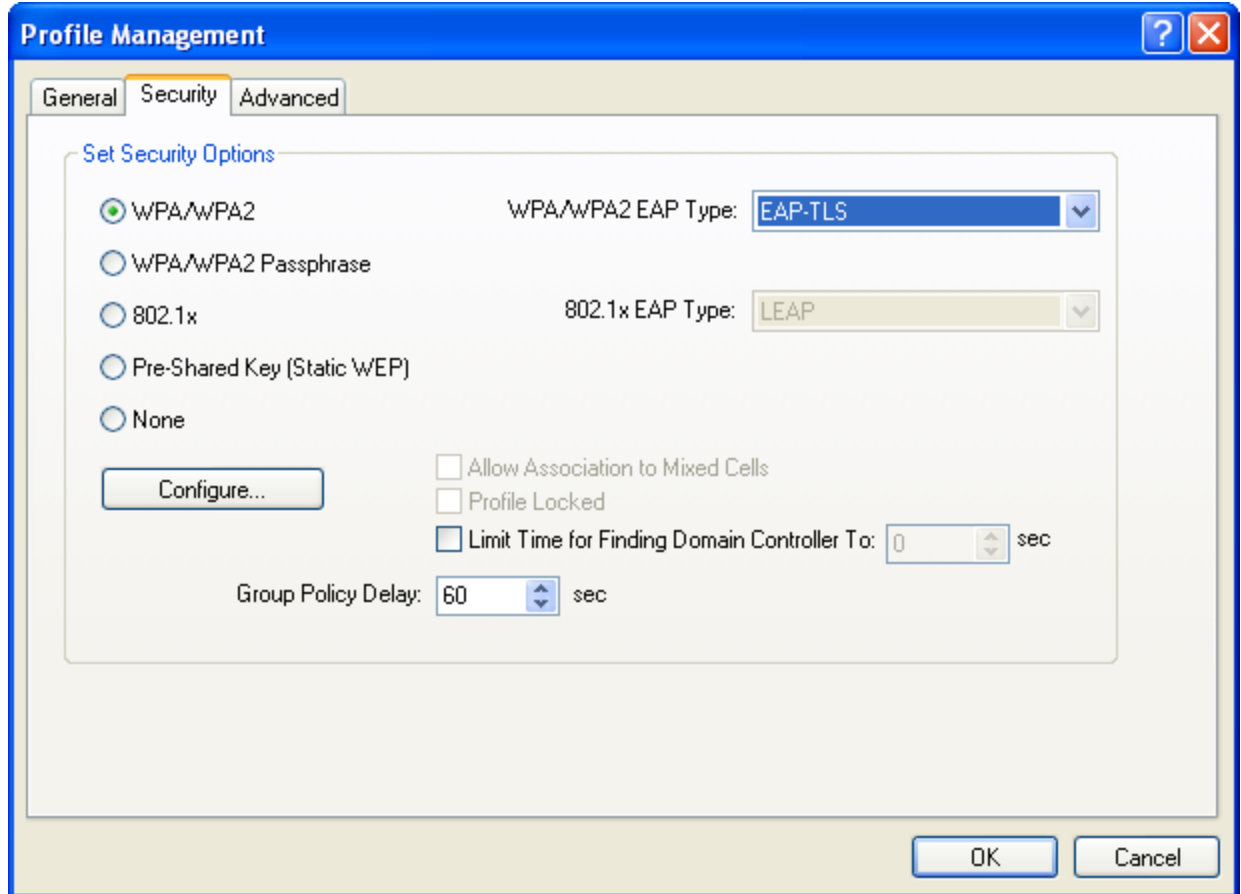

1. Select **WPA/WPA2** from **Set Security Options**.
2. Choose **EAP-TLS** from the **WPA/WPA2 EAP Type** pulldown.
3. Click the **Configure** button.

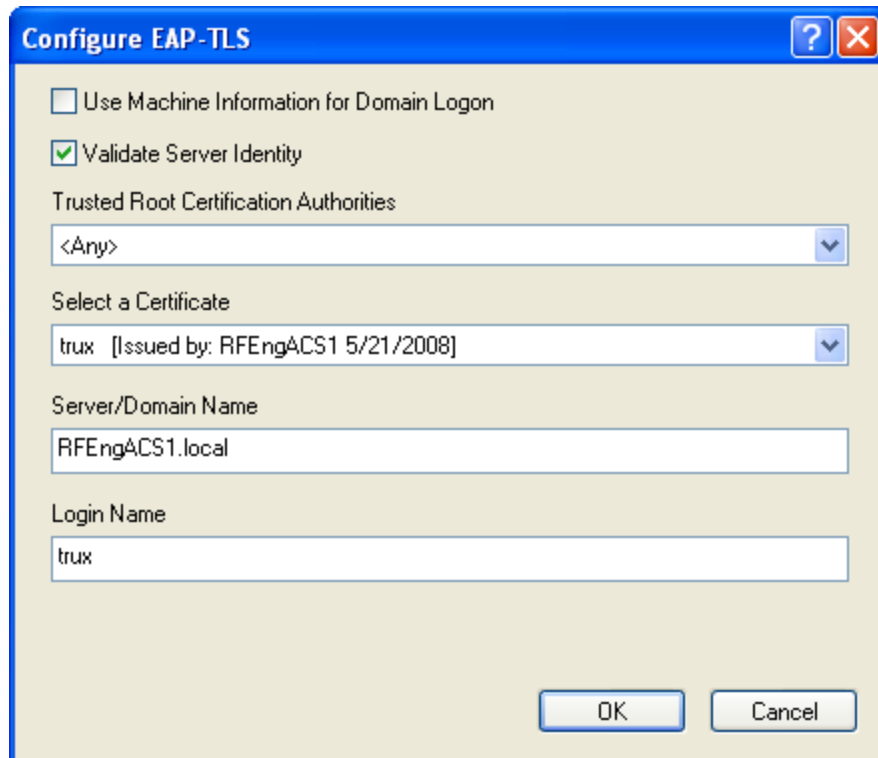

4. From the **Trusted Root Certification Authorities** pulldown, select the appropriate root certification authority.
5. From the **Select a Certificate** pulldown, select the appropriate user certificate.
6. Click **OK** to save the certificate information and then click **OK** again to save the profile.
7. Make sure the desired profile is selected on the **Profile Management** screen. Double-clicking on any profile makes that profile active.

WPA LEAP

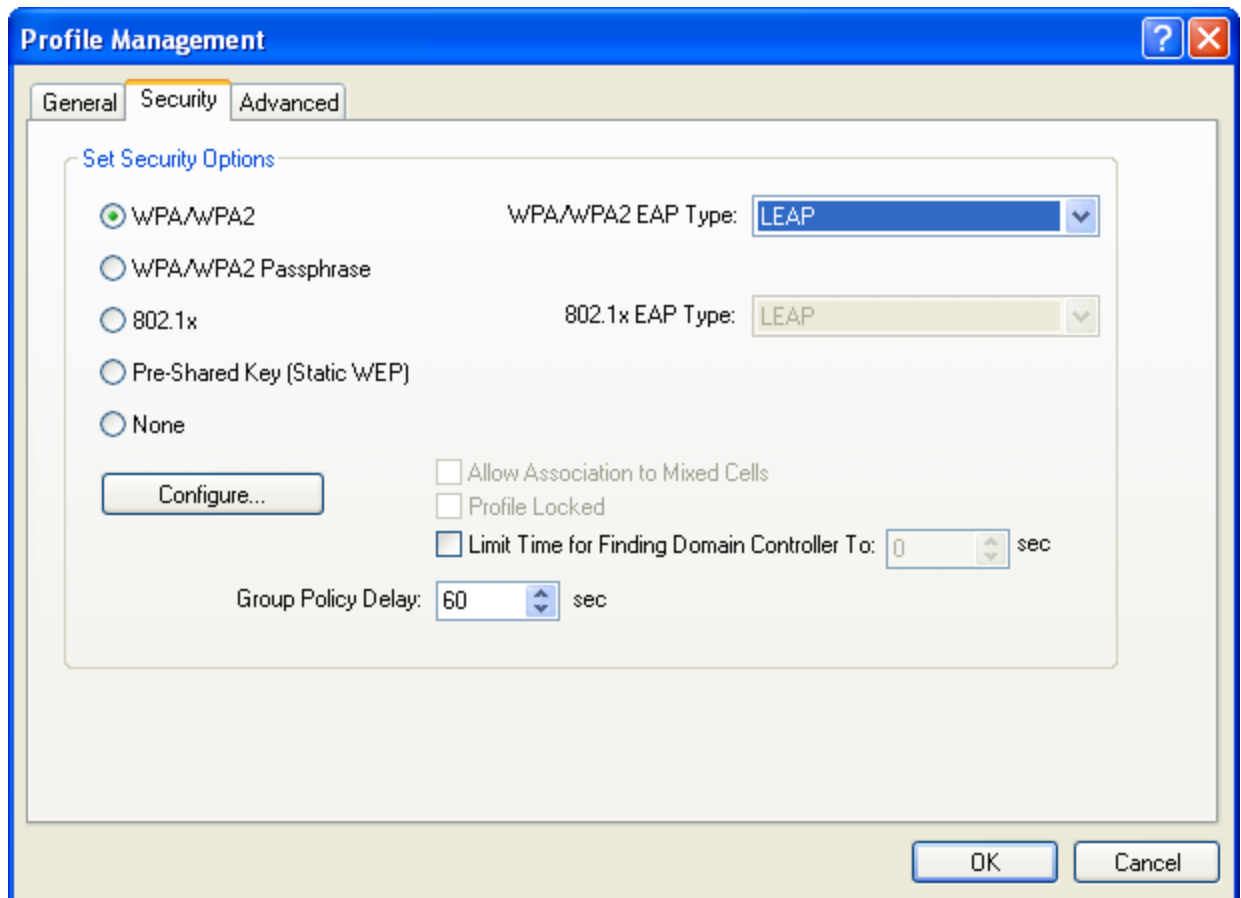

1. Select **WPA/WPA2** from **Set Security Options**.
2. Choose **LEAP** from the **WPA/WPA2 EAP Type** pulldown.
3. Click the **Configure** button.

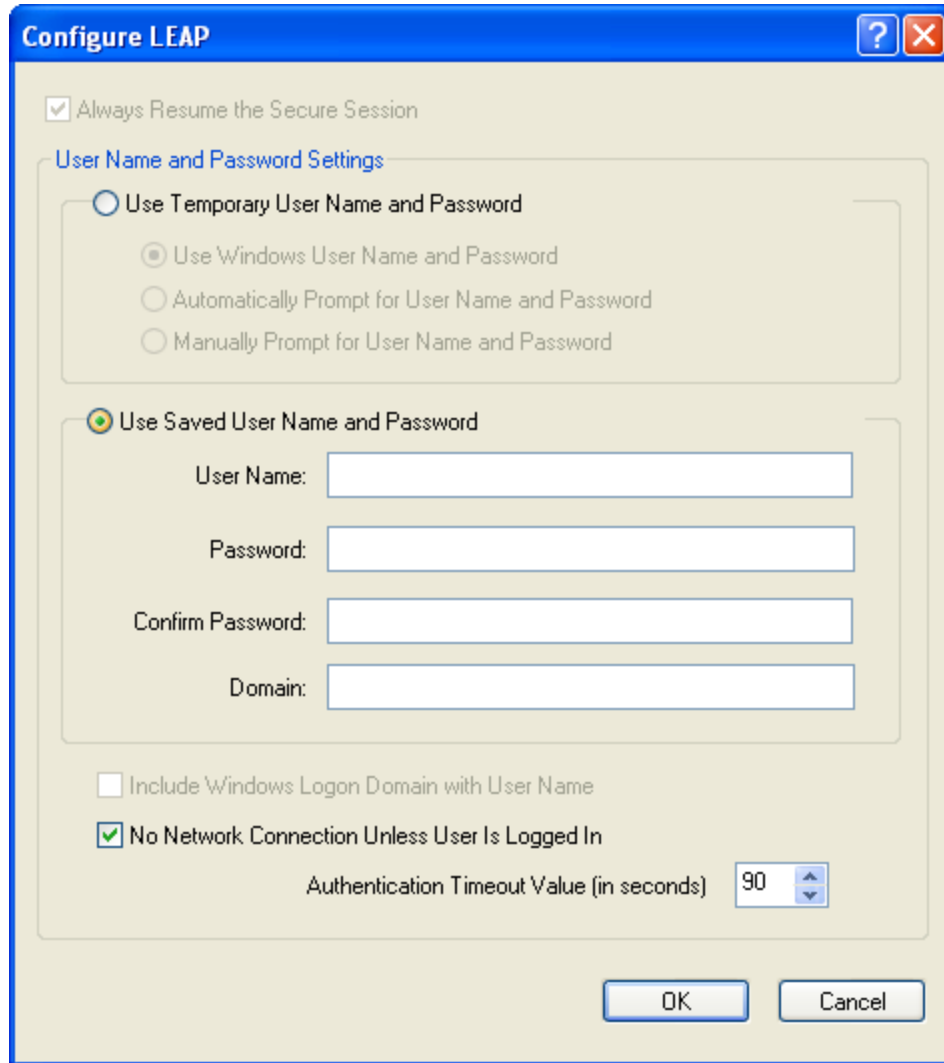

4. Make sure **Use Saved User Name and Password** is selected.
5. Enter the user credentials.
6. Click **OK** to save the credential information and then click **OK** again to save the profile.
7. Make sure the desired profile is selected on the **Profile Management** screen. Double-clicking on any profile makes that profile active.

EAP-FAST

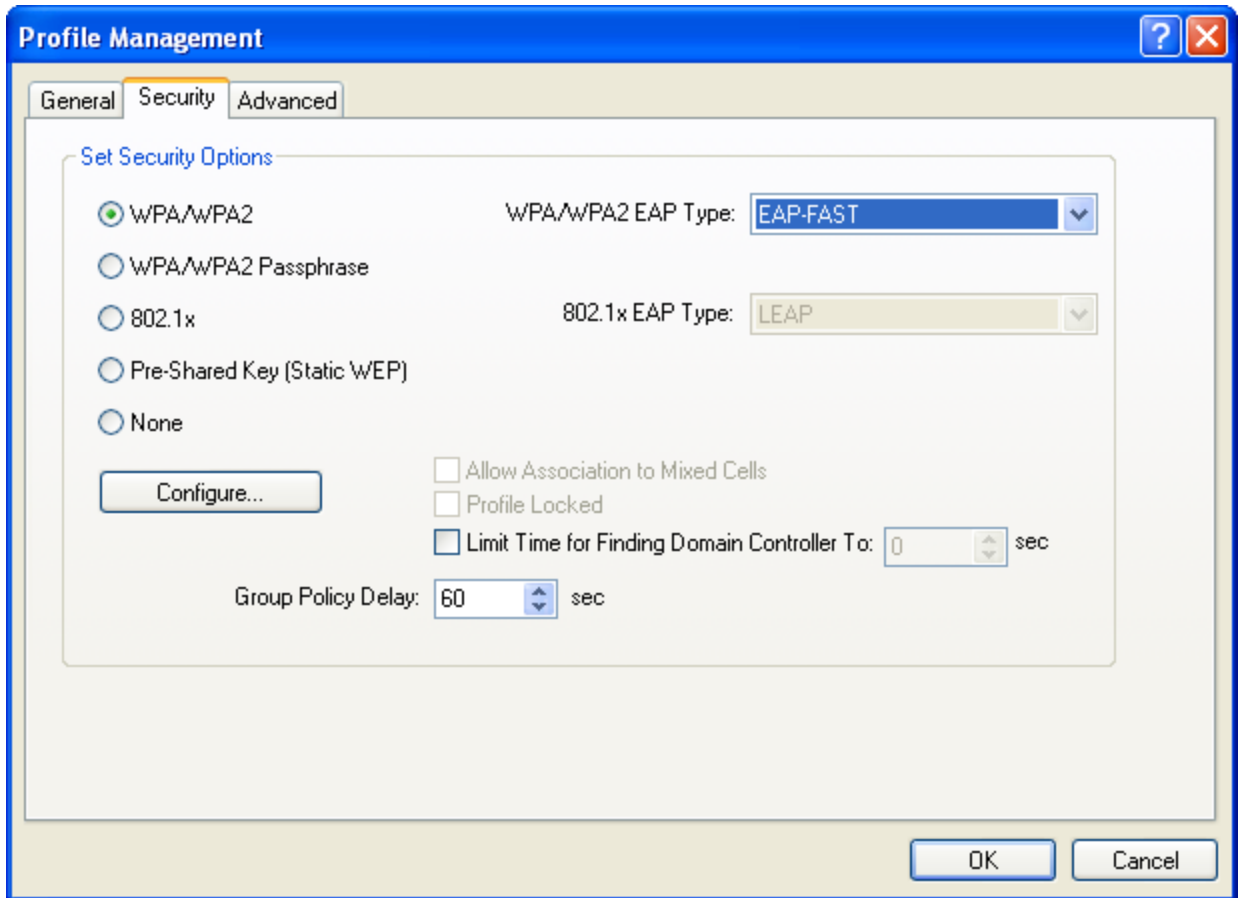

1. Select **WPA/WPA2** from **Set Security Options**.
2. Choose **EAP-FAST** from the **WPA/WPA2 EAP Type** pulldown.
3. Click the **Configure** button.

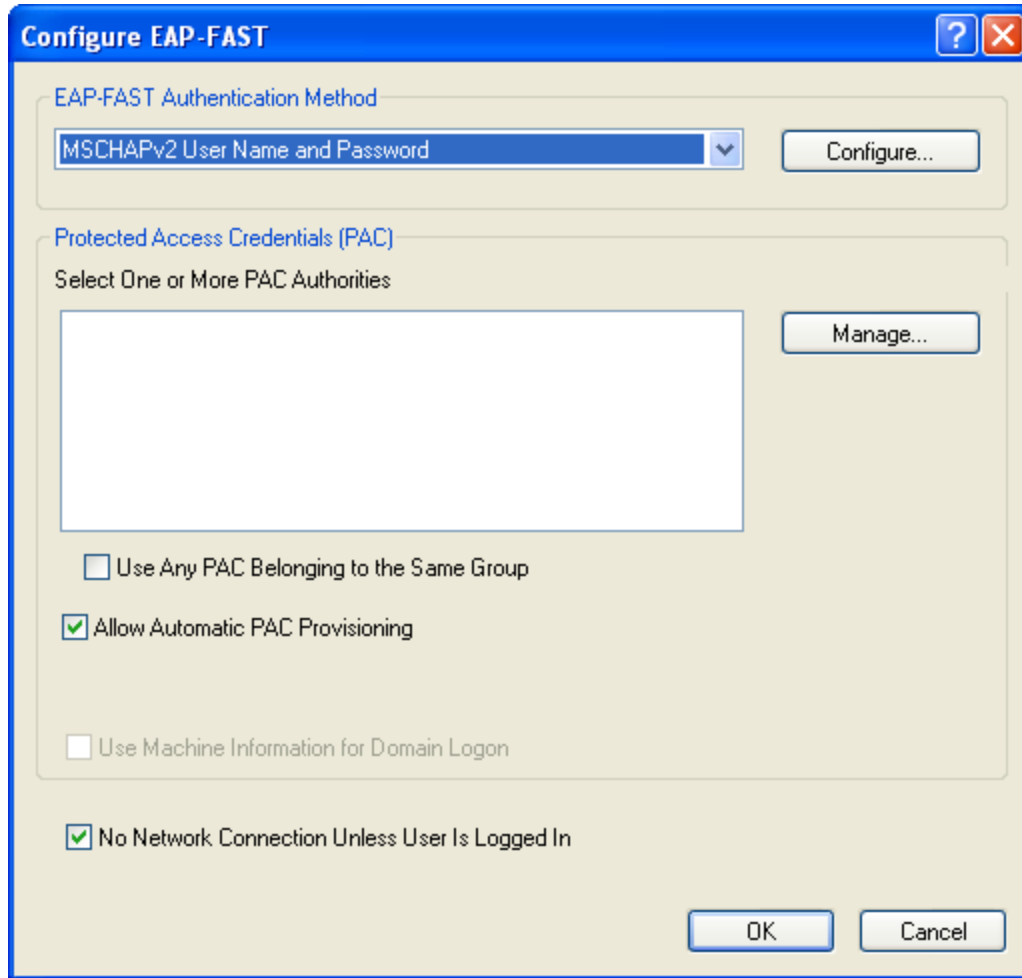

4. Select **MSCHAPv2 User Name and Password** from the **EAP-FAST Authentication Method** pulldown list.
5. Check the checkbox for **Allow Automatic PAC Provisioning**.
6. Click the **Configure** button.

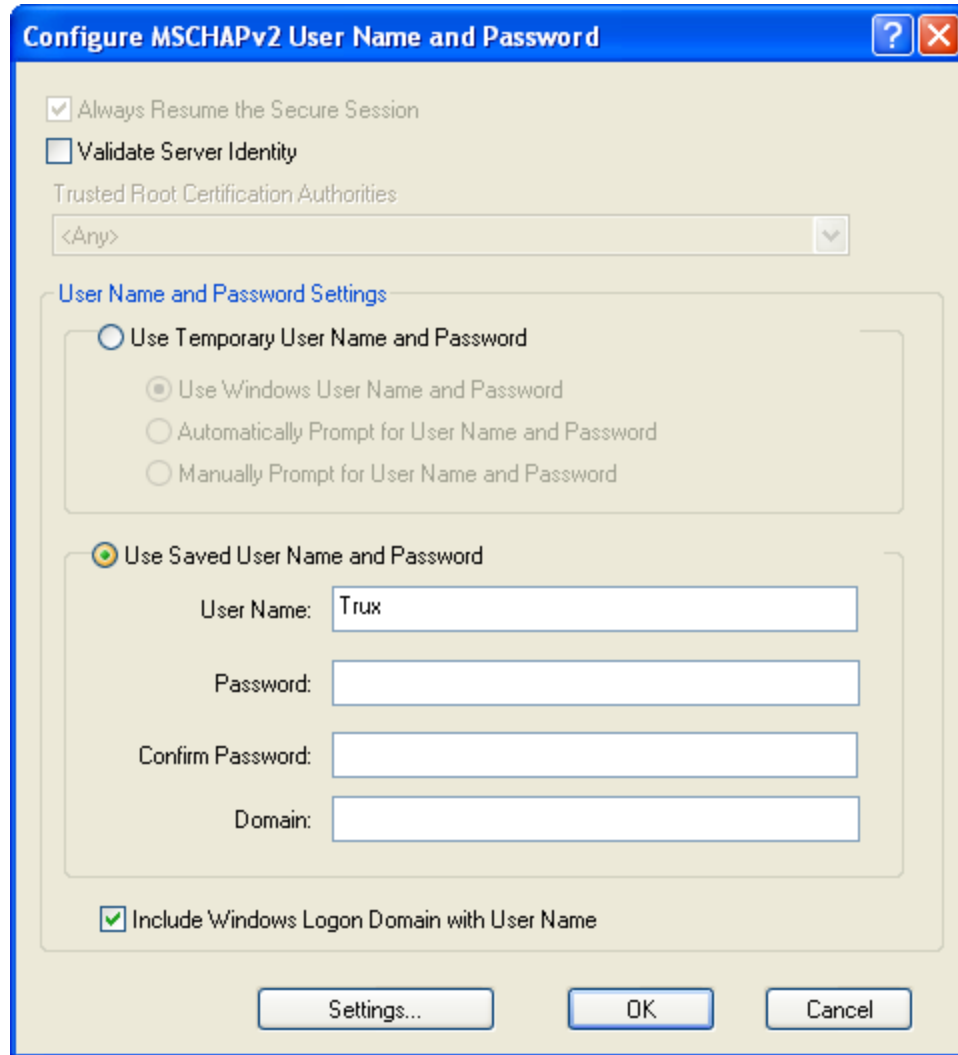

7. Make sure **Use Saved User Name and Password** is selected.
8. Enter the user credentials.
9. Click **OK** to save the credential information, click **OK** again to save the authentication information and then click **OK** again to save the profile.
10. Make sure the desired profile is selected on the **Profile Management** screen. Double-clicking on any profile makes that profile active.

Broadcom Wireless Utility - 802.11b/g Radio

- ⦿ Windows® Embedded Standard
- ◆ Windows® XP Embedded / Professional

The 802.11b/g radio is configured with the Broadcom® Wireless Utility (BWU). The BWU can be accessed by:

- Selecting **Start > All Programs > Broadcom Wireless > Broadcom Wireless Utility**
- Clicking on the **BWU** icon () in the system tray.

Wireless Zero Config

This section assumes the BWU is used to configure the radio. However, it is possible to use the Windows Wireless Zero Config (WZC) utility to configure the radio.

To use WZC to configure the radio:

- Start the BWU and select the **Wireless Networks** tab.
- Uncheck **Let this tool manage your wireless networks**.
- Click **OK**.

The Windows WZC utility can now be used to configure the radio. Please refer to the Help function in Microsoft Windows XP for more information on using Windows to configure the wireless network connection.

To return radio control to the BWU, restart the BWU and follow the on screen instructions.

Using the BWU

There are many features contained in the BWU that are not covered in this document. For more information, click the **Help** button displayed on most BWU screens.

The Wireless Network tab displays configuration options and any currently configured connection profiles. Network profiles display the type of network (infrastructure or ad hoc, the network name) and an icon if the network is secured.

To create a network profile, follow these steps:

1. Click **Add**.
2. Click **Manually connect to an advanced network**.
3. See the following section for the desired network security option.

No Security

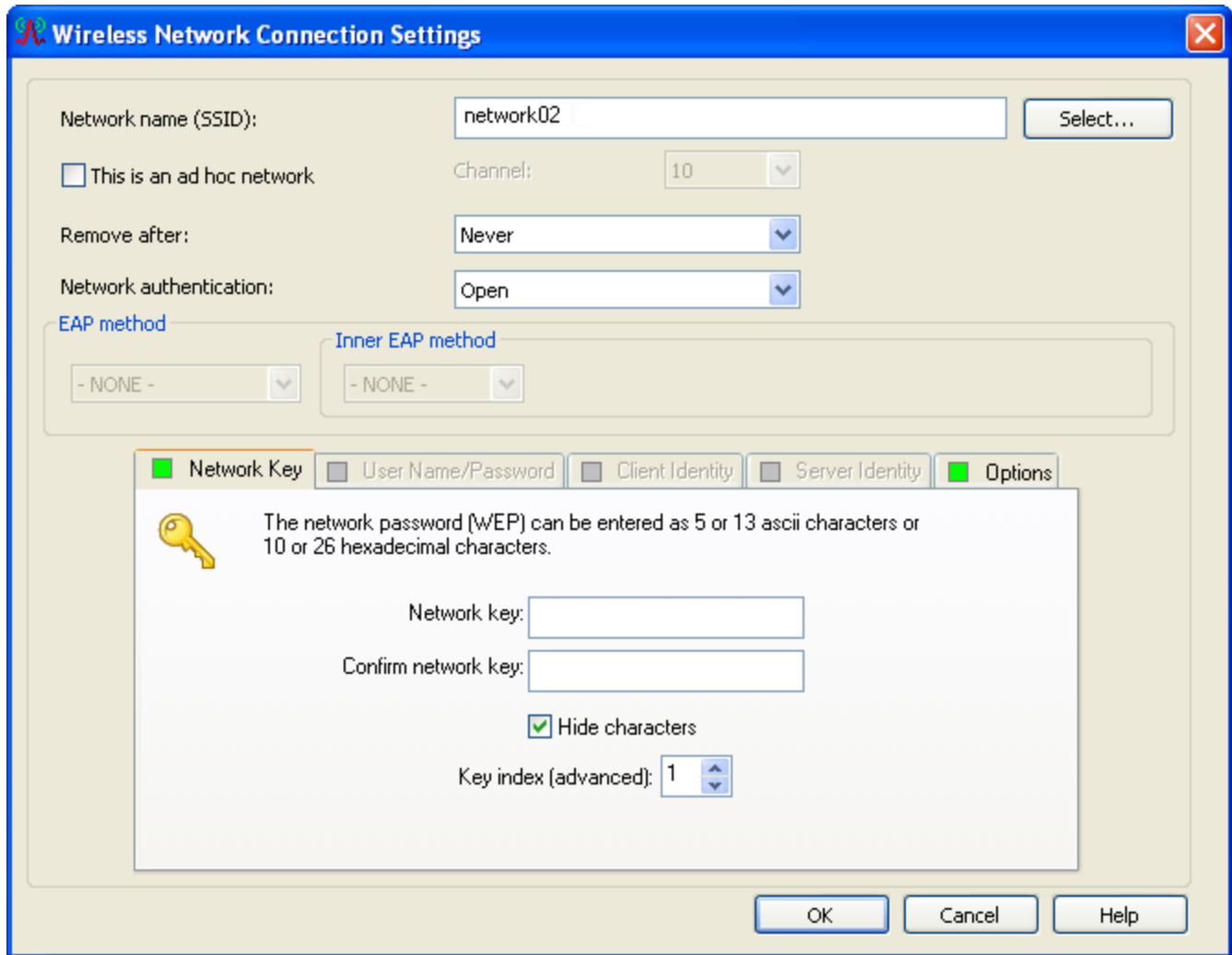

1. Enter the **Network name (SSID)**.
2. Set **Network authentication** to **Open**.
3. Click **OK** to save the profile.
4. The BWU automatically connects to the first listed profile within range. Use the Up and Down icons to adjust the list as desired.

WEP

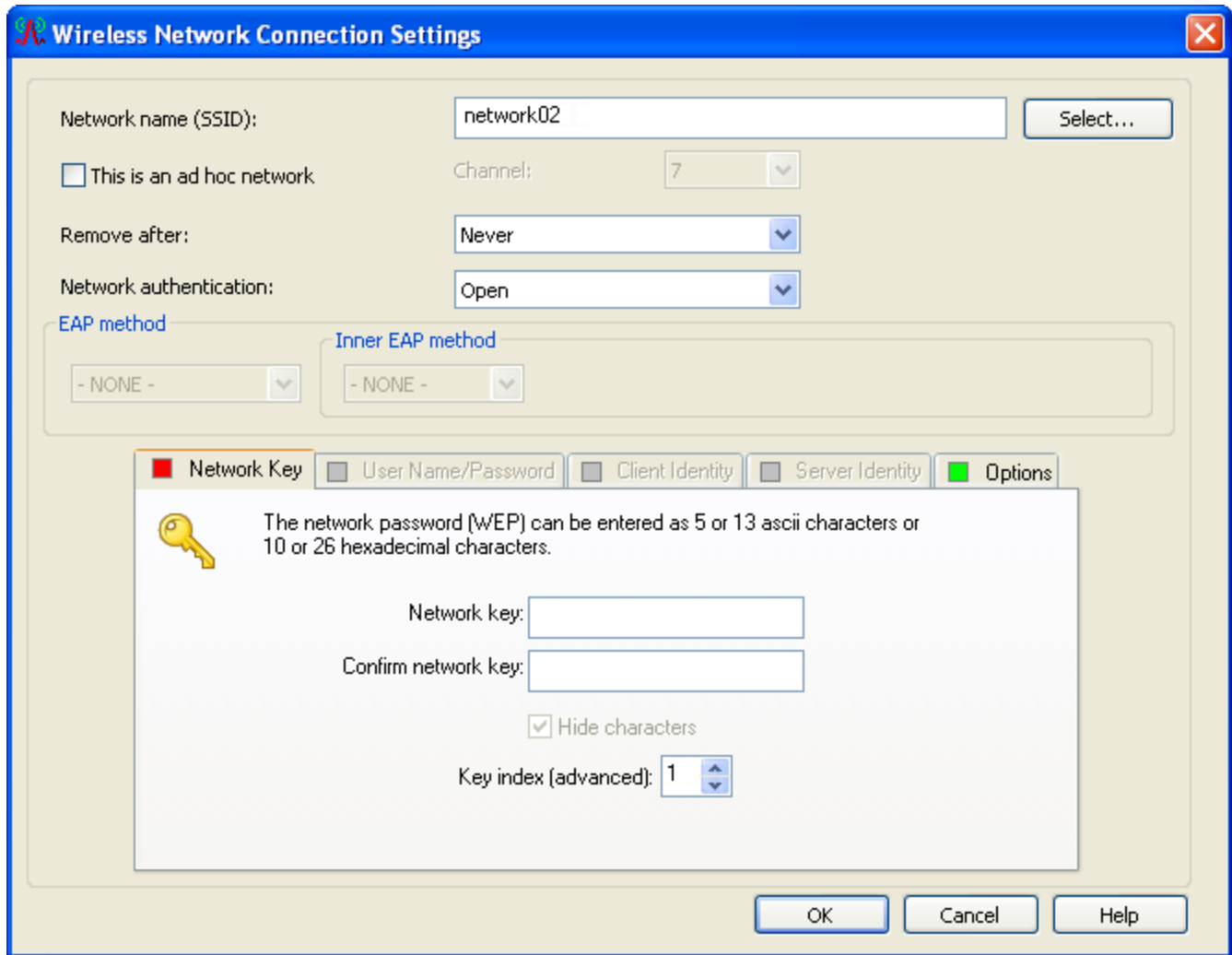

1. Enter the **Network name (SSID)**.
2. Set **Network authentication** to **Open**.
3. Enter and confirm the network key under **Network Key**.
4. Click **OK** to save the profile.
5. The BWU automatically connects to the first listed profile within range. Use the Up and Down icons to adjust the list as desired.

LEAP

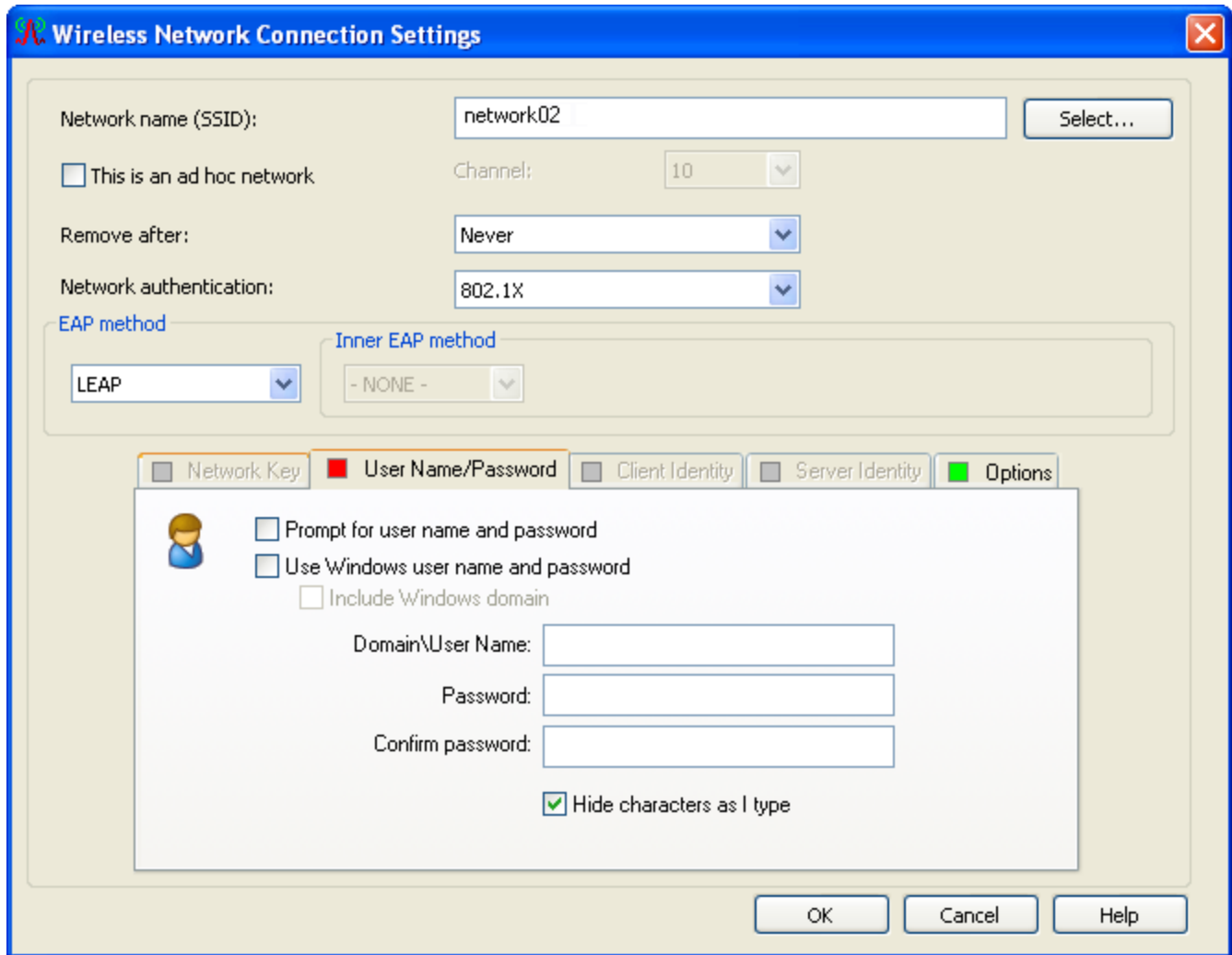

1. Enter the **Network name (SSID)**.
2. Set **Network authentication** to **802.1X**.
3. Select **LEAP** from the **EAP method** pulldown list.
4. Enter the user credentials and confirm the network password under **User Name/Password**.
5. Click **OK** to save the profile.
6. The BWU automatically connects to the first listed profile within range. Use the Up and Down icons to adjust the list as desired.

WPA-PSK

Wireless Network Connection Settings

Network name (SSID):

This is an ad hoc network

Channel:

Remove after:

Network authentication:

EAP method:

Inner EAP method:

Network Key User Name/Password Client Identity Server Identity Options

The Wi-Fi Protected Access password must have between 8 and 63 characters.

Network key:

Confirm network key:

Hide characters

Key index (advanced):

1. Enter the **Network name (SSID)**.
2. Set **Network authentication** to **WPA-Personal (PSK)**.
3. Enter and confirm the network key under **Network Key**.
4. Click **OK** to save the profile.
5. The BWU automatically connects to the first listed profile within range. Use the Up and Down icons to adjust the list as desired.

PEAP/MS-CHAP

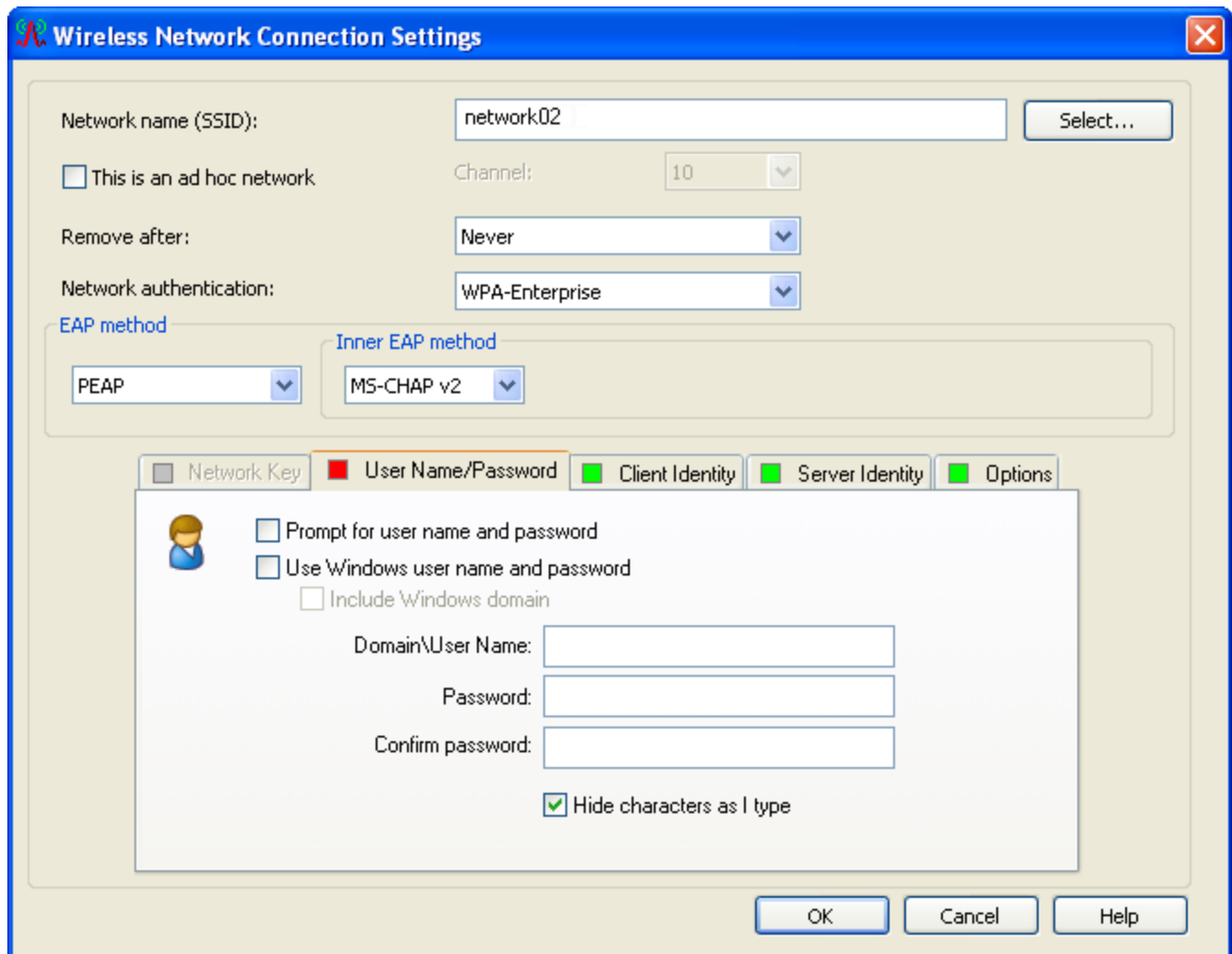

1. Enter the **Network name (SSID)**.
2. Set **Network authentication** to **WPA-Enterprise**.
3. Select **PEAP** from the **EAP method** pulldown list.
4. Select **MS-CHAP v2** from the **Inner EAP method** pulldown list.
5. Enter the user credentials and confirm the network password under **User Name/Password**.
6. Click **OK** to save the profile.
7. The BWU automatically connects to the first listed profile within range. Use the Up and Down icons to adjust the list as desired.

PEAP-GTC

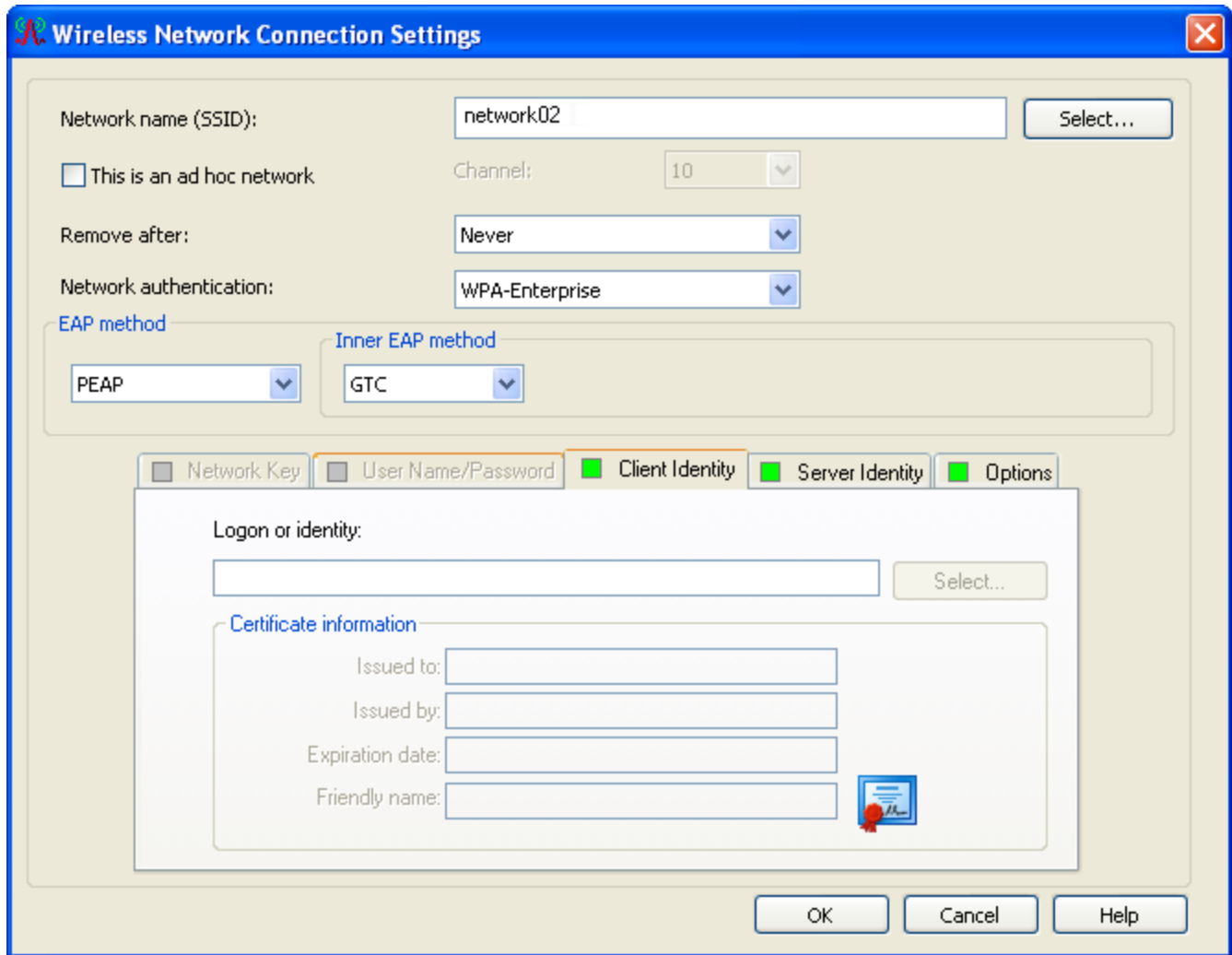

1. Enter the **Network name (SSID)**.
2. Set **Network authentication** to **WPA-Enterprise**.
3. Select **PEAP** from the **EAP method** pulldown list.
4. Select **GTC** from the **Inner EAP method** pulldown list.
5. Enter the appropriate token username for **Logon or identity** under Client Identity.
6. Click **OK** to save the profile.
7. The BWU automatically connects to the first listed profile within range. Use the Up and Down icons to adjust the list as desired.

EAP-TLS

EAP-TLS requires that appropriate server and user certificates are installed on the Thor VX8 computer. Please refer to [Certificates](#) for details.

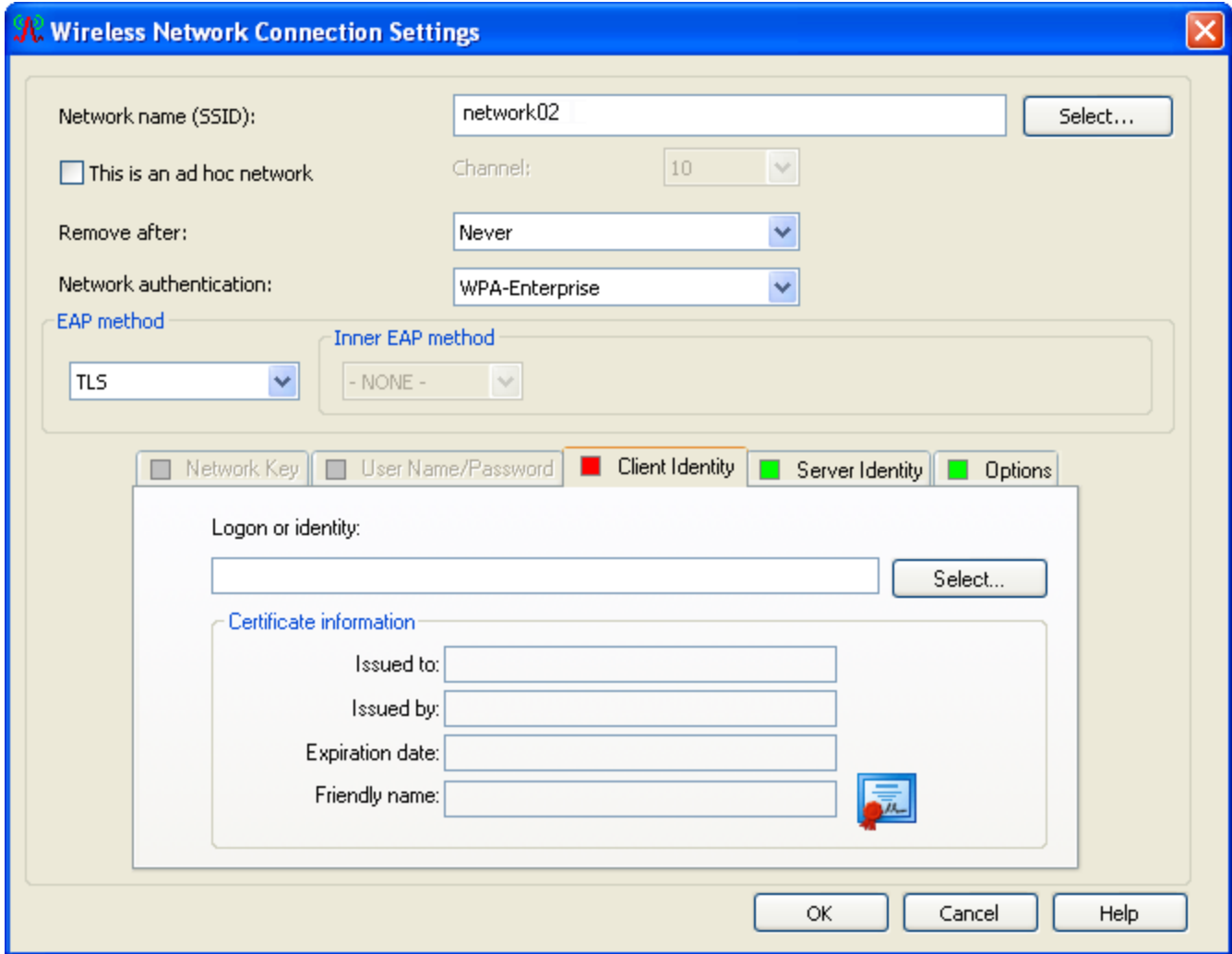

1. Enter the **Network name (SSID)**.
2. Set **Network authentication** to **WPA-Enterprise**.
3. Select **TLS** from the **EAP method** pulldown list.
4. Under **Client Identity**, use the **Select** button to browse for the user certificate.
5. Click on **Server Identity**.

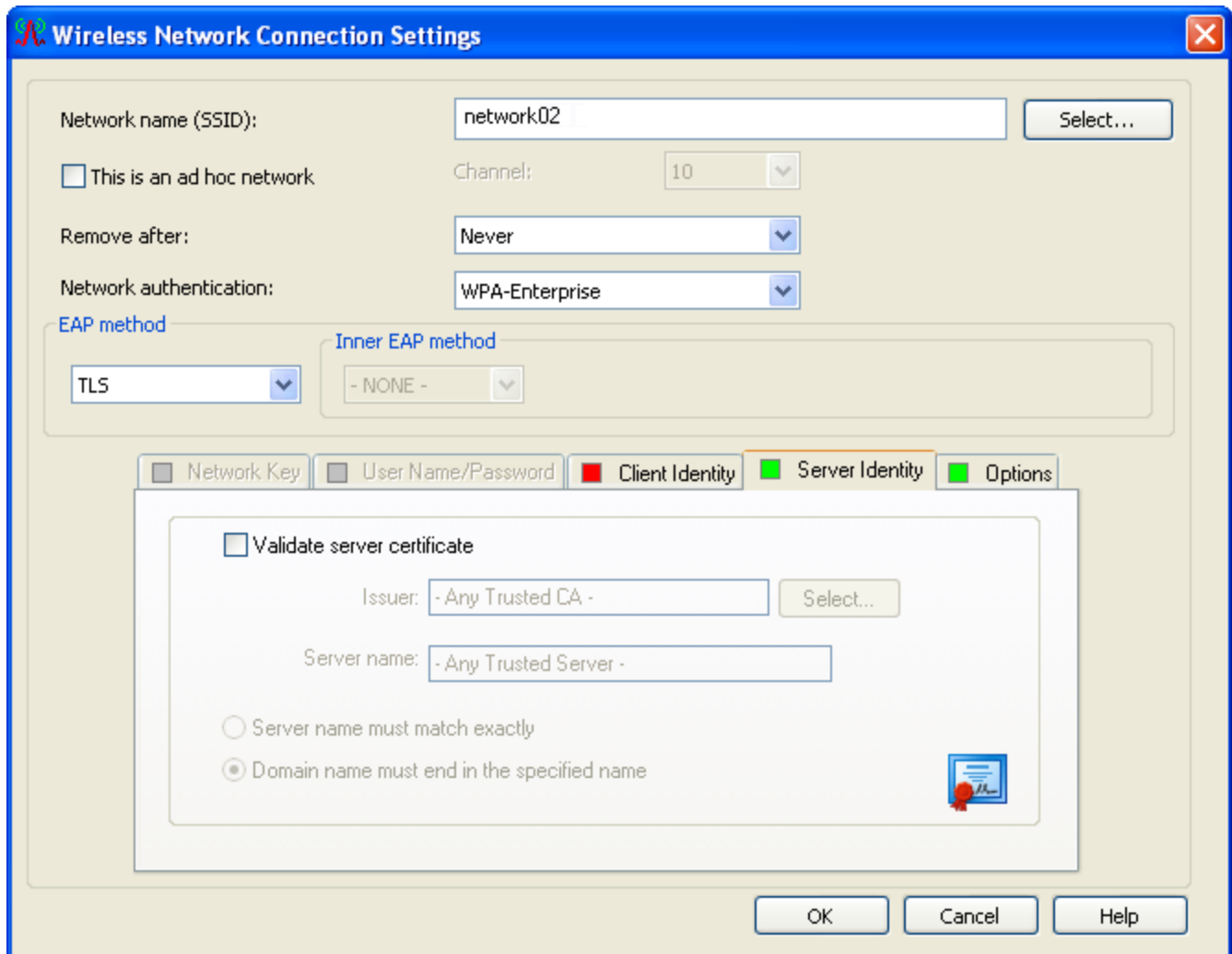

6. Check to box to **Validate server certificate**.
7. Use the **Select** button to browse for the server certificate
8. Click **OK** to save the profile.
9. The BWU automatically connects to the first listed profile within range. Use the Up and Down icons to adjust the list as desired.

WPA LEAP

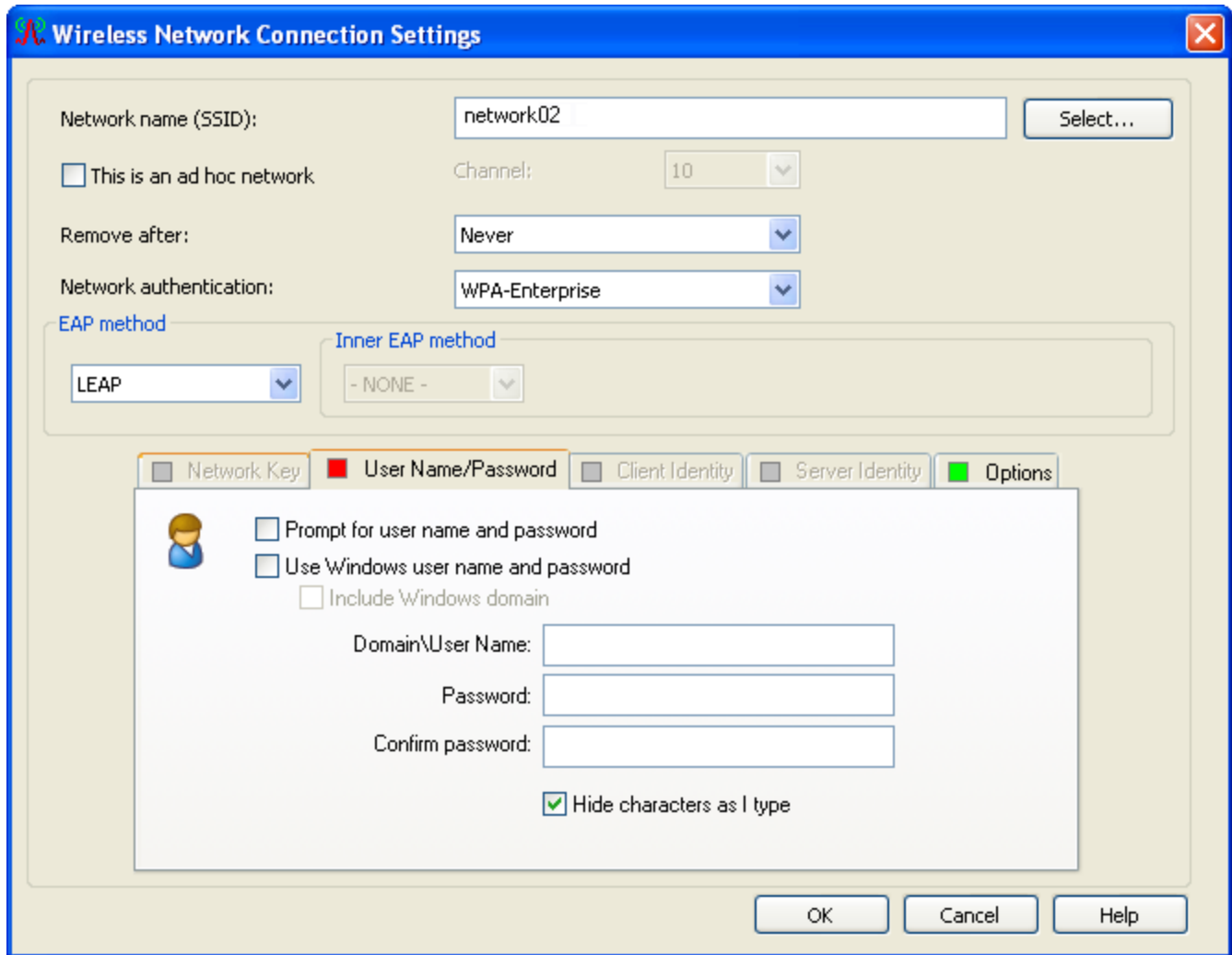

1. Enter the **Network name (SSID)**.
2. Set **Network authentication** to **WPA-Enterprise**.
3. Select **LEAP** from the **EAP method** pulldown list.
4. Enter the appropriate user credentials and confirm the password under **User Name/Password**.
5. Click OK to save the profile.
6. The BWU automatically connects to the first listed profile within range. Use the Up and Down icons to adjust the list as desired.

EAP-FAST

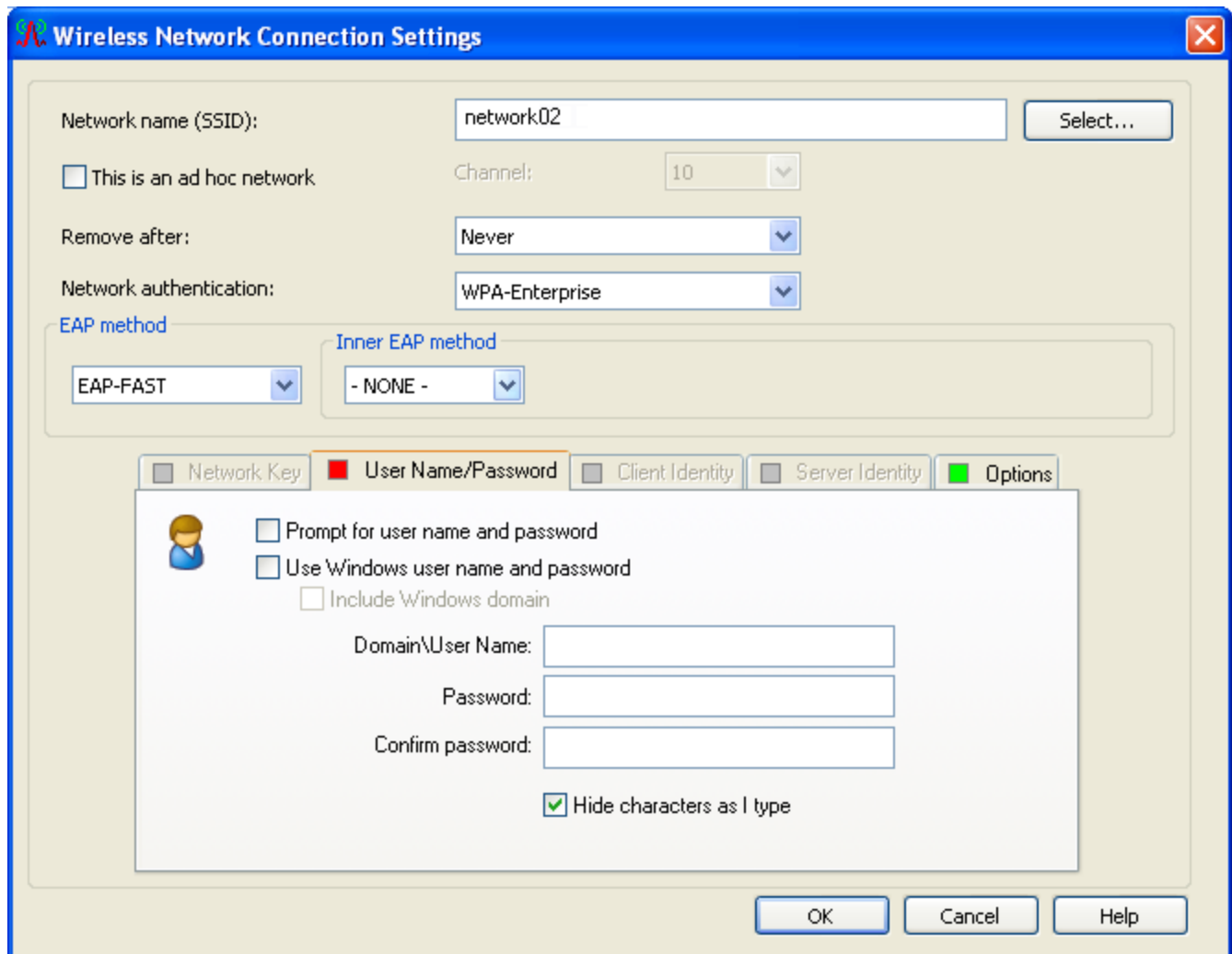

1. Enter the **Network name (SSID)**.
2. Set **Network authentication** to **WPA-Enterprise**.
3. Select **EAP-FAST** from the **EAP method** pulldown list.
4. Enter the appropriate user credentials and confirm the password under **User Name/Password**.
5. Click **OK** to save the profile.
6. The BWU automatically connects to the first listed profile within range. Use the Up and Down icons to adjust the list as desired.

Certificates

In order to authenticate with EAP-TLS, the user needs to have the appropriate server and user certificates installed on the device.

1. Log into the Certificate Authority webpage.

Microsoft Certificate Services -- johndoe

[Home](#)

Download a CA Certificate, Certificate Chain, or CRL

To trust certificates issued from this certification authority, [install this CA certificate chain](#).

To download a CA certificate, certificate chain, or CRL, select the certificate and encoding method.

CA Certificate:

Current [johndoe]

Encoding method:

- DER
 Base 64

[Download CA certificate](#)

[Download CA certificate chain](#)

[Download latest base CRL](#)

[Download latest delta CRL](#)

-
2. Click on **Download a CA certificate, certificate chain, or CRL**.
 3. Click on **install this CA certificate chain**.
 4. Go back to the main page.
 5. Click on **Request a certificate**.
 6. Click on **User Certificate**.

Request a Certificate

Select the certificate type:

[User Certificate](#)

Or, submit an [advanced certificate request](#).

7. Click **Submit**.
8. Click **Yes** on the pop up to request a certificate.

Bluetooth

The Bluetooth control panel can be accessed either by clicking the Bluetooth icon in the taskbar or by clicking on the Bluetooth Devices option in the Windows control panel.

8650 Bluetooth Ring Scanner/Imager

Use the Bluetooth Device Wizard in the Microsoft Windows Control Panel to discover and manage the Bluetooth scanner connection.

Do not use the ComponentSoft wedge software (provided with the 8650 series Bluetooth Ring Scanners) on the Thor VX8.

Devices Tab

The Devices tab displays any previously discovered Bluetooth devices.

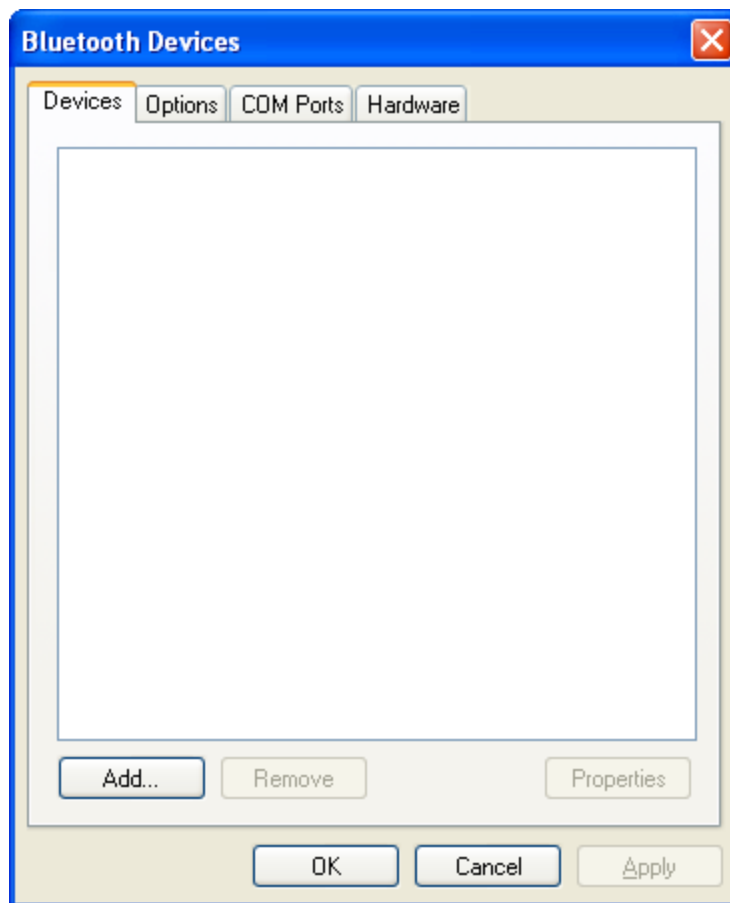

If there are no Bluetooth devices shown or if the desired device is not shown, use the Add Bluetooth Device Wizard to discover Bluetooth devices.

Click the Add button to start the wizard.



The wizard cannot be started until the checkbox indicating the device is set up and ready to be found is checked. If any Bluetooth devices are discovered, they are displayed.

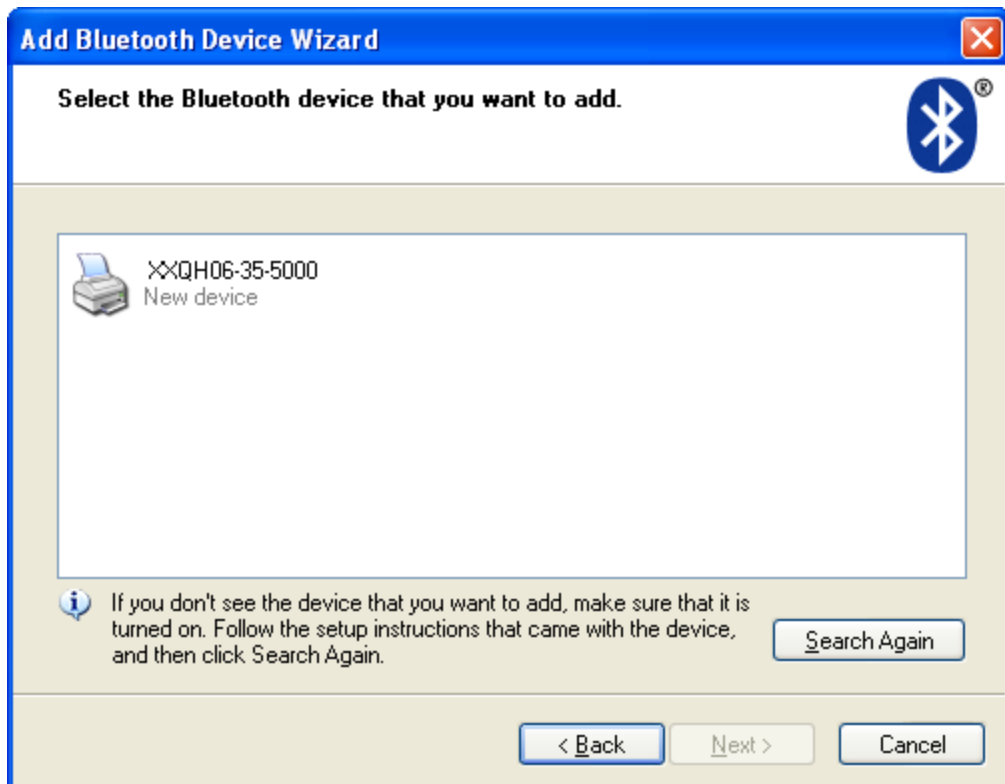

Select the desired Bluetooth device and click Next.

Select the appropriate passkey option.

The Bluetooth device is ready to use.

Options Tab

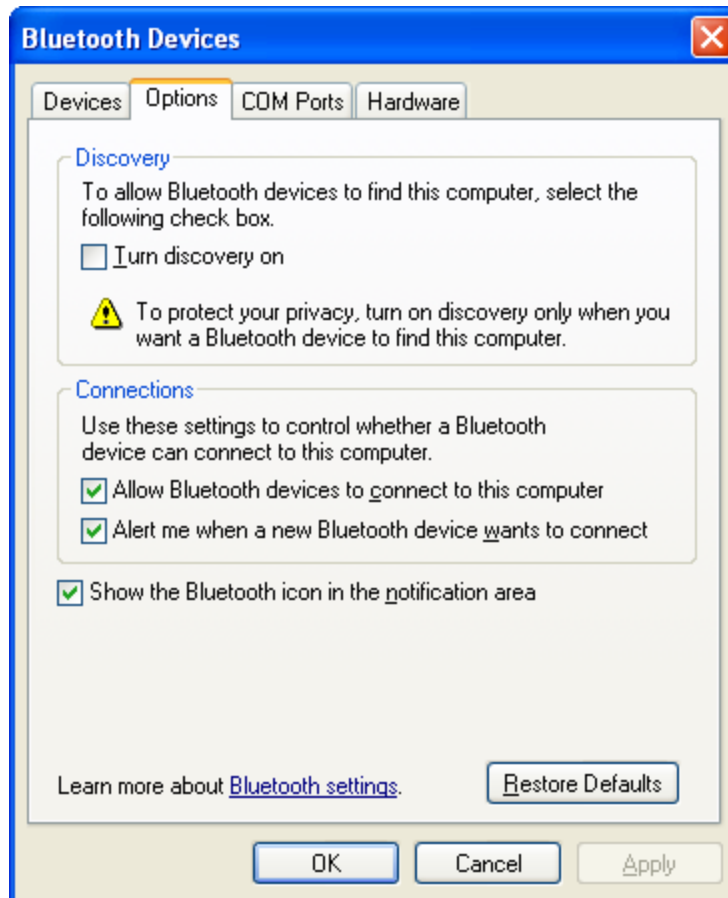

This tab contains various Bluetooth connection options. More information can be found using Help and Support on the Windows Start menu.

COM Ports Tab

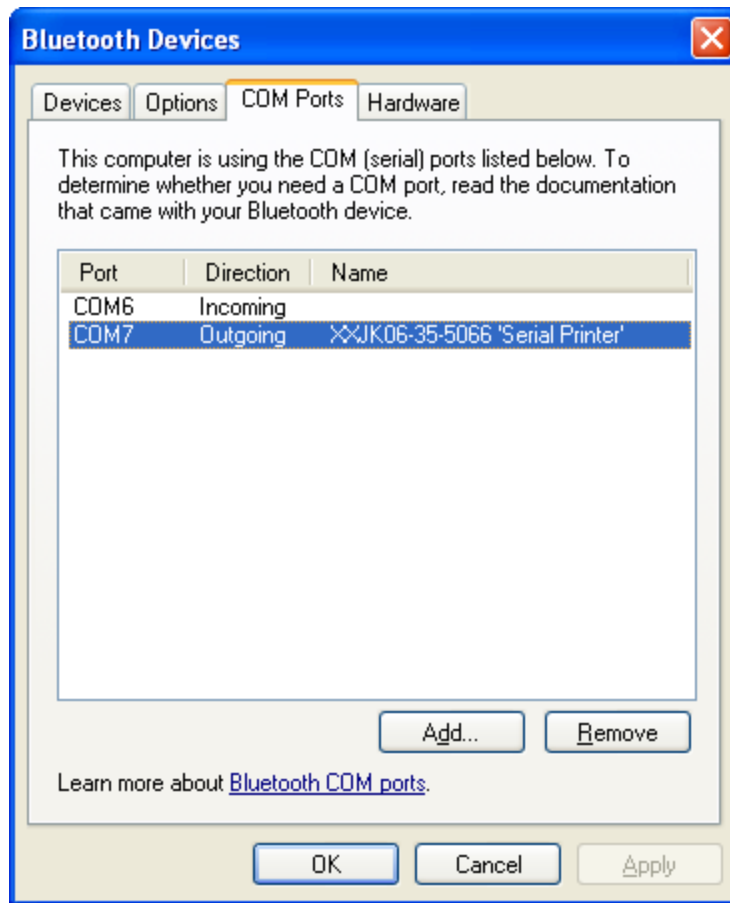

This tab displays the COM ports used by Bluetooth devices, such as the Bluetooth printer illustrated. More information can be found using Help and Support on the Windows Start menu.

Hardware Tab

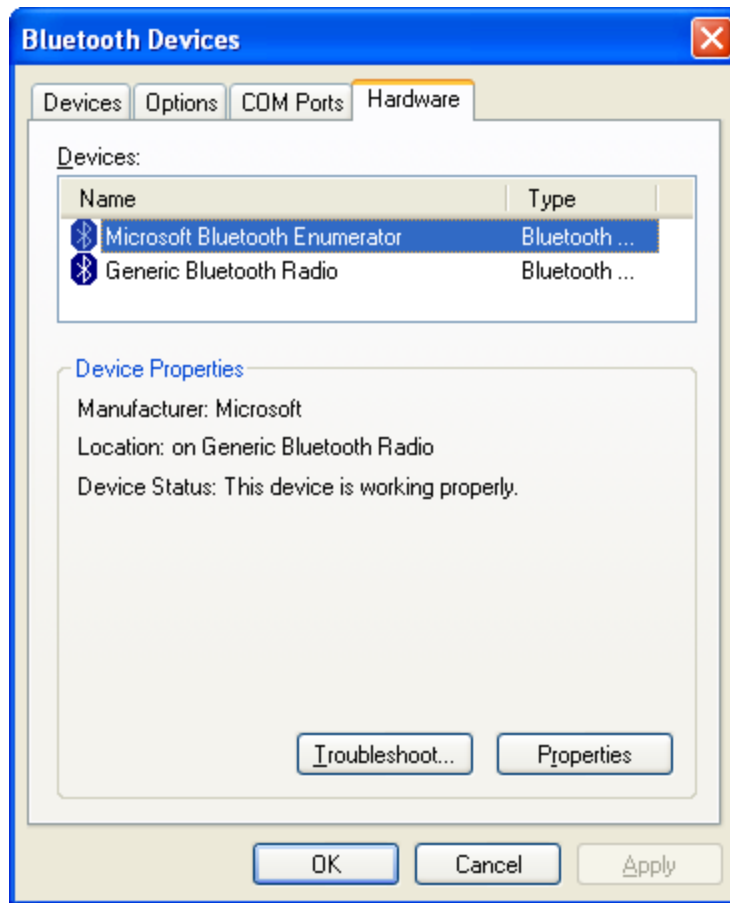

This tab hardware information for Bluetooth. More information can be found using Help and Support on the Windows Start menu.

SIM card installation

Read through these installation instructions before commencing assembly.



Connect the supply cable only when everything else has been assembled.

This document describes the process of inserting a SIM card into the PCCard of your Thor VX8 computer.

Requirements

In order to perform this operation you need the following:

- Torx 20 screwdriver.
- SIM card from your network operator.

Installation

The following procedure describes how to insert a SIM card:

1. Place the Thor VX8 upside down onto a flat clean surface.
2. Remove the service hatch by loosening the 2 torx screws.



3. Remove the antenna pigtail from the GPRS/EDGE/3G PCCard.
4. Remove the GPRS/EDGE/3G PCCard by pressing the PCCard eject button.

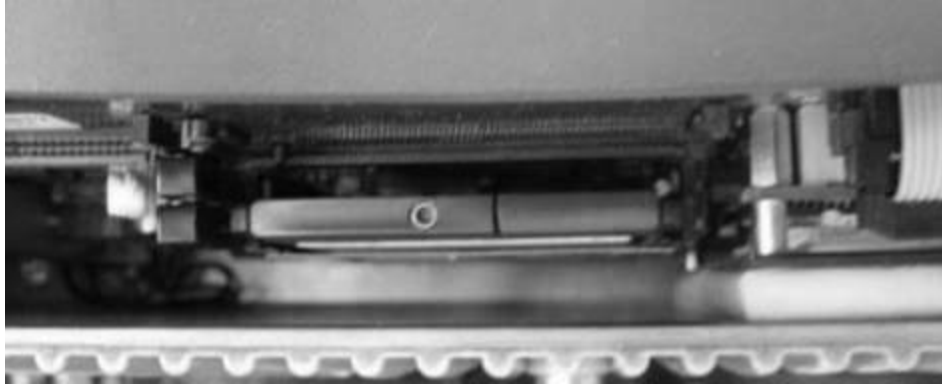

5. Insert your SIM card into the PCCard as shown below.



6. Reinsert the PCCard into the PCCard socket.
7. Reattach the antenna pigtail.
8. Reattach the service hatch.
9. Start the computer.

Option GlobeTrotter Connect

SIM Card PIN

If you have not already installed a SIM card, [install the SIM card](#) now.

If you have PIN-code enabled you will be prompted to type the code at startup.

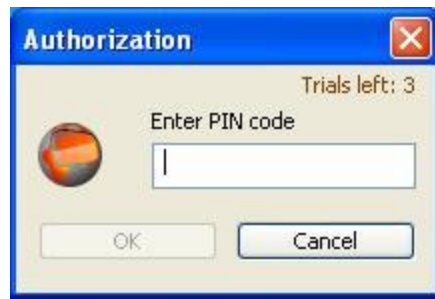

Using Option GlobeTrotter Connect

1. Double-click the gray/green Option icon in the system tray to launch the application



2. For some operators the application is automatically configured for the network, if not configure the settings as advised by your local operator



3. When all settings are made press the connect button to connect to the preferred network. To disconnect, press Disconnect.



OneClick Internet

This section contains the User Manual for the customized version of WebToGo's OneClick Internet for the Honeywell Thor VX8.

OneClick Internet is installed by Honeywell on all Thor VX8s equipped with a WWAN radio. Available carriers and OneClick features may vary by device.

OneClick Internet provides:

- Internet connection management
- Email download
- Contact management for SIM and Microsoft Outlook

Since WebToGo OneClick Internet is preinstalled, it is present on the Windows Start Menu. A desktop icon is also provided.



Honeywell does not recommend using standby on the Thor VX8 while the WWAN connection is active. When exiting standby, a delay of one minute or more may occur as the WWAN radio reads firmware files and initializes before reconnecting. If this delay is acceptable to the user, standby may be enabled.

Preparing for Initial Use on the Thor VX8

Install SIM Card

If using a CDMA carrier such as Verizon, skip this step because a SIM card is not used.

[Install a SIM card](#) in the Thor VX8.

Load Firmware

While the OneClick Internet utility is preinstalled, it is necessary to load the GOBI radio firmware for your selected carrier such as AT&T, T-Mobile or Verizon.

Note: The firmware may automatically be selected when a SIM card is installed in the Thor VX8.

Double-tap the OneClick Internet icon on the Thor VX8 desktop.



OneClick
Internet

Tap the **Settings** button and select the **Firmware** tab. Select the firmware for your carrier from the list and tap **Change**.

For more details, see [OneClick Internet Connection Manager](#) and the [Firmware tab](#).

Activation

This step is only necessary for Verizon.

The activation screen is displayed automatically after the Verizon firmware is selected. If the activation screen is not automatically displayed, double-tap the **OneClick Internet** icon on the desktop. Select **Settings > General** tab and tap the **Activate** button.



Make sure **Automated Activation** is selected and tap **Next**.



Tap **Next** to complete the activation.

Once the activation is completed, OneClick Internet may be minimized to the tray.

🔊 To verify your settings, tap on the OneClick Internet icon in the system tray.

Tap **Settings**.

Tap the **Network** tab.

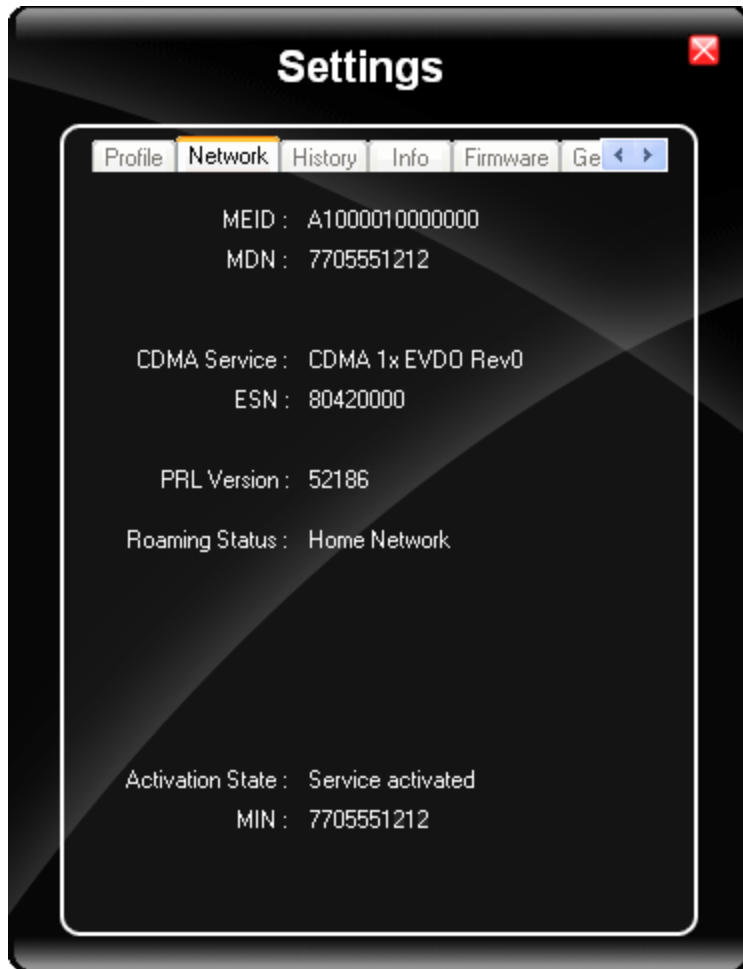

This screen contains the settings including the telephone number from the provider, in this case Verizon.

Using OneClick Internet

If OneClick Internet is not loaded, double-tap the desktop icon to load it. If OneClick Internet is loaded but minimized to the system tray, tap the OneClick Internet icon in the system tray to maximize it.

Connection Management

1. Launch the OneClick Internet Connection Manager and wait until the status icon is **Blue** indicating ready.
2. If there is a problem, verify the SIM card is installed (AT&T, T-Mobile only), the proper firmware has been loaded, etc.
3. If Pin security is used, a popup window prompts for the SIM PIN.
4. Create a connection profile on the **Settings** menu.
5. Tap the **Connect** button.



The signal strength is indicated as well as the name of the mobile network you are using.

The screen also indicates the status of the device and the connection signal strength.

Menu Buttons

Radio Button

 The Radio button allows you to switch the WWAN radio on and off to save power or to disable the radio in instances where it is not desired (such as during airplane travel).

When the radio is switched off, the button is red. When on, it is green. If the radio is disabled by a hardware switch or if the device is not available, the button is disabled and is light gray/white.

Statistics Button

 The Statistics area provides advanced information about the connection. Values displayed are approximate.

Tap the **Statistics** button to enable the statistics viewing area, which is below the main area. When the statistics are displayed, tapping the **Statistics** button again hides the statistics viewing area.



Data In:	6.3 KB	Speed:	0 Kbps
Data Out:	0.8 KB	Max. Speed:	0 Kbps
Total:	9.5 KB	Time:	0:03:53

Data In:	The amount of data received during the current connection.
Data Out:	The amount of data sent during the current connection.
Total:	The total amount of data transferred during the current connection.
Speed:	The current data transfer rate.
Max. Speed:	The maximum data transfer rate during this connection.
Time:	The duration of the current connection.

Update Button

 One Click Internet provides a built-in online update functionality that allows for an automatic update of OneClick Internet application, device drivers, and APN database.

Honeywell **DOES NOT** recommend using this option. Contact your [representative](#) for information on upgrading to another version of OneClick Internet.

The update is triggered by pressing the update button. The application will check the WebToGo server, if updates are available, and offer them for download if suitable.

In order to start the update, select a file from the list of available updates and tap **OK**.

Help Button

 OneClick Internet includes online help that can be accessed by tapping the Help button.

Settings Button



Access the Settings menu by tapping the Settings button on the main window.

The following tabs are available:

- Profile
- Network
- History
- PIN
- Info
- Firmware
- General

Profile Tab





The screenshot shows a 'Settings' window with a red close button in the top right corner. Below the title bar is a tabbed interface with tabs for 'Profile', 'Network', 'History', 'PIN', 'Info', and 'Firmw'. The 'Profile' tab is selected. The form contains the following fields and options:

- Profile Name: [Text input field]
- APN: [Text input field]
- Username: [Text input field]
- Password: [Text input field]
- Use automatic DNS-settings
- Use Proxy Server
- Proxy: [Text input field]
- Port: [Text input field]

On the right side of the form, there is a vertical stack of four icons: a document, a document with a pencil, a document with an 'X', and a document with a checkmark. At the bottom of the form is a 'Set Profile' button.

Create a connection profile to store connection information. Once a profile has been created, its name appears in the drop down Profiles list, which replaces the Profile Name textbox in the illustration above.

Buttons

Button	Description
	Create a new profile. When this option is selected, the Profile Name is a text box. Enter a name for the profile as well as other connection specific configuration. When finished, tap the Save button to save the new profile.
	Edit a current profile. Select a profile from the Profiles list and tap this button to edit the profile parameters. When finished, tap the Save button to save the profile changes.
	Delete a profile. Select a profile from the Profiles list and tap this button to delete the profile
	Save a profile. Save a new profile or save changes made when editing a profile.
	Set Profile. Select a profile from the Profiles list and tap this button to make it the active profile used for connection.

Parameters

Label	Description
Profile Name	Profile name - Assign a unique name for each profile.
APN	Access Point Name of the network operator. Contact your network operator for more information When you are using a CDMA network, the APN field does not appear.
Username	Username. Contact your network operator for more information
Password	Password. Contact your network operator for more information
DNS	Domain Name Server. Contact your network operator for more information. When Use Automatic DNS-settings is selected, no additional DNS entries are required. Otherwise, enter the DNS addresses.
Proxy Settings	Proxy Settings for your network. Contact your network operator for more information. When Use Proxy Server is selected, no additional proxy entries are required. Otherwise, enter the Proxy and the Port.

Network Tab

The appearance of the network tab depends on the type of firmware selected.

Network with SIM Card

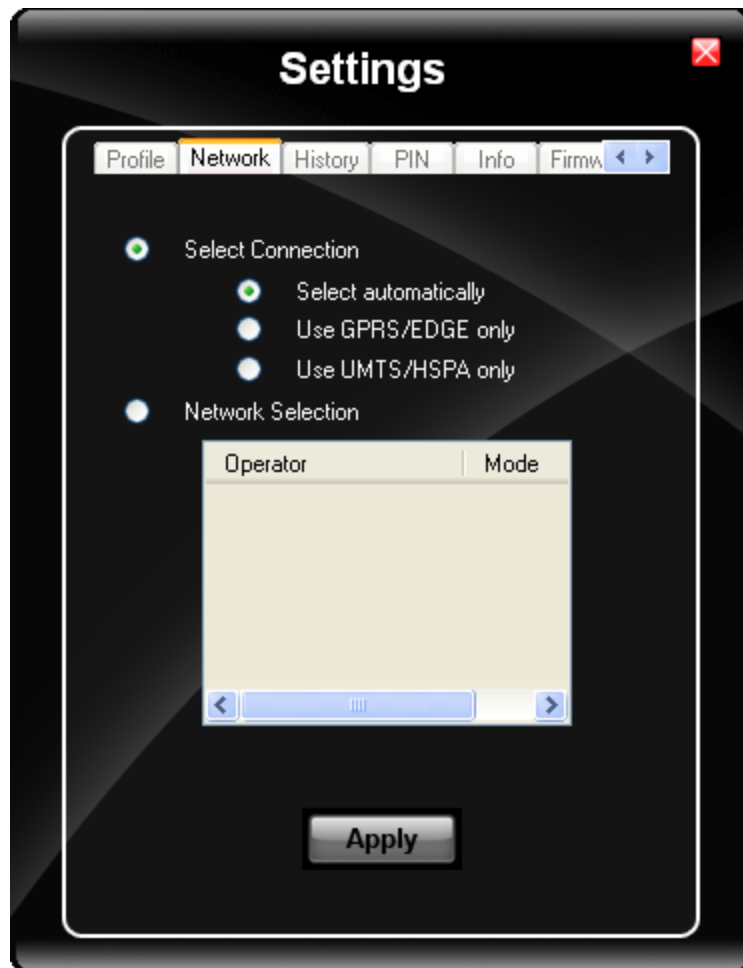

Select Connection

Label	Description
Select automatically	Selects the best suited network automatically
Only use GPRS	Use only GPRS for a connection
Only use UMTS/HSPA	Use only UMTS/HSPA for a connection.

Select and tap **Apply**. A "Network changed successfully" message is displayed.

Close the tab and view the signal strength icon in the main window. Once the signal strength is displayed, you can establish a connection.

Select Network

Use this option to select from available networks.

Note: When you are registered to a CDMA network, you cannot select the network. "All CDMA network" is shown instead.

Note: The network list only appears if the connection setting is **Only use GPRS** or **Only use UMTS/HSPA**.

Select the network and tap on the register button. If the change is successful you will see the message "Network changed successfully".

This item is useful when traveling . Automatic mode selects the preferred network of your network operator.

If enabled, Network Selection displays a list of network options.

1. Automatic Selection
2. Retrieving Networks...

The currently registered network is marked.

CDMA Network

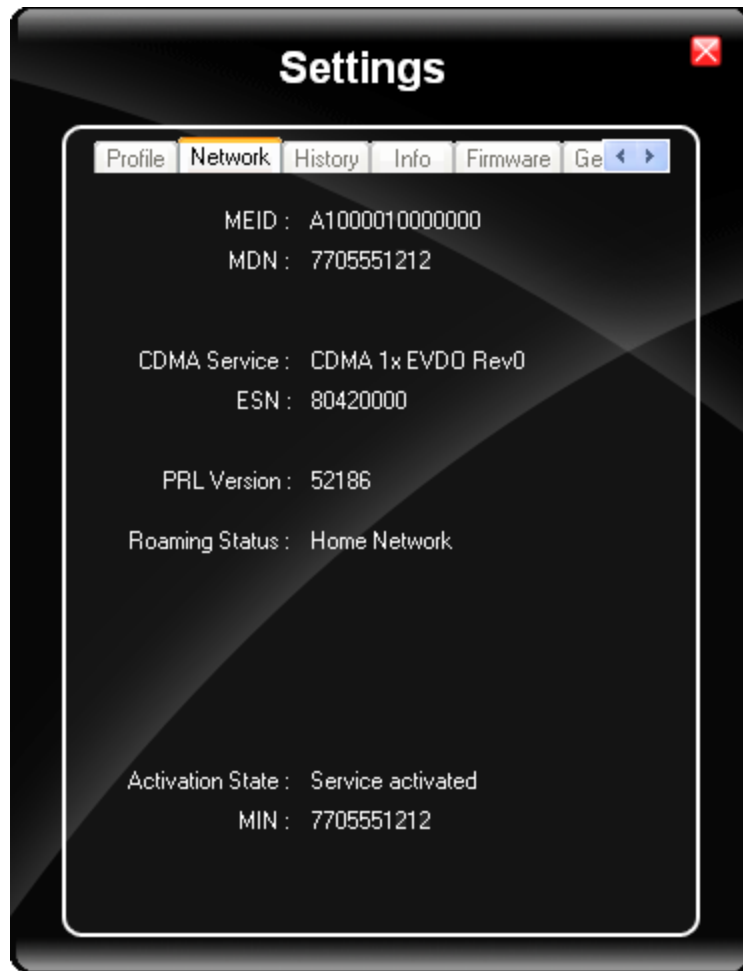

Information on the CDMA network is displayed. There are no editable parameters on this screen.

History Tab



The history shows the data volume transferred in a specified time frame. Select the **From** and **To** dates to see the data volume sent/received in the specified period. Tap **Reset** to reset the counter.

PIN Tab

You can Activate/Deactivate the PIN or Change the PIN.

Activate/Deactivate PIN

This tab is only displayed when a firmware is loaded that requires a SIM card (such as AT&T or T-Mobile).

By default, you have to enter the PIN each time you start WebToGo OneClick Internet using a modem card. Deactivate the PIN to avoid entering the PIN each time.

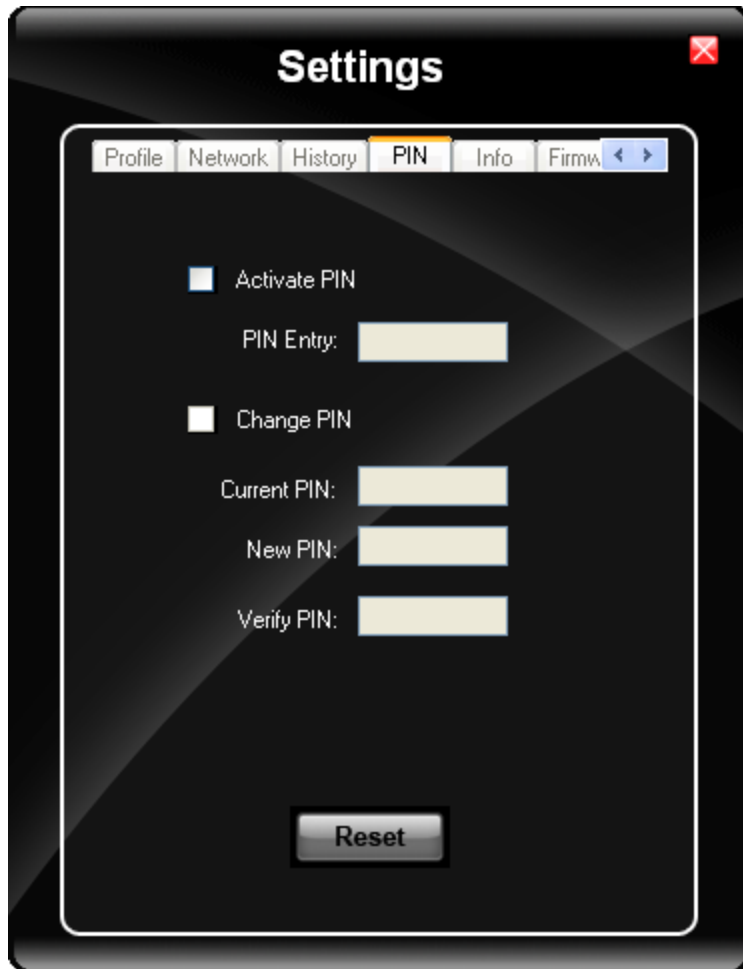

Change PIN

This dialog lets you change your PIN.

Label	Description
Current PIN	Enter the current PIN.
New PIN	Enter the new PIN.
Verify PIN	Verify the new PIN by entering it again.

Info Tab



This tab displays SIM card, modem and system Information.

Firmware Tab



OneClick Internet selects the correct Firmware matching your operator automatically, if a special firmware for your operator is available and a SIM card is inserted. If no specific firmware for your operator is available, generic firmware is selected. After a firmware has been selected, it appears as the **Current Profile**.

You can manually load your desired firmware. Select a new firmware manually by clicking the **Select New Profile** dropdown menu, selecting a firmware from the menu and tapping the **Change** button to load. To return to automatic firmware selection, choose **Automatic(UMTS)** in the dropdown menu.

Note: Switching between CDMA and UMTS firmware is not done automatically. You must select CDMA firmware manually to connect to CDMA networks. If you want to return to UMTS networks, you must manually select UMTS firmware.

Activation on CDMA

When CDMA Firmware is selected, the activation of the modem on the CDMA network starts automatically. During the process of loading CDMA firmware, an activation window pop up allowing a choice between **Manual Activation** and **Automated Activation**.

Label	Description
Manual Activation	Enter the requested items as direct by a representative from your carrier.
Automatic Activation	Use your modem to start an automated activation session

If you cancel the activation or if it fails, you can also start the activation manually by pressing the **Activate** button on the **General** tab.

General Tab

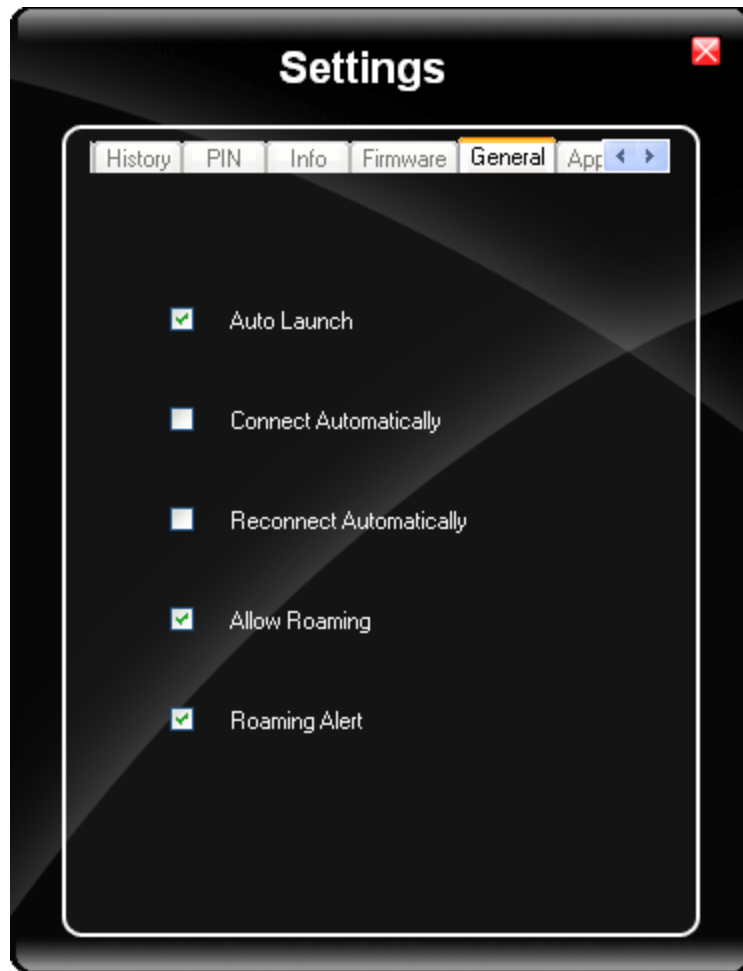

Label	Description
Auto Launch	When selected OneClick Internet launches automatically when the user starts the Thor VX8 and logs in.
Connect Automatically	When selected OneClick Internet automatically connects on start-up.
Reconnect Automatically	When selected OneClick Internet reconnects automatically when the Thor VX8 returns from standby or hibernate.
Allow roaming	When selected OneClick Internet allows connections in foreign networks. <i>Note: Use care when enabling roaming to avoid roaming charges.</i>
Roaming Alert	When selected OneClick Internet displays an alert when roaming.
Gobi NDIS Auto Connect	When selected OneClick Internet connects automatically after powering up the operating system and before the user logs in.

Application Tab

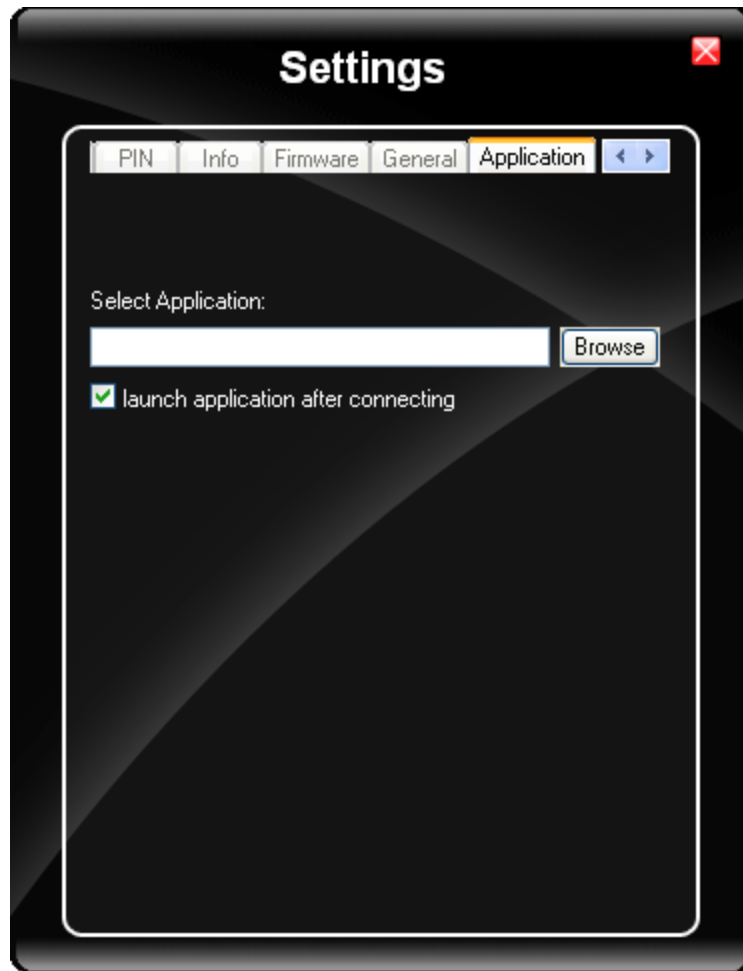

Use the **Application** tab to specify any application to launch automatically once the Internet connection is established. Use the Browse button to locate the desired application.

Application Buttons

SMS

SMS is not supported on the Thor VX8.

Web Browser

Clicking this button opens the Web Browser and allows the user to surf the Internet once the connection is established. The default browser is used, which is Internet Explorer by default on the Thor VX8.

Email

Clicking this button opens the Email application after the connection is established. The Email application is the default Email client set in the Control Panel (**Start > Control Panel > Internet Options > Programs** tab).

GPS

The GPS function is not available on the Thor VX8.



About

OneClick Internet allows the user to configure the WWAN connection by entering basic setup information. The network connection (service carrier) can be chosen based on the firmware loaded.

Once configured, OneClick Internet allows the user to connect or disconnect from the mobile network.

System Requirements

OneClick Internet requires:

- Gobi 2000 3G Module (preinstalled by Honeywell)
- Gobi 2000 Driver package (loaded by Honeywell)

OneClick Internet for Gobi 2000 is compatible with

- Windows XP Professional on the Thor VX8 Atom

Supported Languages

OneClick Internet supports the following languages:

German, English, Spanish, French, Polish, Russian, Italian, simplified Chinese and traditional Chinese.

Note: This does not mean that the Thor VX8 has been localized for these languages.

Installing or Upgrading OneClick Internet

Note: You must use the Honeywell supplied version of OneClick Internet. Do not change versions unless instructed by your Honeywell representative.

When ordered with an OS, One Click Internet is pre-installed by Honeywell before the Thor VX8 is shipped.

If you have an installed version of OneClick Internet and need to update to a newer version, you must uninstall the previous version first by selecting **Start > Control Panel** and select **Add or Remove Programs**. Select **OneClick Internet** and tap **Remove**. Follow the on screen instructions.

Note: OneClick Internet does not install the drivers for the Gobi 2000 devices. Device drivers are preloaded.

Installation

When you double-click the Installer file for OneClick Internet, it extracts the files to install.

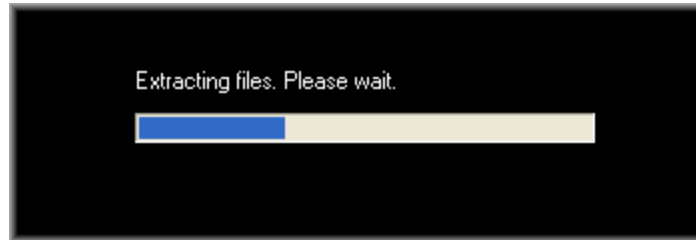

Next, select the application language. By default, the language of the OS is used (if available).

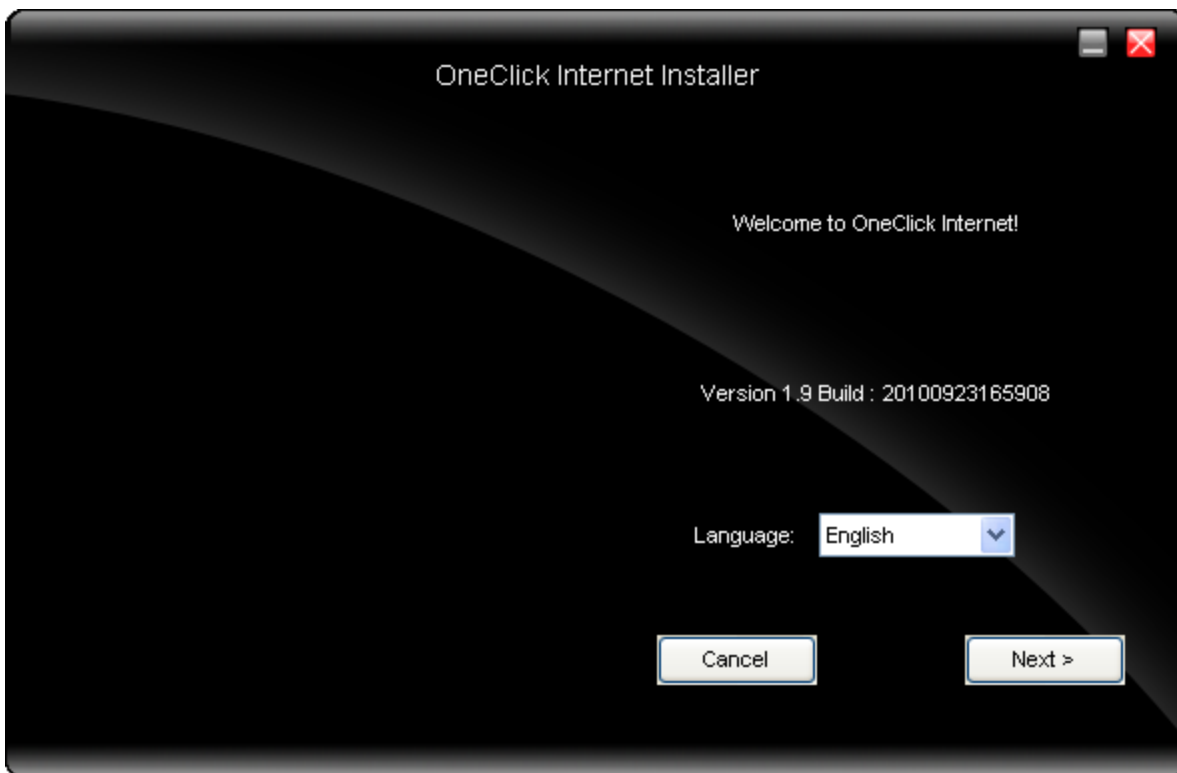

Review and accept the license agreement. Click **Accept**, if you agree. Otherwise please click **Reject** to cancel installation.

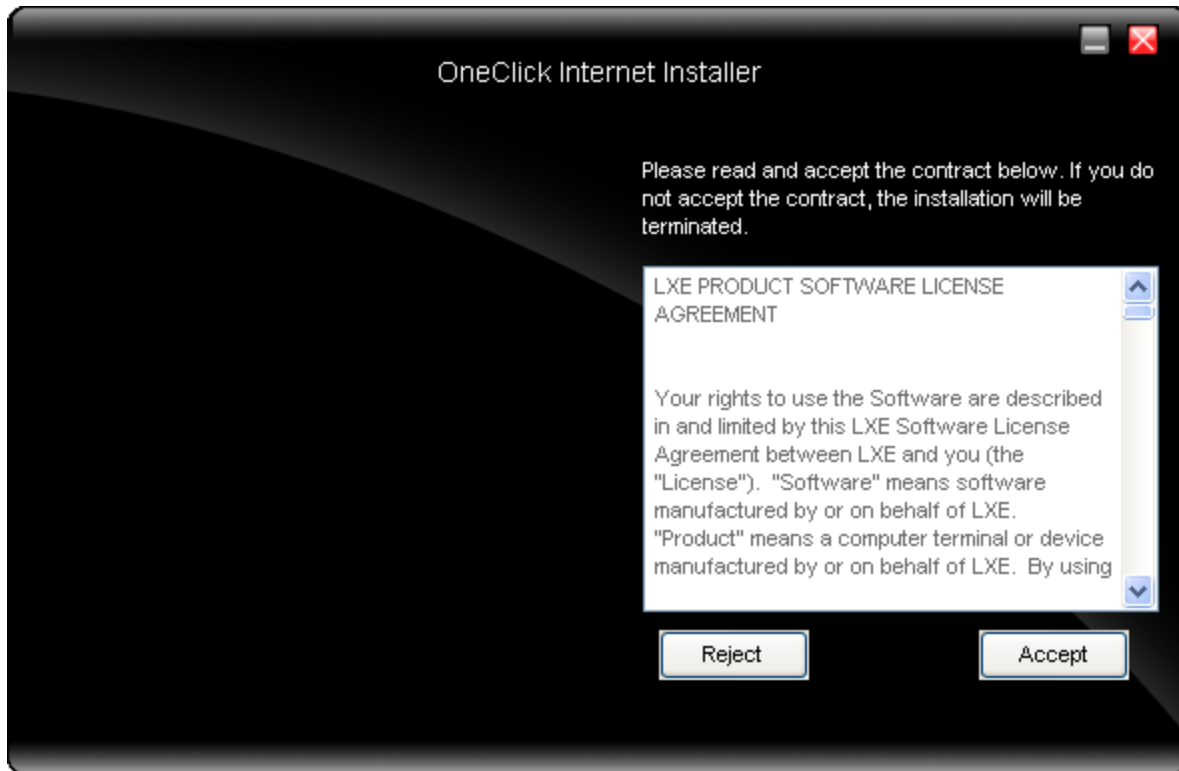

Next the installer asks for the installation directory. Use the **Browse** button to specify a location other than the default.



Installation process is indicated on screen. When completed, click the **Finish** button to exit the installer.



Start OneClick Internet from the Windows Program Menu or double-tap the desktop icon.

OneClick Internet Connection Manager

Launch OneClick Internet from the desktop icon or Windows Start Menu.

When OneClick Internet is active, a status icon appears in the system tray.











The main screen for OneClick Internet opens when the application is started. This screen displays basic information on the connection as well as access to more advanced features and details. From this screen you can connect to the Internet and send Emails. SMS and GPS are not supported

General Windows controls for minimize and exit are located at the upper right of the screen.















Connection Management

Refer to the table below for descriptions of the items in the connection management area.

Icon	Description
	Network signal strength Additionally the network name is displayed to the right of the icon. The more green bars, the stronger the signal.
	Connect / Cancel / Disconnect Tap this button to connect or disconnect. The color of this button also indicates the status of the connection:  Connect The radio is disconnected. Tap the button to connect.  Cancel The radio is currently connecting.  Disconnect The radio is connected. Tap the button to disconnect.

Icon	Description
	SMS SMS is not supported on the Thor VX8.
	Web Tap this button to launch the default browser.
	Email Tap this button to launch the default Email application.
	GPS Tap this button access the integrated GPS tool. GPS is not supported on the Thor VX8.

Information Buttons

Icon	Description
	Radio On/Off Tap this button to switch the radio state . The color of this button also indicates the state of the radio:  The radio is On. Tap the button to turn the radio Off.  The radio is Off. Tap the button to turn the radio On.  The radio is Connecting or the radio has been disabled. The button is inactive at this time.
	Statistics Show/Hide  Tap the button to expand the screen to include connection statistics .  Tap the button to hide the connection statistics.
	Settings Tap this button to access connection settings . Select from several tabs to configure the connection settings.
	Update Tap this button to access OneClick Internet updates .
	Help Click this button to view the on-line help .
Status	 Ready. Tap the Connect button to establish a connection.  Connecting. Tap the Cancel button to cancel the connection in process.  Connected. Tap the Disconnect button to end the connection.  Failure. Review the screen for messages such as "No Network", etc.



Chapter 5: Key Maps

95-key Keypad with Pointing Device

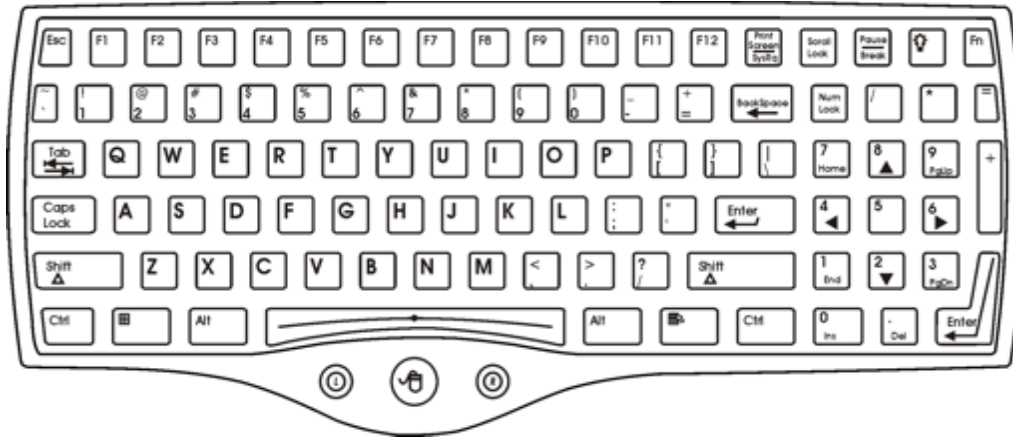

The key map table that follows lists the commands used for the Thor VX8. Note that since the Thor VX8 uses a Microsoft Windows operating system, no DOS Terminal Emulation keypress sequences are provided.

Key Map 101-Key Equivalencies

There are ten hidden keys on the 95-key keyboard. Each of these hidden keys is accessed by pressing the **Fn** key plus another key.

To get this key	Press These Keys and Then
Insert	Fn + 0 on the number pad
Home	Fn + 7 on the number pad
Page Up	Fn + 9 on the number pad
Delete	Fn + . on the number pad
End	Fn + 1 on the number pad
Page Down	Fn + 3 on the number pad
Up Arrow	Fn + 8 on the number pad
Left Arrow	Fn + 4 on the number pad
Down Arrow	Fn + 2 on the number pad
Right Arrow	Fn + 6 on the number pad

Note: The 95-key keyboard does not have a 2nd key function.

60-key Standard Keypad

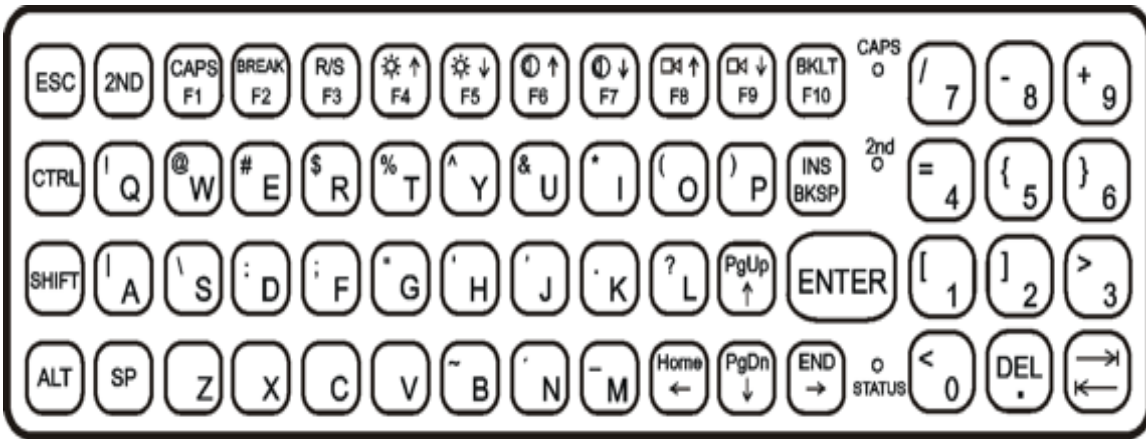

The key map table that follows lists the commands used when using the Thor VX8.

The 60-key keyboard does not have a NumLock indicator or key. NumLock can be toggled On or Off using the **2nd SHIFT F10** keypress sequence. The default for NumLock is On. Changes made to the NumLock status persist across a Windows restart.

When running RFTerm, please refer to the RFTerm Reference Guide for equivalent keys and keypress sequences.

60 Key KeyMap 101-Key Equivalencies

- The following keymap is used on an Thor VX8 that is NOT running RFTerm. RFTerm uses a [separate keymap](#).
- When using a sequence of keys that includes the 2nd key, press the 2nd key first then the rest of the key sequence.
- When the Thor VX8 boots, the default condition of Caps (or CapsLock) is Off. The Caps (or CapsLock) condition can be toggled with a **2nd + F1** key sequence. The CAPS LED is illuminated when CapsLock is On. The keymaps below assume Caps is Off.
- The Thor VX8 keyboard has several control keys. The following control keys are not used:
 - The 2nd function of the **F3** key is not used as Windows Power Management controls all power management modes on the Thor VX8.
 - The 2nd functions of the **F4** and **F5** keys are not used as the display brightness is adjusted via the buttons on the front of the Thor VX8.
 - The 2nd functions of the **F6** and **F7** keys are not used as the Thor VX8 has TFT LCD screen with no provision for contrast adjustments.
 - The 2nd functions of the **F8** and **F9** keys are not used as the *sound volume* on the Thor VX8 is controlled with a Microsoft Windows Control Panel.
 - The 2nd function of the **F10** key is not used as the display backlight timer also controls the keyboard backlight.

To get this Key / Function	Press These Keys in this Order		
Power On/Off	Power		
2nd	2nd		
Shift	Shift		
Alt	Alt		

Ctrl	Ctrl		
Esc	Esc		
Space	Sp		
Enter	Enter		
Enter (numeric)	2nd	Enter	
CapsLock (Toggle)	2nd	F1	
Back Space	BkSp		
Tab	Tab		
Back Tab	2nd	Tab	
Ctrl-Break	Ctrl	2nd	F2
Pause	2nd	F2	
Up Arrow	Up Arrow		
Down Arrow	Down Arrow		
Right Arrow	Right Arrow		
Left Arrow	Left Arrow		
Insert	2nd	Bksp	
Delete (numeric)	2nd	DOT	
Home	2nd	Left Arrow	
End	2nd	Right Arrow	
Page Up	2nd	Up Arrow	
Page Down	2nd	Down Arrow	
ScrollLock	2nd	Shift	F10
F1	F1		
F2	F2		
F3	F3		
F4	F4		
F5	F5		
F6	F6		
F7	F7		
F8	F8		
F9	F9		
F10	F10		
F11	2nd	Shift	F1
F12	2nd	Shift	F2
a	A		

b	B		
c	C		
d	D		
e	E		
f	F		
g	G		
h	H		
i	I		
j	J		
k	K		
l	L		
m	M		
n	N		
o	O		
p	P		
q	Q		
r	R		
s	S		
t	T		
u	U		
v	V		
w	W		
x	X		
y	Y		
z	Z		
A	Shift	A	
B	Shift	B	
C	Shift	C	
D	Shift	D	
E	Shift	E	
F	Shift	F	
G	Shift	G	
H	Shift	H	
I	Shift	I	
J	Shift	J	

K	Shift	K	
L	Shift	L	
M	Shift	M	
N	Shift	N	
O	Shift	O	
P	Shift	P	
Q	Shift	Q	
R	Shift	R	
S	Shift	S	
T	Shift	T	
U	Shift	U	
V	Shift	V	
W	Shift	W	
X	Shift	X	
Y	Shift	Y	
Z	Shift	Z	
1	1		
2	2		
3	3		
4	4		
5	5		
6	6		
7	7		
8	8		
9	9		
0	0		
DOT	DOT		
<	2nd	0	
[2nd	1	
]	2nd	2	
>	2nd	3	
=	2nd	4	
{	2nd	5	
}	2nd	6	
/ (numeric)	2nd	Ctrl	7

/ (alpha)	2nd	7	
- (numeric)	2nd	Ctrl	8
- (alpha)	2nd	8	
+ (numeric)	2nd	Ctrl	9
+ (alpha)	2nd	9	
* (numeric)	2nd	I (letter i)	
* (alpha)	2nd	Ctrl	I (letter i)
: (colon)	2nd	D	
; (semicolon)	2nd	F	
?	2nd	L	
`	2nd	N	
_ (underscore)	2nd	M	
, (comma)	2nd	J	
' (apostrophe)	2nd	H	
~ (tilde)	2nd	B	
\	2nd	S	
	2nd	A	
"	2nd	G	
!	2nd	Q	
@	2nd	W	
#	2nd	E	
\$	2nd	R	
%	2nd	T	
^	2nd	Y	
&	2nd	U	
(2nd	O	
)	2nd	P	

IBM Terminal Emulation

The Thor VX8's IBM 3270 and IBM 5250 Terminal Emulator keypads are designed to allow the user to enter terminal emulator commands when running the RFTerm program. When running RFTerm on the Thor VX8, please refer to RFTerm Webhelp for equivalent keys and keypress sequences.

IBM 3270 Keypad Overlay

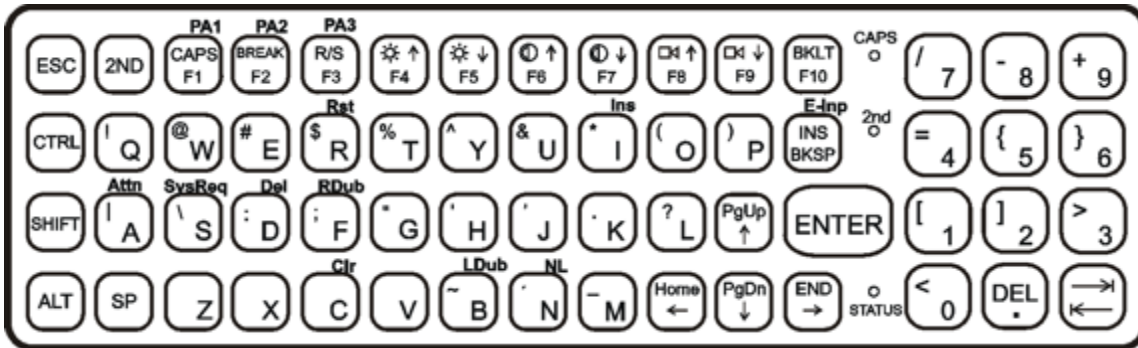

Legend on Keypad	Explanation	Key Sequence
Attn	Attention	Ctrl + A
Clr	Clear	Ctrl + C
Del	Delete	Ctrl + D
E-Inp	Erase Input	Ctrl + BkSp
Ins	Insert	Ctrl + I
NL	New Line	Ctrl + N
PA1		Ctrl + F1
PA2		Ctrl + F2
PA3		Ctrl + F3
Rst	Reset	Ctrl + R
SysReq	System	Ctrl + S

IBM 5250 Keypad Overlay

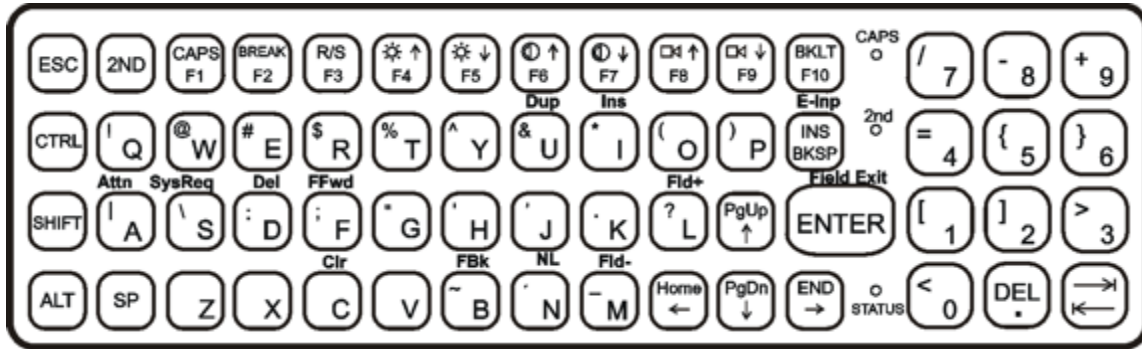

Legend on Keypad	Explanation	Key Sequence
Attn	Attention	Ctrl + A
Clr	Clear	Ctrl + C
Del	Delete	Ctrl + D
Dup	Duplicate	Ctrl + U
E-Inp	Erase Input	Ctrl + Bksp
Field Exit	Enter	Enter
Fld -	Field Minus	Ctrl + M
Fld +	Field Plus	Ctrl + L
Ins	Insert	Ctrl + I
NL	New Line	Ctrl + N
SysReq	System	Ctrl + S

Chapter 6: Technical Specifications

Physical Specifications

Features		Thor VX8B	Thor VX8A
CPU		Intel® 1.6 GHz Atom™ Intel® 1.5 GHz Core™ 2 Duo	Intel® 600 MHz Celeron® Intel® 1.0 GHz Celeron® Intel® 1.4 GHz Pentium® M
BIOS		AMI BIOS	Phoenix BIOS
Memory	RAM	1 or 2 GB SDRAM	512 or 1024MB DDR RAM
Display Controller		SVGA compatible controller	SVGA compatible controller
Mass Storage	Rotating	60 or 80 GB	40 or 60 GB
	Flash	2, 8 or 16 GB	2 or 4 GB
PCMCIA/CardBus Interface		One (1) CardBus Slot (Type 2, optional)	One (1) CardBus Slot (Type 2, optional)
External Connectors/ Interfaces		Two (2) RS-232C serial ports, COM1 and COM2 Two (2) Type A USB 2.0 Ports One (1) Ethernet Port Two (2) PS/2 Ports Multipurpose Connector, USB and/or COM4 via cable Audio Out Microphone In Ethernet Port, RJ-45 10/100	Two (2) RS-232C serial ports, COM1 and COM2 Two (2) Type A USB 2.0 Ports One (1) Ethernet Port Two (2) PS/2 Ports Multipurpose Connector, USB and/or COM4 via cable Audio Out Microphone In Ethernet Port, RJ-45 10/100
Internal Interfaces		Two (2) Mini-PCI One (1) USB 2.0, Type A	Two (2) Mini-PCI One (1) USB 2.0, Type A
Power Connector		Requires DC/DC Power Supply, 9-150V DC specified by DC/DC model selected Integrated UPS battery	Requires DC/DC Power Supply, 9-150V DC specified by DC/DC model selected Integrated UPS battery
Power Switch		Sealed power switch	Sealed power switch
Dimensions		Length: 11.0 in (27.9 cm) Width: 9.0 in (22.9cm) Depth: 3.0 in (7.7 cm)	Length: 11.0 in (27.9 cm) Width: 9.0 in (22.9cm) Depth: 3.0 in (7.7 cm)
Battery for CMOS		Internal lithium Battery	Internal lithium Battery
External Power Supply	AC Adapter	100-240VAC to 12VDC	100-240VAC to 12VDC

Environmental Specifications

The Thor VX8 will withstand the following environmental characteristics and has been tested in accordance with applicable sections of MIL-STD-810E.

Feature	Specification, Thor VX8 B & Thor VX8 A
Operating Temperature	-30°C to +50°C (-22°F to +122°F)
Start Up Temperature	-20°C to +50°C (-4°F to +122°F)
Storage Temperature	-20°C to +50°C (-4°F to +122°F)
Vibration	The unit has been tested according to: EN 60068-2-6 (1995): Sweep 5–200 Hz with 2 g rms acceleration amplitude in 1 hour per axis (x, y, z).
Dust and Water Resistance	Compliant to IEC 60529 IP65

Display Specifications

Characteristic	Thor VX8 B	Thor VX8 A
Display Options	SVGA 10.4" LED backlit indoor display <ul style="list-style-type: none"> • with hardened touch screen • with defroster touch screen SVGA 10.4" LED backlit outdoor display <ul style="list-style-type: none"> • with hardened touch screen 	SVGA 10.4" display <ul style="list-style-type: none"> • with standard touch screen • with hardened touch screen • with defroster touch screen

Operating System

Thor VX8 B	Thor VX8 A
None Windows® 7 Professional Windows® XP Professional SP2 or SP3 Windows® Embedded Standard 2009	None Windows® XP Professional SP2 Windows® XP Embedded

Radio Options

Thor VX8 B	Thor VX8 A
None	None
802.11 a/b/g/n	802.11 b/g
802.11 a/b/g/n & Bluetooth	802.11 a/b/g
802.11 a/b/g/n & WWAN	Bluetooth
802.11a/b/g/n, Bluetooth & WWAN	WWAN
802.11 a/b/g	802.11 b/g & Bluetooth
Bluetooth	802.11 b/g & WWAN
WWAN	802.11 b/g, Bluetooth & WWAN
802.11 a/b/g & Bluetooth	802.11 a/b/g & Bluetooth
802.11 a/b/g & WWAN	802.11 a/b/g & WWAN
802.11a/b/g, Bluetooth & WWAN	802.11a/b/g, Bluetooth & WWAN



Chapter 7: Technical Assistance

If you need assistance installing or troubleshooting your device, please contact us by using one of the methods below:

Knowledge Base: www.hsmknowledgebase.com

Our Knowledge Base provides thousands of immediate solutions. If the Knowledge Base cannot help, our Technical Support Portal (see below) provides an easy way to report your problem or ask your question.

Technical Support Portal: www.hsmsupportportal.com

The Technical Support Portal not only allows you to report your problem, but it also provides immediate solutions to your technical issues by searching our Knowledge Base. With the Portal, you can submit and track your questions online and send and receive attachments.

Web form: www.hsmcontactsupport.com

You can contact our technical support team directly by filling out our online support form. Enter your contact details and the description of the question/problem.

Telephone: www.honeywellaidc.com/locations

For our latest contact information, please check our website at the link above.

Product Service and Repair

Honeywell International Inc. provides service for all of its products through service centers throughout the world. To obtain warranty or non-warranty service, please visit www.honeywellaidc.com and select **Support > Contact Service and Repair** to see your region's instructions on how to obtain a Return Material Authorization number (RMA #). You should do this prior to returning the product.

Limited Warranty

Honeywell International Inc. ("HII") warrants its products to be free from defects in materials and workmanship and to conform to HII's published specifications applicable to the products purchased at the time of shipment. This warranty does not cover any HII product which is (i) improperly installed or used; (ii) damaged by accident or negligence, including failure to follow the proper maintenance, service, and cleaning schedule; or (iii) damaged as a result of (A) modification or alteration by the purchaser or other party, (B) excessive voltage or current supplied to or drawn from the interface connections, (C) static electricity or electro-static discharge, (D) operation under conditions beyond the specified operating parameters, or (E) repair or service of the product by anyone other than HII or its authorized representatives.

This warranty shall extend from the time of shipment for the duration published by HII for the product at the time of purchase ("Warranty Period"). Any defective product must be returned (at purchaser's expense) during the Warranty Period to HII factory or authorized service center for inspection. No product will be accepted by HII without a Return Materials Authorization, which may be obtained by contacting HII. In the event that the product is returned to HII or its authorized service center within the Warranty Period and HII determines to its satisfaction that the product is defective due to defects in materials or workmanship, HII, at its sole option, will either repair or replace the product without charge, except for return shipping to HII.

EXCEPT AS MAY BE OTHERWISE PROVIDED BY APPLICABLE LAW, THE FOREGOING WARRANTY IS IN LIEU OF ALL OTHER COVENANTS OR WARRANTIES, EITHER EXPRESSED OR IMPLIED, ORAL OR WRITTEN, INCLUDING, WITHOUT LIMITATION, ANY IMPLIED WARRANTIES OF MERCHANTABILITY OR FITNESS FOR A PARTICULAR PURPOSE, OR NON-INFRINGEMENT.

HII'S RESPONSIBILITY AND PURCHASER'S EXCLUSIVE REMEDY UNDER THIS WARRANTY IS LIMITED TO THE REPAIR OR REPLACEMENT OF THE DEFECTIVE PRODUCT WITH NEW OR REFURBISHED PARTS. IN NO EVENT

SHALL HII BE LIABLE FOR INDIRECT, INCIDENTAL, OR CONSEQUENTIAL DAMAGES, AND, IN NO EVENT, SHALL ANY LIABILITY OF HII ARISING IN CONNECTION WITH ANY PRODUCT SOLD HEREUNDER (WHETHER SUCH LIABILITY ARISES FROM A CLAIM BASED ON CONTRACT, WARRANTY, TORT, OR OTHERWISE) EXCEED THE ACTUAL AMOUNT PAID TO HII FOR THE PRODUCT. THESE LIMITATIONS ON LIABILITY SHALL REMAIN IN FULL FORCE AND EFFECT EVEN WHEN HII MAY HAVE BEEN ADVISED OF THE POSSIBILITY OF SUCH INJURIES, LOSSES, OR DAMAGES. SOME STATES, PROVINCES, OR COUNTRIES DO NOT ALLOW THE EXCLUSION OR LIMITATIONS OF INCIDENTAL OR CONSEQUENTIAL DAMAGES, SO THE ABOVE LIMITATION OR EXCLUSION MAY NOT APPLY TO YOU.

All provisions of this Limited Warranty are separate and severable, which means that if any provision is held invalid and unenforceable, such determination shall not affect the validity of enforceability of the other provisions hereof. Use of any peripherals not provided by the manufacturer may result in damage not covered by this warranty. This includes but is not limited to: cables, power supplies, cradles, and docking stations. HII extends these warranties only to the first end-users of the products. These warranties are non-transferable.

The duration of the limited warranty for the Thor VX8 is 1 year.

The duration of the limited warranty for the Thor VX8 Vehicle Mount Assembly is 1 year.

The duration of the limited warranty for the Thor VX8 internal UPS battery is 1 year.

The duration of the limited warranty for the Thor VX8 AC power supply and cables is 1 year.

The duration of the limited warranty for the Thor VX8 DC-DC Converter is 1 year.

The duration of the limited warranty for the Thor VX8 cables (USB, Serial, Communication, Power) is 1 year.



Honeywell Scanning & Mobility
9680 Old Bailes Road
Fort Mill, SC 29707
www.honeywellaidc.com

E-EQ-VX8RG
Rev K
10/12